

Measuring Receiver Guide

PSA Series Spectrum Analyzers

Option 233

This manual provides documentation for the following instruments:

Spectrum Analyzers:

E4440A (3 Hz – 26.5 GHz)

E4443A (3 Hz – 6.7 GHz)

E4445A (3 Hz – 13.2 GHz)

E4446A (3 Hz – 44.0 GHz)

E4447A (3 Hz – 42.98GHz)

E4448A (3 Hz – 50.0 GHz)

Systems:

N5531S Measuring Receiver System



Agilent Technologies

Manufacturing Part Number: N5531-90002

Supersedes: N5531-90001

Printed in USA

July 2007

© Copyright 1999 - 2007 Agilent Technologies, Inc.

The information contained in this document is subject to change without notice.

Agilent Technologies makes no warranty of any kind with regard to this material, including but not limited to, the implied warranties of merchantability and fitness for a particular purpose. Agilent Technologies shall not be liable for errors contained herein or for incidental or consequential damages in connection with the furnishing, performance, or use of this material.

1. Introduction	
N5531S Measuring Receiver System Overview	24
N5531S System Block Diagram.	25
What does PSA Option 233 Measuring Receiver Personality Do?	26
Installing Optional Measurement Personalities	27
Do You Have Enough Memory to Load All Your Personality Options?	27
How to Predict Your Memory Requirements	29
Loading an Optional Measurement Personality	31
Obtaining and Installing a License Key	31
Viewing a License Key	32
Using the Delete License Key.	32
Ordering Optional Measurement Personalities	33
Instrument Updates at www.agilent.com	34
2. Installation and Setup	
N5531S System Requirements	37
Measurements Availability vs. Optional Hardware	38
Setting up the System	40
System Hardware Connections	40
System Configuration	43
System Configuration using Using a LAN Cross-over Cable	45
Verifying the System Connections.	47
Calibrating System Components.	48
Load Cal Factors	48
Edit Cal Factors	49
Zero and Calibrate the Power Meter	49
File Operations	50
When to Recalibrate	51
PSA Range Calibration.	52
Protecting Against Electrostatic Discharge	57
3. Making Measurements	
Measuring Receiver Measurements	60
Instrument Front Panel Highlights	61
Selected PSA Front-Panel Features.	62
Mode Setup	64
Frequency Counter Measurement.	65
Measurement Procedure.	66
Frequency Counter Measurement Example	68
RF Power Measurement	69
Measurement Procedure.	69
RF Power Measurement Example	72
Tuned RF Level Measurement	73
Measurement Procedure.	73
Tuned RF Level Measurement Example	80
AM Depth Measurement	81
Measurement Procedure.	81
Measurement Settings	82

Contents

Adjusting the Detector, Auto Carrier Frequency, and High and Low Pass Filters	83
Adjusting the View	84
AM Depth Measurement Example	85
FM Deviation Measurement	86
Measurement Procedure	86
Measurement Settings	87
Adjusting the Detector, Auto Carrier Frequency, and High and Low Pass Filters	88
Adjusting the View	89
FM Deviation Measurement Example	90
PM Deviation Measurement	91
Measurement Procedure	91
Measurement Settings	92
Adjusting the Detector, Auto Carrier Frequency, and High and Low Pass Filters	93
Adjusting the View	94
PM Deviation Measurement Example	95
Modulation Rate Measurement	96
Measurement Procedure	96
Modulation Rate Measurement Example	99
Modulation Distortion Measurement	101
Measurement Procedure	101
Modulation Distortion Measurement Example	103
Modulation SINAD Measurement	105
Measurement Procedure	105
Modulation SINAD Measurement Example	107
Audio Frequency Measurement	109
Measurement Procedure	109
Audio Frequency Measurement Example	111
Audio AC Level Measurement	112
Measurement Procedure	112
Audio AC Level Measurement Example	113
Audio Distortion Measurement	114
Measurement Procedure	114
Audio Distortion Measurement Example	115
Audio SINAD Measurement	116
Measurement Procedure	116
Audio SINAD Measurement Example	117

4. Front-Panel Key and SCPI Command Reference

Programming Command Compatibility	
Across Model Numbers and Across Modes	120
Across PSA Modes: Command Subsystem Similarities	120
Across PSA Modes: Specific Command Differences	122
Using Applications in PSA Series vs. VSA E4406A	123
Front-Panel Keys	125
Det/Demod	125
Power Meter	128
Power Sensor	136
FREQUENCY/Channel	142
Input	143

Meas Control	148
Mode	149
Save/Load File Operations	151
Measure	152
Command Interactions: MEASure, CONFigure, FETCh, INITiate and READ	152
Frequency Counter	156
RF Power	157
Tuned RF Level	158
AM Depth	159
FM Deviation	160
PM Deviation	161
Modulation Rate	162
Modulation Distortion	163
Modulation SINAD	164
Audio Frequency	165
Audio AC Level	166
Audio Distortion	167
Audio SINAD	168
Measurement keys	169
Frequency Counter Measurement	169
RF Power Measurement	175
Tuned RF Level Measurement	180
AM Depth Measurement	189
FM Deviation Measurement	204
PM Deviation Measurement Definition	217
Modulation Rate Measurement	230
Modulation Distortion Measurement	236
Modulation SINAD Measurement	242
Audio Frequency Measurement	248
Audio AC Level Measurement	252
Audio Distortion Measurement	256
Audio SINAD Measurement	260
5. Concepts	
N5531S Block Diagram	266
Frequency Counter Measurements Concepts	267
Purpose	267
Measurement Technique	267
RF Power Measurement Concepts	269
Purpose	269
Measurement Technique	269
Tuned RF Level Measurement Concepts	271
Purpose	271
Measurement Technique	271
Analog Modulation Concepts	276
Modulation Basics	276
AM Depth Measurement Concepts	285
FM Deviation Measurement Concepts	286
PM Deviation Measurement Concepts	286

Contents

Modulation Rate Measurement Concepts	287
Modulation Distortion Measurement Concepts	288
Modulation SINAD Measurement Concepts	289
Audio Measurement Concepts	290
Audio Frequency Measurement Concepts	290
Audio AC Level Measurement Concepts	290
Audio Distortion Measurement Concepts	291
Audio SINAD Measurement Concepts	292
Other Sources of Measurement Information	293
6. Menu Maps	
N5531S Measuring Receiver System Measurement Key Flow	297
Directions for Use	299
7. PC User Interface Measurements	
Introduction	348
Installation and Setup (for PC User Interface only)	349
Setting up the System Hardware	349
Installing the Option 233 PC User Interface Software	350
Verifying the Software Installation	354
Using a GPIB Power Meter in the System	357
Update for N5530S Users	357
Power Meter Requirements	357
PC Requirements	358
8. N5531S Measuring Receiver Performance Verification	
Performance Verification Tests	364
Linearity Verification	365
Relative Tuned RF Level Measurement	371

List of Commands

:CALCulate:TRFLevel:CAF1?	186
:CALCulate:TRFLevel:CAF2?	187
:CALCulate:TRFLevel:CAF3?	187
:CALCulate:TRFLevel:SNR?	187
:CALCulate:TRFLevel:SPO1int?	188
:CALCulate:TRFLevel:SPO2int?	188
:CALibration:PMETer:CALibrate	128
:CALibration:PMETer:CALibrate:STAT?	129
:CALibration:PMETer:NCAL?	134
:CALibration:PMETer:NZERo?	134
:CALibration:PMETer:ZCALibrate	134
:CALibration:PMETer:ZCALibrate:STATe?	135
:CALibration:PMETer:ZERO	135
:CALibration:PMETer:ZERO:STATe?	135
:CONFigure:AMDepth	159
:CONFigure:AUDDist	167
:CONFigure:AUDFreq	165
:CONFigure:AUDLevel	166
:CONFigure:AUDSinad	168
:CONFigure:FCOunter	156
:CONFigure:FMDeviation	160
:CONFigure:MODDist	163
:CONFigure:MODRate	162
:CONFigure:MODSinad	164
:CONFigure:PMDeviation	161
:CONFigure:RFPower	157
:CONFigure:TRFLevel	158
:DISPlay:AMDepth:MODE NORMal RATio	193
:DISPlay:AMDepth:MODE?	193
:DISPlay:AMDepth:RMODE LOG LINear	194
:DISPlay:AMDepth:RMODE?	194

List of Commands

:DISPlay:AMDepth:RREFerence <percent>	194
:DISPlay:AMDepth:RREFerence:AUTO 0 1 OFF ON	194
:DISPlay:AMDepth:RREFerence:AUTO?	194
:DISPlay:AMDepth:RREFerence?	194
:DISPlay:AMDepth:UNIT PCT DB	193
:DISPlay:AMDepth:UNIT?	193
:DISPlay:AMDepth[1] 2:WINDow[1] 2 3 4:TRACe:X[:SCALe]:COUPle 0 1 OFF ON	192
:DISPlay:AMDepth[1] 2:WINDow[1] 2 3 4:TRACe:X[:SCALe]:COUPle?	192
:DISPlay:AMDepth[1] 2:WINDow[1] 2 3 4:TRACe:X[:SCALe]:PDIVision <seconds>	190
:DISPlay:AMDepth[1] 2:WINDow[1] 2 3 4:TRACe:X[:SCALe]:PDIVision?	190
:DISPlay:AMDepth[1] 2:WINDow[1] 2 3 4:TRACe:X[:SCALe]:RLEVel <seconds>	191
:DISPlay:AMDepth[1] 2:WINDow[1] 2 3 4:TRACe:X[:SCALe]:RLEVel?	191
:DISPlay:AMDepth[1] 2:WINDow[1] 2 3 4:TRACe:X[:SCALe] :RPOSition LEFT CENTer RIGHT	191
:DISPlay:AMDepth[1] 2:WINDow[1] 2 3 4:TRACe:X[:SCALe]:RPOSition?	191
:DISPlay:AMDepth[1] 2:WINDow[1] 2 3 4:TRACe:Y[:SCALe]:COUPle 0 1 OFF ON	196
:DISPlay:AMDepth[1] 2:WINDow[1] 2 3 4:TRACe:Y[:SCALe]:COUPle?	196
:DISPlay:AMDepth[1] 2:WINDow[1] 2 3 4:TRACe:Y[:SCALe]:PDIVision <percent>	195
:DISPlay:AMDepth[1] 2:WINDow[1] 2 3 4:TRACe:Y[:SCALe]:PDIVision?	195
:DISPlay:AMDepth[1] 2:WINDow[1] 2 3 4:TRACe:Y[:SCALe]:RLEVel <percent>	195
:DISPlay:AMDepth[1] 2:WINDow[1] 2 3 4:TRACe:Y[:SCALe]:RLEVel?	195
:DISPlay:AMDepth[1] 2:WINDow[1] 2 3 4:TRACe:Y[:SCALe] :RPOSition TOP CENTer BOTTom	196
:DISPlay:AMDepth[1] 2:WINDow[1] 2 3 4:TRACe:Y[:SCALe]:RPOSition?	196
:DISPlay:AUDDist:MODE NORMAl RATIo	257
:DISPlay:AUDDist:MODE?	257
:DISPlay:AUDDist:RMODE LOG LINear	258
:DISPlay:AUDDist:RMODE?	258
:DISPlay:AUDDist:RREFerence <percent>	258
:DISPlay:AUDDist:RREFerence:AUTO 0 1 OFF ON	258
:DISPlay:AUDDist:RREFerence:AUTO?	258
:DISPlay:AUDDist:RREFerence?	258

List of Commands

:DISPlay:AUDDist:UNIT PCT DB	257
:DISPlay:AUDDist:UNIT?	257
:DISPlay:AUDFreq:MODE NORMAl RATIo	248
:DISPlay:AUDFreq:MODE?	248
:DISPlay:AUDFreq:RMODE LOG LINear	250
:DISPlay:AUDFreq:RMODE?	250
:DISPlay:AUDFreq:RREFerence <freq>	249
:DISPlay:AUDFreq:RREFerence:AUTO 0 1 OFF ON	249
:DISPlay:AUDFreq:RREFerence:AUTO?	249
:DISPlay:AUDFreq:RREFerence?	249
:DISPlay:AUDFreq:UNIT HZ KHZ	249
:DISPlay:AUDFreq:UNIT?	249
:DISPlay:AUDLevel:MODE NORMAl RATIo	252
:DISPlay:AUDLevel:MODE?	252
:DISPlay:AUDLevel:RMODE LOG LINear	254
:DISPlay:AUDLevel:RMODE?	254
:DISPlay:AUDLevel:RREFerence <real>	253
:DISPlay:AUDLevel:RREFerence:AUTO 0 1 OFF ON	253
:DISPlay:AUDLevel:RREFerence:AUTO?	253
:DISPlay:AUDLevel:RREFerence?	253
:DISPlay:AUDLevel:UNIT V MV UV	253
:DISPlay:AUDLevel:UNIT?	253
:DISPlay:AUDSinad:MODE NORMAl RATIo	261
:DISPlay:AUDSinad:MODE?	261
:DISPlay:AUDSinad:RMODE LOG LINear	262
:DISPlay:AUDSinad:RMODE?	262
:DISPlay:AUDSinad:RREFerence <rel_ampl>	262
:DISPlay:AUDSinad:RREFerence:AUTO 0 1 OFF ON	262
:DISPlay:AUDSinad:RREFerence:AUTO?	262
:DISPlay:AUDSinad:RREFerence?	262
:DISPlay:AUDSinad:UNIT PCT DB	261

List of Commands

:DISPlay:AUDSinad:UNIT?	261
:DISPlay:FCOunter:MODE NORMAl RATIo	170
:DISPlay:FCOunter:MODE?	170
:DISPlay:FCOunter:RMODE LOG LINear	171
:DISPlay:FCOunter:RMODE?	171
:DISPlay:FCOunter:RREFerence <freq>	171
:DISPlay:FCOunter:RREFerence:AUTO 0 1 OFF ON	171
:DISPlay:FCOunter:RREFerence:AUTO?	171
:DISPlay:FCOunter:RREFerence?	171
:DISPlay:FCOunter:UNIT HZ KHZ MHZ GHZ	170
:DISPlay:FCOunter:UNIT?	170
:DISPlay:FMDeviatiOn:MODE NORMAl RATIo	208
:DISPlay:FMDeviatiOn:MODE?	208
:DISPlay:FMDeviatiOn:RMODE LOG LINear	209
:DISPlay:FMDeviatiOn:RMODE?	209
:DISPlay:FMDeviatiOn:RREFerence <freq>	209
:DISPlay:FMDeviatiOn:RREFerence:AUTO 0 1 OFF ON	209
:DISPlay:FMDeviatiOn:RREFerence:AUTO?	209
:DISPlay:FMDeviatiOn:RREFerence?	209
:DISPlay:FMDeviatiOn:UNIT HZ KHZ	208
:DISPlay:FMDeviatiOn:UNIT?	208
:DISPlay:FMDeviatiOn[1] 2:WINDow[1] 2 3 4:TRACe:X[:SCALe]:COUPlE 0 1 OFF ON ...	207
:DISPlay:FMDeviatiOn[1] 2:WINDow[1] 2 3 4:TRACe:X[:SCALe]:COUPlE?	207
:DISPlay:FMDeviatiOn[1] 2:WINDow[1] 2 3 4:TRACe:X[:SCALe]:PDIVision <seconds>	205
:DISPlay:FMDeviatiOn[1] 2:WINDow[1] 2 3 4:TRACe:X[:SCALe]:PDIVision?	205
:DISPlay:FMDeviatiOn[1] 2:WINDow[1] 2 3 4:TRACe:X[:SCALe]:RLEVel <seconds>	206
:DISPlay:FMDeviatiOn[1] 2:WINDow[1] 2 3 4:TRACe:X[:SCALe]:RLEVel?	206
:DISPlay:FMDeviatiOn[1] 2:WINDow[1] 2 3 4:TRACe:X[:SCALe] :RPOSitiOn LEFT CENTer RIGHt	206
:DISPlay:FMDeviatiOn[1] 2:WINDow[1] 2 3 4:TRACe:X[:SCALe]:RPOSitiOn?	206
:DISPlay:FMDeviatiOn[1] 2:WINDow[1] 2 3 4:TRACe:Y[:SCALe]:COUPlE 0 1 OFF ON ...	211

List of Commands

:DISPlay:FMDeviation[1] 2:WINDow[1] 2 3 4:TRACe:Y[:SCALe]:COUPle?	211
:DISPlay:FMDeviation[1] 2:WINDow[1] 2 3 4:TRACe:Y[:SCALe]:PDIVision <freq>	210
:DISPlay:FMDeviation[1] 2:WINDow[1] 2 3 4:TRACe:Y[:SCALe]:PDIVision?	210
:DISPlay:FMDeviation[1] 2:WINDow[1] 2 3 4:TRACe:Y[:SCALe]:RLEVel <freq>	211
:DISPlay:FMDeviation[1] 2:WINDow[1] 2 3 4:TRACe:Y[:SCALe]:RLEVel?.	211
:DISPlay:FMDeviation[1] 2:WINDow[1] 2 3 4:TRACe:Y[:SCALe] :RPOSition TOP CENTer BOTTom	210
:DISPlay:FMDeviation[1] 2:WINDow[1] 2 3 4:TRACe:Y[:SCALe]:RPOSition?	210
:DISPlay:MODDist:MODE NORMal RATio.	236
:DISPlay:MODDist:MODE?	236
:DISPlay:MODDist:RMODE LOG LINear	238
:DISPlay:MODDist:RMODE?	238
:DISPlay:MODDist:RREFerence <percent>	237
:DISPlay:MODDist:RREFerence:AUTO 0 1 OFF ON.	237
:DISPlay:MODDist:RREFerence:AUTO?	237
:DISPlay:MODDist:RREFerence?	237
:DISPlay:MODDist:UNIT PCT DB.	237
:DISPlay:MODDist:UNIT?	237
:DISPlay:MODRate:MODE NORMal RATio	231
:DISPlay:MODRate:MODE?	231
:DISPlay:MODRate:RMODE LOG LINear	232
:DISPlay:MODRate:RMODE?	232
:DISPlay:MODRate:RREFerence <freq>.	232
:DISPlay:MODRate:RREFerence:AUTO 0 1 OFF ON	232
:DISPlay:MODRate:RREFerence:AUTO?	232
:DISPlay:MODRate:RREFerence?	232
:DISPlay:MODRate:UNIT HZ KHZ	231
:DISPlay:MODRate:UNIT?	231
:DISPlay:MODSinad:MODE NORMal RATio	243
:DISPlay:MODSinad:MODE?	243
:DISPlay:MODSinad:RMODE LOG LINear.	244

List of Commands

:DISPlay:MODSinad:RMODE?	244
:DISPlay:MODSinad:RREFerence <rel_ampl>	244
:DISPlay:MODSinad:RREFerence:AUTO 0 1 OFF ON	244
:DISPlay:MODSinad:RREFerence:AUTO?	244
:DISPlay:MODSinad:RREFerence?	244
:DISPlay:MODSinad:UNIT PCT DB	243
:DISPlay:MODSinad:UNIT?	243
:DISPlay:PMDeviation:MODE NORMAl RATio	220
:DISPlay:PMDeviation:MODE?	220
:DISPlay:PMDeviation:RMODE LOG LINEar	222
:DISPlay:PMDeviation:RMODE?	222
:DISPlay:PMDeviation:RREFerence <degrees>	221
:DISPlay:PMDeviation:RREFerence:AUTO 0 1 OFF ON	221
:DISPlay:PMDeviation:RREFerence:AUTO?	221
:DISPlay:PMDeviation:RREFerence?	221
:DISPlay:PMDeviation:UNIT RAD DEG	221
:DISPlay:PMDeviation:UNIT?	221
:DISPlay:PMDeviation[1] 2:WINDow[1] 2 3 4:TRACe:X[:SCALe]:COUPlE 0 1 OFF ON	220
:DISPlay:PMDeviation[1] 2:WINDow[1] 2 3 4:TRACe:X[:SCALe]:COUPlE?	220
:DISPlay:PMDeviation[1] 2:WINDow[1] 2 3 4:TRACe:X[:SCALe]:PDIVision <seconds>	218
:DISPlay:PMDeviation[1] 2:WINDow[1] 2 3 4:TRACe:X[:SCALe]:PDIVision?	218
:DISPlay:PMDeviation[1] 2:WINDow[1] 2 3 4:TRACe:X[:SCALe]:RLEVel <seconds>	219
:DISPlay:PMDeviation[1] 2:WINDow[1] 2 3 4:TRACe:X[:SCALe]:RLEVel?	219
:DISPlay:PMDeviation[1] 2:WINDow[1] 2 3 4:TRACe:X[:SCALe] :RPOSition LEFT CENTer RIGHt	219
:DISPlay:PMDeviation[1] 2:WINDow[1] 2 3 4:TRACe:X[:SCALe]:RPOSition?	219
:DISPlay:PMDeviation[1] 2:WINDow[1] 2 3 4:TRACe:Y[:SCALe]:COUPlE 0 1 OFF ON	224
:DISPlay:PMDeviation[1] 2:WINDow[1] 2 3 4:TRACe:Y[:SCALe]:COUPlE?	224
:DISPlay:PMDeviation[1] 2:WINDow[1] 2 3 4:TRACe:Y[:SCALe]:PDIVision <angle>	222
:DISPlay:PMDeviation[1] 2:WINDow[1] 2 3 4:TRACe:Y[:SCALe]:PDIVision?	222
:DISPlay:PMDeviation[1] 2:WINDow[1] 2 3 4:TRACe:Y[:SCALe]:RLEVel <angle>	223

List of Commands

:DISPlay:PMDeviation[1] 2:WINDow[1] 2 3 4:TRACe:Y[:SCALe]:RLEVel?	223
:DISPlay:PMDeviation[1] 2:WINDow[1] 2 3 4:TRACe:Y[:SCALe] :RPOSition TOP CENTer BOTTom	223
:DISPlay:PMDeviation[1] 2:WINDow[1] 2 3 4:TRACe:Y[:SCALe]:RPOSition?	223
:DISPlay:RFPower:MODE NORMAl RATio	176
:DISPlay:RFPower:MODE?	176
:DISPlay:RFPower:RMODE LOG LINear	177
:DISPlay:RFPower:RMODE?	177
:DISPlay:RFPower:RREFerence <real>	177
:DISPlay:RFPower:RREFerence:AUTO 0 1 OFF ON	177
:DISPlay:RFPower:RREFerence:AUTO?	177
:DISPlay:RFPower:RREFerence?	177
:DISPlay:RFPower:UNIT DBM WATT V	176
:DISPlay:RFPower:UNIT?	176
:DISPlay:TRFLevel:MODE NORMAl RATio	181
:DISPlay:TRFLevel:MODE?	181
:DISPlay:TRFLevel:RMODE LOG LINear	182
:DISPlay:TRFLevel:RMODE?	182
:DISPlay:TRFLevel:RREFerence <real>	182
:DISPlay:TRFLevel:RREFerence:AUTO 0 1 OFF ON	182
:DISPlay:TRFLevel:RREFerence:AUTO?	182
:DISPlay:TRFLevel:RREFerence?	182
:DISPlay:TRFLevel:UNIT DBM WATT V	181
:DISPlay:TRFLevel:UNIT?	181
:DISPlay:WINDow:SELEct 1 2	198
:DISPlay:WINDow:SELEct?	198
:FETCh:AMDepth[n]?	159
:FETCh:AUDDist[n]?	167
:FETCh:AUDFreq[n]?	165
:FETCh:AUDLevel[n]?	166
:FETCh:AUDSinad[n]?	168

List of Commands

:FETCh:FCOunter[n]?	156
:FETCh:FMDeviation[n]?	160
:FETCh:MODDist[n]?	163
:FETCh:MODRate[n]?	162
:FETCh:MODSinad[n]?	164
:FETCh:PMDeviation[n]?	161
:FETCh:RFPower[n]?	157
:FETCh:TRFLevel[n]?	158
:INITiate:AMDepth	159
:INITiate:AUDDist	167
:INITiate:AUDFreq	165
:INITiate:AUDLevel	166
:INITiate:AUDSinad	168
:INITiate:CONTinuous OFF ON	148
:INITiate:FCOunter	156
:INITiate:FMDeviation	160
:INITiate:MODDist	163
:INITiate:MODRate	162
:INITiate:MODSinad	164
:INITiate:PMDeviation	161
:INITiate:RFPower	157
:INITiate:TRFLevel	158
:INSTrument:NSElect 233	150
:INSTrument:NSElect?	150
:INSTrument[:SElect] SA PNOISE BASIC CDMA CDMA2K EDGE GSM NADC PDC WCDMA CDMA1XEV NFIGURE WLAN MRECEIVE	149
:INSTrument[:SElect]?	149
:MEASure:AMDepth[n]?	159
:MEASure:AUDDist[n]?	167
:MEASure:AUDFreq[n]?	165
:MEASure:AUDLevel[n]?	166

List of Commands

:MEASure:AUDSinad[n]?	168
:MEASure:FCOunter[n]?	156
:MEASure:FMDeviation[n]?	160
:MEASure:MODDist[n]?	163
:MEASure:MODRate[n]?	162
:MEASure:MODSinad[n]?	164
:MEASure:PMDeviation[n]?	161
:MEASure:RFPower[n]?	157
:MEASure:TRFLevel[n]?	158
:MMEMory:LOAD:PSCFactor <'file_name'>.	151
:MMEMory:STORe:PSCFactor <'file_name'>.	151
:READ:AMDepth[n]?	159
:READ:AUDDist[n]?	167
:READ:AUDFreq[n]?	165
:READ:AUDLevel[n]?	166
:READ:AUDSinad[n]?	168
:READ:FCOunter[n]?	156
:READ:FMDeviation[n]?	160
:READ:MODDist[n]?	163
:READ:MODRate[n]?	162
:READ:MODSinad[n]?	164
:READ:PMDeviation[n]?	161
:READ:RFPower[n]?	157
:READ:TRFLevel[n]?	158
:SYSTem:CFActor:DALL	137
:SYSTem:CFActor:NPS <real>,<real>{,<real>,<real>}	136
:SYSTem:CFActor:RST <real>,<real>{,<real>,<real>}	140
:SYSTem:COMMunicate:PMETer:CHANnel:SElect A B	129
:SYSTem:COMMunicate:PMETer:CHANnel:SElect?	129
:SYSTem:COMMunicate:PMETer:CONNection LAN LG	130
:SYSTem:COMMunicate:PMETer:CONNection?	130

List of Commands

:SYSTem:COMMunicate:PMETer:FW:VERsion?	131
:SYSTem:COMMunicate:PMETer:GPIB:ADDRes <integer>.	131
:SYSTem:COMMunicate:PMETer:GPIB:ADDRes?	131
:SYSTem:COMMunicate:PMETer:GPIB:LOGical:UNIT	131
:SYSTem:COMMunicate:PMETer:GPIB:LOGical:UNIT?	131
:SYSTem:COMMunicate:PMETer:IP <string>.	130
:SYSTem:COMMunicate:PMETer:IP?.	130
:SYSTem:COMMunicate:PMETer:MODEL?.	130
:SYSTem:COMMunicate:PMETer:OPTions?	132
:SYSTem:COMMunicate:PMETer:RESolution D001 D01	132
:SYSTem:COMMunicate:PMETer:RESolution?	132
:SYSTem:COMMunicate:PMETer:SNUMber?	132
:SYSTem:COMMunicate:PMETer:TCONnect	133
:SYSTem:COMMunicate:PMETer:TCONnect:STATe?.	134
:SYSTem:COMMunicate:PMETer:TCONnect:TOUT <time>	133
:SYSTem:COMMunicate:PMETer:TCONnect:TOUT?	133
:SYSTem:PSENSor:CLR.	137
:SYSTem:PSENSor:DDATe <Integer>.	136
:SYSTem:PSENSor:DDATe:STRing?	137
:SYSTem:PSENSor:DDATe?.	136
:SYSTem:PSENSor:MNUMber <string>.	139
:SYSTem:PSENSor:MNUMber?.	139
:SYSTem:PSENSor:OPTion <string>	139
:SYSTem:PSENSor:OPTion?	139
:SYSTem:PSENSor:RCF <real>.	140
:SYSTem:PSENSor:RCF?.	140
:SYSTem:PSENSor:RECDefault	139
:SYSTem:PSENSor:SNUMber <string>	141
:SYSTem:PSENSor:SNUMber?	141
:SYSTem:PSENSor:UDEFault.	141
[:SENSe]:AMDepth:AVERage:COUNt <integer> [:SENSe]:AMDepth:AVERage:COUNt?	200

List of Commands

[[:SENSe]:AMDepth:AVERage:TYPE REP EXP	201
[[:SENSe]:AMDepth:AVERage:TYPE?	201
[[:SENSe]:AMDepth:AVERage[:STATe] OFF ON 0 1	200
[[:SENSe]:AMDepth:AVERage[:STATe]?	200
[[:SENSe]:AMDepth:BANDwidth BWIDth <freq>	199
[[:SENSe]:AMDepth:BANDwidth BWIDth:TYPE MIN AUTO MAN	200
[[:SENSe]:AMDepth:BANDwidth BWIDth:TYPE?	200
[[:SENSe]:AMDepth:BANDwidth BWIDth?	199
[[:SENSe]:AMDepth:CAPTure <seconds>	202
[[:SENSe]:AMDepth:CAPTure:AUTO 0 1 ON OFF	202
[[:SENSe]:AMDepth:CAPTure:AUTO?	202
[[:SENSe]:AMDepth:CAPTure?	202
[[:SENSe]:AMDepth:FAST 0 1 OFF ON	203
[[:SENSe]:AMDepth:FAST?	203
[[:SENSe]:AMDepth:ONLY YES NO	203
[[:SENSe]:AMDepth:ONLY?	203
[[:SENSe]:AMDepth:TRIGger:SOURce IMMediate IF EXTernal[1] 	202
[[:SENSe]:AMDepth:TRIGger:SOURce?	202
[[:SENSe]:AUDDist:AVERage:COUNt <integer> [[:SENSe]:AUDDist:AVERage:COUNt?	259
[[:SENSe]:AUDDist:AVERage:TYPE REP EXP	259
[[:SENSe]:AUDDist:AVERage:TYPE?	259
[[:SENSe]:AUDDist:AVERage[:STATe] OFF ON 0 1	259
[[:SENSe]:AUDDist:AVERage[:STATe]?	259
[[:SENSe]:AUDFreq:AVERage:COUNt <integer>	251
[[:SENSe]:AUDFreq:AVERage:COUNt?	251
[[:SENSe]:AUDFreq:AVERage:TYPE REP EXP	250
[[:SENSe]:AUDFreq:AVERage:TYPE?	250
[[:SENSe]:AUDFreq:AVERage[:STATe] OFF ON 0 1	251
[[:SENSe]:AUDFreq:AVERage[:STATe]?	251
[[:SENSe]:AUDLevel:AVERage:COUNt <integer> [[:SENSe]:AUDLevel:AVERage:COUNt?	255

List of Commands

[[:SENSe]:AUDLevel:AVERage:TYPE REP EXP	254
[[:SENSe]:AUDLevel:AVERage:TYPE?	254
[[:SENSe]:AUDLevel:AVERage[:STATe] OFF ON 0 1	255
[[:SENSe]:AUDLevel:AVERage[:STATe]?	255
[[:SENSe]:AUDSinad:AVERage:COUNT <integer> [[:SENSe]:AUDSinad:AVERage:COUNT?	263
[[:SENSe]:AUDSinad:AVERage:TYPE REP EXP	263
[[:SENSe]:AUDSinad:AVERage:TYPE?	263
[[:SENSe]:AUDSinad:AVERage[:STATe] OFF ON 0 1	263
[[:SENSe]:AUDSinad:AVERage[:STATe]?	263
[[:SENSe]:CORRection [:RF]:LOSS <rel_power>	143
[[:SENSe]:CORRection [:RF]:LOSS?	143
[[:SENSe]:CORRection[:RF]:LOSS <integer>	146
[[:SENSe]:CORRection[:RF]:LOSS?	146
[[:SENSe]:FCOunter:AVERage:COUNT <integer>	173
[[:SENSe]:FCOunter:AVERage:COUNT?	173
[[:SENSe]:FCOunter:AVERage:TYPE REP EXP	173
[[:SENSe]:FCOunter:AVERage:TYPE?	173
[[:SENSe]:FCOunter:AVERage[:STATe] OFF ON 0 1	173
[[:SENSe]:FCOunter:AVERage[:STATe]?	173
[[:SENSe]:FCOunter:GAUTo 0 1 OFF ON	172
[[:SENSe]:FCOunter:GAUTo?	172
[[:SENSe]:FCOunter:GLENgtH <time>	172
[[:SENSe]:FCOunter:GLENgtH?	172
[[:SENSe]:FCOunter:RBW <freq>	174
[[:SENSe]:FCOunter:RBW?	174
[[:SENSe]:FCOunter:TAUTo 0 1 OFF ON	172
[[:SENSe]:FCOunter:TAUTo?	172
[[:SENSe]:FCOunter:TFRequency <freq>	172
[[:SENSe]:FCOunter:TFRequency?	172
[[:SENSe]:FEED RF AREFERENCE AUDio AFALign	143
[[:SENSe]:FEED?	143

List of Commands

[[:SENSe]:FMDEv:ONLY?	216
[[:SENSe]:FMDeviation:AVERage:COUNT <integer> [[:SENSe]:FMDeviation:AVERage:COUNT?	213
[[:SENSe]:FMDeviation:AVERage:TYPE REP EXP	214
[[:SENSe]:FMDeviation:AVERage:TYPE?	214
[[:SENSe]:FMDeviation:AVERage[:STATe] OFF ON 0 1	213
[[:SENSe]:FMDeviation:AVERage[:STATe]?	213
[[:SENSe]:FMDeviation:BANDwidth BWIDth <freq>	212
[[:SENSe]:FMDeviation:BANDwidth BWIDth:TYPE AUTO MAN	213
[[:SENSe]:FMDeviation:BANDwidth BWIDth:TYPE?	213
[[:SENSe]:FMDeviation:BANDwidth BWIDth?	212
[[:SENSe]:FMDev:CAPTure <seconds>	215
[[:SENSe]:FMDev:CAPTure:AUTO 0 1 ON OFF	215
[[:SENSe]:FMDev:CAPTure:AUTO?	215
[[:SENSe]:FMDev:CAPTure?	215
[[:SENSe]:FMDev:FAST 0 1 OFF ON	216
[[:SENSe]:FMDev:FAST?	216
[[:SENSe]:FMDev:ONLY YES NO	216
[[:SENSe]:FMDev:TRIGger:SOURce IMMediate IF EXTernal[1] 	215
[[:SENSe]:FMDev:TRIGger:SOURce?	215
[[:SENSe]:FREQuency:CENTer <freq>	142
[[:SENSe]:FREQuency:CENTer?	142
[[:SENSe]:MODDist:AVERage:COUNT <integer> [[:SENSe]:MODDist:AVERage:COUNT?	240
[[:SENSe]:MODDist:AVERage:TYPE REP EXP	240
[[:SENSe]:MODDist:AVERage:TYPE?	240
[[:SENSe]:MODDist:AVERage[:STATe] OFF ON 0 1	240
[[:SENSe]:MODDist:AVERage[:STATe]?	240
[[:SENSe]:MODDist:BANDwidth BWIDth <bandwidth>	238
[[:SENSe]:MODDist:BANDwidth BWIDth:TYPE MIN AUTO MAN	239
[[:SENSe]:MODDist:BANDwidth BWIDth:TYPE?	239
[[:SENSe]:MODDist:BANDwidth BWIDth?	238

List of Commands

[[:SENSe]:MODDist:FAST 0 1 OFF ON	241
[[:SENSe]:MODDist:FAST?	241
[[:SENSe]:MODRate:AVERage:COUNT <integer>	235
[[:SENSe]:MODRate:AVERage:COUNT?	235
[[:SENSe]:MODRate:AVERage:TYPE REP EXP	234
[[:SENSe]:MODRate:AVERage:TYPE?	234
[[:SENSe]:MODRate:AVERage[:STATe] OFF ON 0 1	235
[[:SENSe]:MODRate:AVERage[:STATe]?	235
[[:SENSe]:MODRate:BANDwidth BWIDth <freq>	233
[[:SENSe]:MODRate:BANDwidth BWIDth:TYPE MIN AUTO MAN	234
[[:SENSe]:MODRate:BANDwidth BWIDth:TYPE?	234
[[:SENSe]:MODRate:BANDwidth BWIDth?	233
[[:SENSe]:MODRate:FAST 0 1 OFF ON	235
[[:SENSe]:MODRate:FAST?	235
[[:SENSe]:MODSinad:AVERage:COUNT <integer> [[:SENSe]:MODSinad:AVERage:COUNT?	246
[[:SENSe]:MODSinad:AVERage:TYPE REP EXP	247
[[:SENSe]:MODSinad:AVERage:TYPE?	247
[[:SENSe]:MODSinad:AVERage[:STATe] OFF ON 0 1	246
[[:SENSe]:MODSinad:AVERage[:STATe]?	246
[[:SENSe]:MODSinad:BANDwidth BWIDth <bandwidth>	245
[[:SENSe]:MODSinad:BANDwidth BWIDth:TYPE MIN AUTO MAN	
[[:SENSe]:MODSinad:BANDwidth BWIDth:TYPE?	246
[[:SENSe]:MODSinad:BANDwidth BWIDth?	245
[[:SENSe]:MRECeive:ARANge R0 R1 R2 R3 R4	147
[[:SENSe]:MRECeive:ARANge?	147
[[:SENSe]:MRECeive:AUDio:ATTenuation <real>	145
[[:SENSe]:MRECeive:AUDio:ATTenuation?	145
[[:SENSe]:MRECeive:DEEMphasis OFF T25 T50 T75 T750	126
[[:SENSe]:MRECeive:DEEMphasis?	126
[[:SENSe]:MRECeive:DETEctor PPEak NPEak PNPeak RMS	125
[[:SENSe]:MRECeive:DETEctor?	125

List of Commands

[[:SENSe]:MRECeive:HPFilter OFF F50 F300	127
[[:SENSe]:MRECeive:HPFilter?	127
[[:SENSe]:MRECeive:LPFILTER OFF F3K F15K F30K F300K	127
[[:SENSe]:MRECeive:LPFILTER?	127
[[:SENSe]:MRECeive:MODulation:TYPE AM FM PM	128
[[:SENSe]:MRECeive:MODulation:TYPE?	128
[[:SENSe]:MRECeive:PHOLD ON OFF 0 1	126
[[:SENSe]:MRECeive:PHOLD?	126
[[:SENSe]:MRECeive:RAUTO OFF ON 0 1	145
[[:SENSe]:MRECeive:RAUTO?	145
[[:SENSe]:PMDEv:ONLY?	229
[[:SENSe]:PMDeviation:AVERage:COUNT <integer> [[:SENSe]:PMDeviation:AVERage:COUNT?	226
[[:SENSe]:PMDeviation:AVERage:TYPE REP EXP	226
[[:SENSe]:PMDeviation:AVERage:TYPE?	226
[[:SENSe]:PMDeviation:AVERage[:STATe] OFF ON 0 1	226
[[:SENSe]:PMDeviation:AVERage[:STATe]?	226
[[:SENSe]:PMDeviation:BANDwidth BWIDth <freq>	225
[[:SENSe]:PMDeviation:BANDwidth BWIDth:TYPE AUTO MAN	225
[[:SENSe]:PMDeviation:BANDwidth BWIDth:TYPE?	225
[[:SENSe]:PMDeviation:BANDwidth BWIDth?	225
[[:SENSe]:PMDev:CAPTure <seconds>	228
[[:SENSe]:PMDev:CAPTure:AUTO 0 1 ON OFF	228
[[:SENSe]:PMDev:CAPTure:AUTO?	228
[[:SENSe]:PMDev:CAPTure?	228
[[:SENSe]:PMDev:FAST 0 1 OFF ON	228
[[:SENSe]:PMDev:FAST?	228
[[:SENSe]:PMDev:ONLY YES NO	229
[[:SENSe]:PMDev:TRIGger:SOURce IMMediate IF EXTernal[1]	227
[[:SENSe]:PMDev:TRIGger:SOURce?	227
[[:SENSe]:POWER:RF:ATTenuation <integer>	145

List of Commands

[:SENSe]:POWer:RF:ATTenuation?	145
[:SENSe]:POWer:RF:GAIN[:STATe] ON OFF 0 1	144
[:SENSe]:POWer:RF:GAIN[:STATe]?	144
[:SENSe]:POWer:RF:MW:PRESelector[:STATe] ON OFF 0 1	144
[:SENSe]:POWer:RF:MW:PRESelector[:STATe]?	144
[:SENSe]:RFPower:AVERAge:COUNT <integer>	178
[:SENSe]:RFPower:AVERAge:COUNT?	178
[:SENSe]:RFPower:AVERAge:TYPE REP EXP	178
[:SENSe]:RFPower:AVERAge:TYPE?	178
[:SENSe]:RFPower:AVERAge[:STATe] OFF ON 0 1	178
[:SENSe]:RFPower:AVERAge[:STATe]?	178
[:SENSe]:RFPower:PMETer:USE YES NO	179
[:SENSe]:RFPower:PMETer:USE?	179
[:SENSe]:TRFLevel:AVERAge:ACCuracy NORM HIGH	183
[:SENSe]:TRFLevel:AVERAge:ACCuracy?	183
[:SENSe]:TRFLevel:CALibrate	185
[:SENSe]:TRFLevel:IFBW H10 H75	183
[:SENSe]:TRFLevel:IFBW?	183
[:SENSe]:TRFLevel:RASWitch AUTO MAN	184
[:SENSe]:TRFLevel:RASWitch?	184
[:SENSe]:TRFLevel:RDELay OFF ON 0 1 	186
[:SENSe]:TRFLevel:RDELay?	186
[:SENSe]:TRFLevel:RHOLD OFF ON 0 1	184
[:SENSe]:TRFLevel:RHOLD?	184
[:SENSe]:TRFLevel:SETRef	185

1 Introduction

This chapter provides overall information on Agilent N5531S Measuring Receiver System, describes the PSA Option 233 Measuring Receiver features, and describes the measurements made by the system.

N5531S Measuring Receiver System Overview

The Agilent N5531S is a Measuring Receiver System. It provides measurement functions for characterizing signals with superior accuracy, repeatability, and traceability as required by metrology and calibration labs.

The N5531S Measuring Receiver System consists of an Agilent PSA Series Spectrum Analyzer with a built-in Measuring Receiver personality (PSA option 233), an Agilent P-Series Power Meter and an N5532A Sensor Module. See [Figure 1-1 on page 24](#).

The N5531S system provides metrology/calibration customers with an ideal tool for calibrating signal generators and step attenuators at RF, microwave, and millimeter wave frequencies. It enables you to employ off-the-shelf, general-purpose instruments to perform measurements with the most stringent requirements in metrology and calibration environments. The built-in audio analysis capability allows you to accurately characterize audio signals. The intuitive PSA-based user interface simplifies the users' learning process. The PSA GPIB interface allows remote system control through the SCPI commands.

PC software included with the measuring receiver system, offers PC-based graphic user interface and batch operation mode as well as a COM API compliant remote user interface.

For information on Hardware and Options dependencies, refer to [“N5531S System Requirements” on page 37](#).

Figure 1-1 N5531S Measuring Receiver System

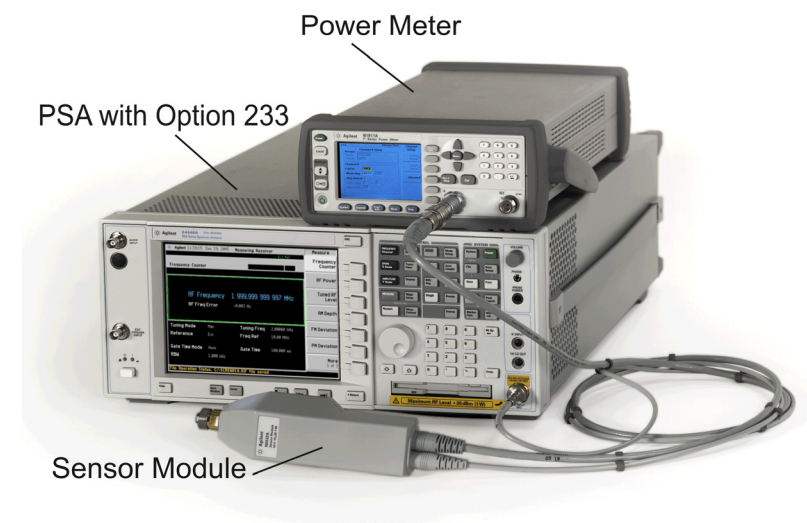

N5531S System Block Diagram

A block diagram of the N5531S Measuring Receiver System is shown below.

The system consists of:

1. PSA with Option 233 (refer to [Table 2-1 on page 37.](#))
1. P-Series Power Meter (refer to [Table 2-2 on page 37.](#))
1. N5532A Sensor Module (refer to [Table 2-3 on page 38.](#))
2. Optional: PC with Measuring Receiver PC User Interface Software installed (refer to [page 349](#), [Table 7-2](#), and [Table 7-3 on page 358.](#))

Figure 1-2 N5531S System Block Diagram

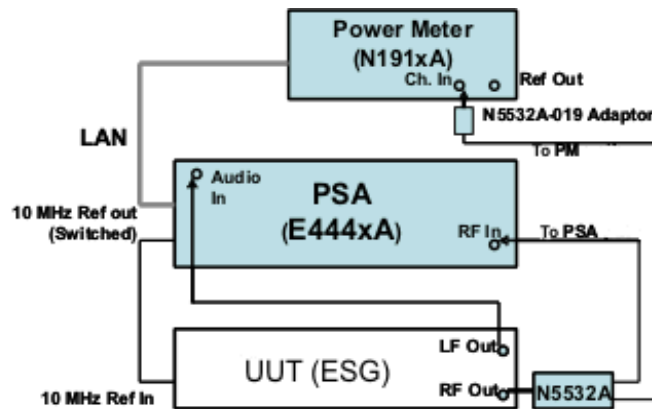

The N5532A Sensor Module receives the incoming RF signal from the DUT and splits it between the Power Meter and PSA. The RF Power and Absolute Tuned RF Level measurements use the sensor module and power meter, whereas all other measurements are performed using the PSA.

What does PSA Option 233 Measuring Receiver Personality Do?

PSA Option 233 is the firmware that controls the N5531S Measuring Receiver System and provides the user interface for the Measuring Receiver personality embedded in PSA. It can make following measurements:

- “[Frequency Counter Measurement](#)” on page 65 - Used to accurately tune to and measure the carrier frequency.
- “[RF Power Measurement](#)” on page 69 - Measures the RMS RF power of the signal by using the Power Meter with a sensor module.
- “[Tuned RF Level Measurement](#)” on page 73 - Measures the absolute or relative levels of continuous wave RF signals to extremely low level.
- “[AM Depth Measurement](#)” on page 81 - Measures the amount of AM of an RF carrier.
- “[FM Deviation Measurement](#)” on page 86 - Measures the frequency deviation of the tuned input signal.
- “[PM Deviation Measurement](#)” on page 91 - Measures the phase deviation of the tuned input signal.
- “[Modulation Rate Measurement](#)” on page 96 - Measures the modulation rate of a modulated AM/FM/PM signal.
- “[Modulation Distortion Measurement](#)” on page 101 - Measures the modulation distortion applied to the modulated signal by comparing the ratio of harmonic and noise power to total power.
- “[Modulation SINAD Measurement](#)” on page 105 - Measures the modulation noise and distortion applied to the modulated signal by calculating the ratio of total power to harmonic and noise power.
- “[Audio Frequency Measurement](#)” on page 109 - Measures the audio frequency of an audio signal applied to the Audio Input port.
- “[Audio AC Level Measurement](#)” on page 112 - Measures the true RMS level of an external signal.
- “[Audio Distortion Measurement](#)” on page 114 - Measures the amount of audio distortion applied to the audio signal by comparing the ratio of harmonic and noise power to fundamental power.
- “[Audio SINAD Measurement](#)” on page 116 - Measures the amount of audio SINAD to the audio signal by comparing the ratio of fundamental power to harmonic and noise power.

Installing Optional Measurement Personalities

When you install a measurement personality, you need to follow a three step process:

1. Determine whether your memory capacity is sufficient to contain all the options you want to load. If not, decide which options you want to install now, and consider upgrading your memory. Details follow in [“Do You Have Enough Memory to Load All Your Personality Options?”](#) on page 27.
2. Install the measurement personality firmware into the instrument memory. Details follow in [“Loading an Optional Measurement Personality”](#) on page 31.
3. Enter a license key that activates the measurement personality. Details follow in [“Obtaining and Installing a License Key”](#) on page 31.

Adding measurement personalities requires the purchase of an upgrade kit for the desired option. The upgrade kit contains the measurement personality firmware and an entitlement certificate that is used to generate a license key from the internet website. A separate license key is required for each option on a specific instrument serial number and host ID.

For the latest information on Agilent Spectrum Analyzer options and upgrade kits, visit the following web location:

http://www.agilent.com/find/sa_upgrades

Do You Have Enough Memory to Load All Your Personality Options?

If you do not have memory limitations then you can skip ahead to the next section [“Loading an Optional Measurement Personality”](#) on page 31. If after installing your options you get error messages relating to memory issues, you can return to this section to learn more about how to optimize your configuration.

If you have 64 MBytes of memory installed in your instrument, you should have enough memory to install at least four optional personalities, with plenty of memory for data and states.

The optional measurement personalities require different amounts of memory. So the number of personalities that you can load varies. This is also impacted by how much data you need to save. If you are having memory errors you must swap the applications in or out of memory as needed. If you only have 48 MBytes of memory, you can upgrade your

hardware to 64 MBytes.

Additional memory can be added to any PSA Series analyzer by installing Option 115. With this option installed, you can install all currently available measurement personalities in your analyzer and still have memory space to store more state and trace files than would otherwise be possible.

To see the size of your installed memory for PSA Series Spectrum Analyzers:

1. Ensure that the spectrum analyzer is in spectrum analyzer mode because this can affect the screen size.
2. Press **System, Show System**. Under Options look for 115.
3. Press **System, More, Show Hdwr**.
4. Read Flash Memory size in the table.

PSA Flash Memory Size	Available Memory Without Option B7J and Option 122 or 140	Available Memory With Option B7J and Option 122 or 140
64 Mbytes	32.5 MBytes	30.0 MBytes
48 Mbytes	16.9 MBytes	14.3 MBytes

PSA Compact Flash Memory Size	Available Additional Memory for Measurement Personalities
512 Mbytes (Opt. 115)	512 MBytes

If you have 48 MBytes of memory, and you want to install more than 3 optional personalities, you may need to manage your memory resources. The following section, [“How to Predict Your Memory Requirements” on page 29](#), will help you decide how to configure your installed options to provide optimal operation.

How to Predict Your Memory Requirements

If you plan to install many optional personalities, you should review your memory requirements, so you can determine whether you have enough memory (unless you have a PSA Series with Option 115). There is an Agilent “Memory Calculator” available online that can help you do this, or you can make a calculated approximation using the information that follows. You will need to know your instrument’s installed memory size as determined in the previous section and then select your desired applications.

NOTE If you have a PSA Series analyzer with Option 115, there is adequate memory to install all of the available optional personalities in your instrument.

To calculate the available memory on your PSA, see:
<http://sa.tm.agilent.com/PSA/memory/>

Select the “Memory Calculator” link. You can try any combination of available personalities to see if your desired configuration is compatible with your installed memory.

NOTE After loading all your optional measurement personalities, you should have a reserve of ~2 MBytes memory to facilitate mode switching. Less available memory will increase mode switching time. For example, if you employ excessive free memory by saving files of states and/or data, your mode switching time can increase to more than a minute.

You can manually estimate your total memory requirements by adding up the memory allocations described in the following steps. Compare the desired total with the available memory that you identified in the previous section.

1. Program memory - Select option requirements from the table “[Measurement Personality Options and Memory Required](#)” on page 30.
2. Shared libraries require 7.72 MBytes.
3. Recommended mode swap space is 2 MBytes.
4. Screens - .gif files need 20-25 kBytes each.
5. State memory - State file sizes range from 21 kB for SA mode to 40 kB for W-CDMA. The state of every mode accessed since power-on will be saved in the state file. File sizes can exceed 150 kB each when several modes are accessed, for each state file saved.

TIP State memory retains settings for all states accessed before the **Save State** command. To reduce this usage to a minimum, reduce the modes accessed before the **Save State** is executed. You can set the PSA to boot into a selected mode by accessing the desired mode, then pressing the **System, Power On/Preset, Power On** keys and toggle the setting to **Last**.

Measurement Personality Options and Memory Required

Personality Options for PSA Series Spectrum Analyzers ^a	Option	File Size (PSA Rev: A.10)
cdmaOne measurement personality	BAC	1.91 Mbytes
NADC and PDC measurement personalities (not available separately)	BAE	2.43 Mbytes
W-CDMA or W-CDMA, HSDPA, HSUPA measurement personality	BAF, 210	5.38 Mbytes ^b
cdma2000 or cdma2000 w/ 1xEV-DV measurement personality	B78, 214	4.00 Mbytes ^b
1xEV-DO measurement personality	204	5.61 Mbytes ^b
GSM (with EDGE) measurement personality	202	3.56 Mbytes ^b
Shared measurement library ^b	n/a	7.72 Mbytes
Phase Noise measurement personality	226	2.82 Mbytes ^c
Noise Figure measurement personality	219	4.68 Mbytes ^c
Basic measurement personality with digital demod hardware	B7J	Cannot be deleted (2.64 Mbytes)
Programming Code Compatibility Suite ^d (8560 Series, 8590 Series, and 8566/8568)	266	1.18 Mbytes ^c
TD-SCDMA Power measurement personality	211	5.47 Mbytes ^c
TD-SCDMA Modulation Analysis or TD-SCDMA Modulation Analysis w/ HSDPA/8PSK measurement personality	212, 213	1.82 Mbytes
Flexible Digital Modulation Analysis	241	2.11 Mbytes ^b
WLAN measurement personality	217	3.24 Mbytes ^b
External Source Control	215	0.72 Mbytes ^c
Measuring Receiver Personality (available with Option 23A - Trigger support for AM/FM/PM and Option 23B - CCITT filter)	233	2.91 Mbytes ^b
EMC Analyzer	239	4.06 Mbytes ^b

- a. Available as of the print date of this guide.
- b. Many PSA Series personality options use a 7.72 Mbyte shared measurement library. If you are loading multiple personalities that use this library, you only need to add this memory allocation once.
- c. Shared measurement library allocation not required.
- d. This is a no charge option that does not require a license key.

Memory Upgrade Kits

The PSA 64 MByte Memory Upgrade kit part number is E4440AU-ANE. The PSA Compact Flash Upgrade kit part number is E4440AU-115.

For more information about memory upgrade kits contact your local sales office, service office, or see:

http://www.agilent.com/find/sa_upgrades

Loading an Optional Measurement Personality

You must use a PC to load the desired personality option into the instrument memory. Loading can be done from a firmware CD-ROM or by downloading the update program from the internet. An automatic loading program comes with the files and runs from your PC.

You can check the Agilent internet website for the latest PSA firmware versions available for downloading:

http://www.agilent.com/find/psa_firmware

NOTE

When you add a new option, or update an existing option, you will get the updated versions of all your current options as they are all reloaded simultaneously. This process may also require you to update the instrument core firmware so that it is compatible with the new option.

Depending on your installed hardware memory, you may not be able to fit all of the available measurement personalities in instrument memory at the same time. You may need to delete an existing option file from memory and load the one you want. Use the automatic update program that is provided with the files. Refer to the table showing [“Measurement Personality Options and Memory Required” on page 30](#). The approximate memory requirements for the options are listed in this table. These numbers are worst case examples. Some options share components and libraries, therefore the total memory usage of multiple options may not be exactly equal to the combined total.

Obtaining and Installing a License Key

If you purchase an optional personality that requires installation, you will receive an “Entitlement Certificate” which may be redeemed for a license key specific to one instrument. Follow the instructions that accompany the certificate to obtain your license key.

To install a license key for the selected personality option, use the following procedure:

NOTE

You can also use this procedure to reinstall a license key that has been deleted during an uninstall process, or lost due to a memory failure.

For PSA:

1. Press **System, More, More, Licensing, Option** to access the alpha editor. Use this alpha editor to enter letters (upper-case), and the front-panel numeric keys to enter numbers for the option designation. You will validate your option entry in the active function area of the display. Then, press the **Enter** key.
2. Press **License Key** to enter the letters and digits of your license key. You will validate your license key entry in the active function area of the display. Then, press the **Enter** key.
3. Press the **Activate License** key.

Viewing a License Key

Measurement personalities purchased with your instrument have been installed and activated at the factory before shipment. The instrument requires a **License Key** unique to every measurement personality purchased. The license key is a hexadecimal number specific to your measurement personality, instrument serial number and host ID. It enables you to install, or reactivate that particular personality.

Use the following procedure to display the license key unique to your personality option that is already installed in your PSA:

Press **System, More, More, Licensing, Show License**. The **System, Personality** key displays the personalities loaded, version information, and whether the personality is licensed.

NOTE

*You will want to keep a copy of your license key in a secure location. Press **System, More**, then **Licensing, Show License**, and print out a copy of the display that shows the license numbers. If you should lose your license key, call your nearest Agilent Technologies service or sales office for assistance.*

Using the Delete License Key

This key will make the option unavailable for use, but will not delete it from memory. Write down the 12-digit license key for the option before you delete it. If you want to use that measurement personality later, you will need the license key to reactivate the personality firmware.

NOTE

Using the **Delete License** key does not remove the personality from the instrument memory, and does not free memory to be available to install another option. If you need to free memory to install another option, refer to the instructions for loading firmware updates located at the URL : <http://www.agilent.com/find/psa/>

1. Press **System, More, More, Licensing, Option**. Pressing the **Option** key will activate the alpha editor menu. Use the alpha editor to enter the

letters (upper-case) and the front-panel numeric keyboard to enter the digits (if required) for the option, then press the **Enter** key. As you enter the option, you will see your entry in the active function area of the display.

2. Press **Delete License** to remove the license key from memory.

Ordering Optional Measurement Personalities

When you order a personality option, you will receive an entitlement certificate. You will need to go to the Web site to redeem your entitlement certificate for a license key. You will need to provide your instrument serial number and host ID, and the entitlement certificate number.

Required Information:	Front Panel Key Path:
Model #: (Ex. E4440A)	
Host ID: _____	System, Show System
Instrument Serial Number: _____	System, Show System

Instrument Updates at www.agilent.com

These web locations can be used to access the latest information about the instrument, including the latest software version.

<http://www.agilent.com/find/N5531S>

2

Installation and Setup

This chapter provides information you may need when you first receive your Measuring Receiver System.

The following sections will help you install and setup your Measuring Receiver System:

- “N5531S System Requirements” on page 37
- “Setting up the System” on page 40
- “Verifying the System Connections” on page 47
- “Calibrating System Components” on page 48
- “Protecting Against Electrostatic Discharge” on page 57

N5531S System Requirements

Table 2-1 PSA System Requirements

System Component	Model numbers supported
PSA with Options 233: Measuring Receiver Personality	E4440A, E4443A, E4445A, E4446A, E4447A and E4448A Firmware Revision A.09.18 or later
Additional options required to enhanced performance ^a	<p>Option 123: mw/mmw preselector bypass above 3 GHz (Required for signals above 3 GHz, mutually exclusive with Option AYZ)</p> <p>Option 1DS: RF pre-amplifier below 3 GHz (Highly recommended, mutually exclusive with Option 110)^b</p> <p>Option 110: pre-amplifier (Highly recommended, mutually exclusive with Option 1DS)</p> <p>Option 107: audio input (Required for Audio measurement)</p> <p>Option N5531S-010: LAN connection kit incl. 1 hub and 3 LAN cables</p>

- a. You can also select many other available PSA options. Contact your Agilent sales office for information on options available for your instrument.
- b. PSA Option 1DS and 110 are mutually exclusive. Option 110 covers the frequency range of 10 MHz to the maximum frequency of the PSA. Option 1DS covers 100 kHz to 3 GHz.

Table 2-2 Power Meter System Requirements

System Component	Model numbers supported ^a
P Series Power Meter	N1911A or N1912A

- a. You can use an Agilent EPM or EPM-P Power Meter with a LAN/GPIB Gateway. Contact your Agilent sales office for more information.

Table 2-3 Sensor System Requirements

System Component	Model numbers supported
N5532A Sensor Module	<p>One of the following Options^a (Required):</p> <ul style="list-style-type: none"> — Option 504: 100 kHz to 4.2 GHz — Option 518: 10 MHz to 18.0 GHz — Option 526: 30 MHz to 26.5 GHz — Option 550: 30 MHz to 50.0 GHz <p>Option N5532A-019: Input adapter to N191xA (Required for connecting the Sensor Module with the P-Series Power Meter)</p>

a. Refer to the *N5532A Sensor Module User's and Service Guide* for more information.

Measurements Availability vs. Optional Hardware

Table 2-4, “Measurement Availability vs. Optional Hardware,” on page 39 shows the dependencies between the Measuring Receiver measurements and the required hardware/Options. The hardware discussed here is the Power Meter and the Audio Input (Option 107). Both are optional when using the Option 233 Measuring Receiver personality. However, some features of the measurements will be unavailable if either Power Meter or Audio Input is not available.

In the table, “Y” means the user can make the current measurement; “N” means the user can not make the current measurement; “-” means the measurement does not depend on the hardware.

Table 2-4 Measurement Availability vs. Optional Hardware

Measurements	Power Meter		Audio Input (Option 107)	
	Available	Not Available	Available	Not Available
Frequency Counter	-	-	-	-
RF Power	Y	See ^a	-	-
Tuned RF Level	Y	See ^b	-	-
AM Depth	-	-	-	-
FM Deviation	-	-	-	-
PM Deviation	-	-	-	-
Modulation Rate	-	-	-	-
Modulation Distortion	-	-	-	-
Modulation SINAD	-	-	-	-
Audio Frequency	-	-	Y	N
Audio Distortion	-	-	Y	N
Audio SINAD	-	-	Y	N
Audio AC Level	-	-	Y	N

- a. Power measured by PSA. Accuracy dependent on PSA specifications.
b. Relative Tuned RF Level measurement only.

Setting up the System

NOTE

Before you can begin making any Measuring Receiver measurements, make sure you have Option 233 application firmware installed. In case you have purchased this firmware separately as an optional upgrade, refer to “Installing Optional Measurement Personalities” on page 27.

System Hardware Connections

Step 1. Check your hardware to ensure it has the correct options and features; Refer to the following:

- Table 2-1, “PSA System Requirements,” on page 37
- Table 2-2, “Power Meter System Requirements,” on page 37
- Table 2-3, “Sensor System Requirements,” on page 38

Figure 2-1 Hardware Setup Block Diagram

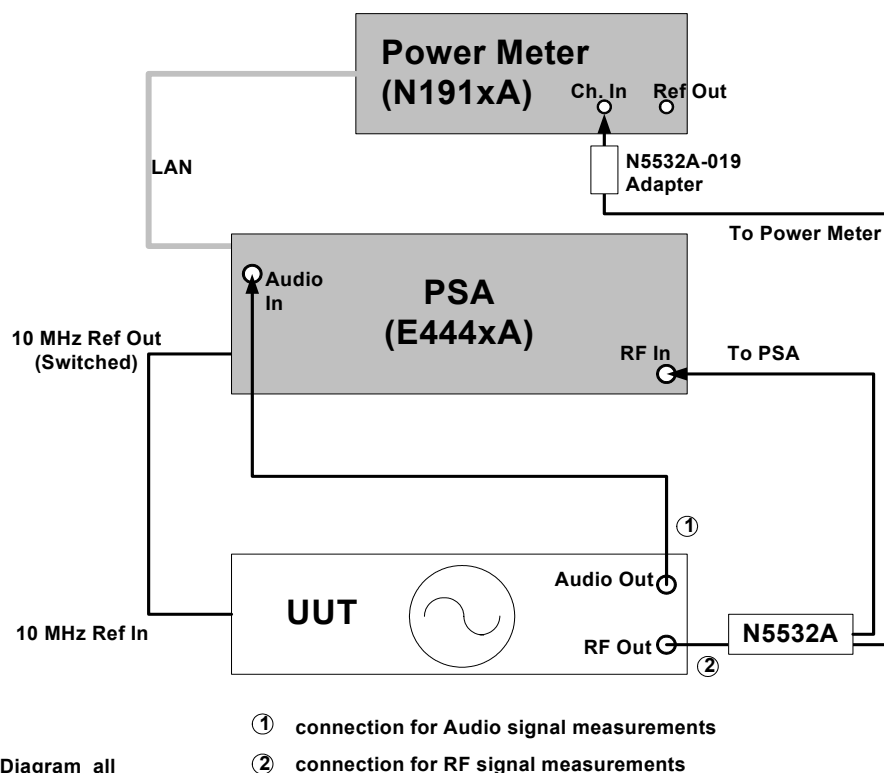

HW_Setup_Block_Diagram_all

Step 2. Setup the N5531S Measuring Receiver system by correctly connecting the PSA, Power Meter, Sensor Module and Unit Under Test (UUT). See Figure 2-1, “Hardware Setup Block Diagram,” on page 40.

Step 3. Connect power cords to the PSA, Power Meter and UUT.

CAUTION

While connecting the sensor module to the UUT, make sure you follow the instructions below:

1. Before connecting a signal to the sensor module, make sure the sensor module can safely accept the signal level provided. See *Sensor Module Users Guide* to view the signal level limits.
 2. Turn only the connector sleeve portion of the sensor module. Damage can occur if torque is applied to the sensor module body.
 3. If possible, ensure the sensor rests flush against a desktop or other support. This helps prevent mechanical damage to the sensor and UUT RF OUT connector. See [Figure 2-3, “Connecting the Sensor Module to the UUT,”](#) on page 41.
 4. Maximum torque at the connector should NOT exceed 12 in-pound (135 Ncm) for the Type-N connector or 8 in-pound (90 Ncm) for the 3.5-mm or 2.4 mm connector to avoid damage to the connector.
-

[Figure 2-1, “Hardware Setup Block Diagram,”](#) on page 40 illustrates the system hardware after being setup and connected with UUT and figures below illustrate some examples of system component and connections.

Figure 2-2 N5532A Sensor Module

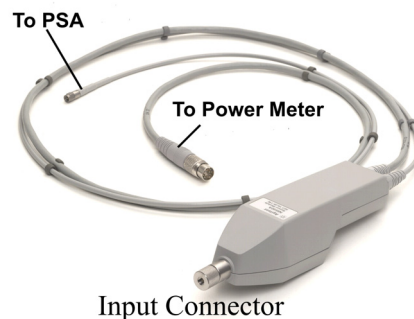

Figure 2-3 Connecting the Sensor Module to the UUT



Table 2-5 **Equipment used in Measurement Examples**

Equipment	Model Number
PSA Series Spectrum Analyzer	Agilent E4440A with Option 233, Option 1DS and Option 107
P Series Power Meter	Agilent N1911A
Sensor Module	Agilent N5532A Option 504
Unit Under Test (UUT)	Agilent E4438C ESG
LAN Connection Kit	Agilent Option N5531S-010
Adapter for N1911A	Agilent Option N5532A-019

NOTE You can use the PC User Interface Software to control the system. See [Chapter 7](#) , “PC User Interface Measurements” on page 347.

System Configuration

Make sure you have setup the system connections.

- Step 1.** Apply power to the PSA and power meter, then wait until they complete the self-tests.
- Step 2.** On the power meter, perform system configurations for power meter.
1. Press **System, Remote Interface, Network Manual**. The first block of the IP address should be highlighted.
 2. Press **Select** and enter the first 3 numbers. Press **Enter**.
 3. Press the right arrow key to move the highlighted area. Press **Select** and enter the next 3 numbers. Press **Enter**.
 4. Continue this process until the complete IP address is entered.
 5. Press the down arrow key and enter the Subnet Mask. (Your network administrator will have the subnet mask information.)
- Step 3.** Perform system configurations for PSA. This is for a system that is configured as shown in [Figure 2-1](#).
1. Press the **MODE** key, select **Measuring Receiver**.
 2. Press **System, Reference, 10 MHz Out** to select **ON** to provide a 10 MHz frequency reference to the UUT. Verify that the UUT is accepting the external reference (Ext Ref).
 3. Press **System, Config I/O, IP Address**, and enter the PSA IP address. Then press **Subnet Mask** to set the PSA subnet mask and **Gateway Address** to set the gateway address. Your network administrator will have these values. You will need to power cycle the PSA after you change these values.
 4. Press the **System, More, More, Power Meter, Power Meter Config** keys.
 5. Press **Conn Mode** to select **LAN** connection mode.
 6. Press the **Power Meter IP Address** and **Subnet** keys. Enter the IP address and subnet address. Make sure the PSA and the power meter are using appropriate IP addresses to communicate.
 7. Press the **Verify Power Meter Connection** key, then the grayed-out **Show Setup** key is enabled when the connection between the PSA and the power meter is established.
 8. Select the power meter channel number you are using by toggling the **Channel** key. If the power meter has only one channel, this key is grayed-out.
 9. Press the **Show Setup** key to display and verify the power meter config information.

10. You can set the desired time-out for your testing by pressing **Power Meter Config, More, Time Out** keys.
11. Press **Power Meter Config, More, Resolution** to select the resolution as 0.001dB or 0.01 dB.

Step 4. Perform system configurations for Sensor Module.

1. Load the Sensor Module Cal Factors. See [“Load Cal Factors” on page 48](#) to load the file CFDATA.XML to the PSA.

NOTE

If you are using a power sensor that does not have a file or data disk containing calibration factors, you may need to input the calibration factors by hand. See [“Edit Cal Factors” on page 49](#).

2. Press the **System, More, More, Power Sensor Config** keys to enter the menu of PS Config.
3. Once you have loaded the Cal Factors file, verify the Sensor Module information, like Model No., Options, Serial No., Cal Date.
4. Press any key in this page to edit and change the parameter if necessary. Your edits will be lost when the PSA power is shut down unless you press **Update Power-On Default** to save. Once saved, the current file with your edits will be loaded by default next time the PSA is powered on.
5. You can press **More, Clear Power Sensor** to clear the Power Sensor information displayed; or press **Recall Power-On Default** to load the default file you saved in memory.

System Configuration using Using a LAN Cross-over Cable

A cross-over cable (CAT-5, RJ-45 cable with cross-pinning) can be used to connect the PSA and P-Series Power Meter if the instruments do not have IP addresses assigned, or if a LAN hub is not available. See following instructions.

- Step 1.** Connect the PSA and power meter using a cross-over cable.
- Step 2.** Apply power to the PSA and power meter, then wait until they complete the self-tests.
- Step 3.** On the power meter, perform system configurations for power meter.
1. Press **System, Remote Interface, Network Manual**. The first block of the IP address should be highlighted, for example 192.168.100.2.
 2. Press **Select** and enter the first 3 numbers. Press **Enter**.
 3. Press the right arrow key to move the highlighted area. Press **Select** and enter the next 3 numbers. Press **Enter**.
 4. Continue this process until the complete IP address is entered.
 5. Press the down arrow key and enter the Subnet Mask, for example 255.255.0.0.
- Step 4.** Perform system configurations for PSA.
1. Press the **MODE** key, select **Measuring Receiver**.
 2. Press **System, Reference, 10 MHz Out** to select **ON** to provide a 10 MHz frequency reference to the UUT. Verify that the UUT is accepting the external reference (Ext Ref).
 3. Press **System, Config I/O, IP Address**, enter the PSA IP address (for example, **192.168.100.3**), and then press **Subnet Mask** to set the PSA subnet mask (for example, **255.255.0.0**).
 4. Press the **System, More, Power Meter, Power Meter Config** keys.
 5. Press **Conn Mode** to select **LAN** connection mode.
 6. Press the **Power Meter IP Address** key. Enter the IP address, like **192.168.100.2**. Make sure the PSA and the power meter are using appropriate IP addresses (like the ones shown here) to communicate.
 7. Cycle power on the PSA (set the power switch to OFF then to ON). Wait until the PSA finishes the auto Cal routine.
 8. On the power meter, press **System, Remote Interfaces**, and **Restart Network** so it will recognize the new IP address that you set.
 9. Press **System, More, Power Meter, Power Meter Config**, then **Verify Power Meter Connection**. The grayed-out **Show Setup** key is enabled

when the connection between the PSA and the power meter is established.

10. Select the power meter channel number you are using by toggling the **Channel** key. If the power meter has only one channel, this key is grayed-out.
11. Press the **Show Setup** key to display and verify the power meter config information.
12. You can set the desired time-out for your testing by pressing **Power Meter Config, More, Time Out** keys.
13. Press **Power Meter Config, More, Resolution** to select the resolution as 0.001dB or 0.01 dB.

Verifying the System Connections

Upon completion of the hardware setup and system configuration, you can verify the system is prepared for calibration and making measurements.

CAUTION

Before connecting a signal to the PSA, make sure the PSA can safely accept the signal level provided. The signal level limits are marked next to the connectors on the front panel.

The signal level measured by the PSA is not going to be the same level applied to the input of the sensor module (N5532A); there is about a 6 dB loss through the sensor module.

- Step 1.** Make sure you have applied power to the UUT. Wait until the equipment warm-up complete.
- Step 2.** Adjust the UUT to output an RF signal, like 1.25 GHz at 0 dBm.
- Step 3.** Press **MODE** and select **Measuring Receiver**.
- Step 4.** Press **Preset**, then the PSA will automatically make a Frequency Counter measurement as shown.

Figure 2-4 Measuring Receiver Default Measurement (Frequency Counter)

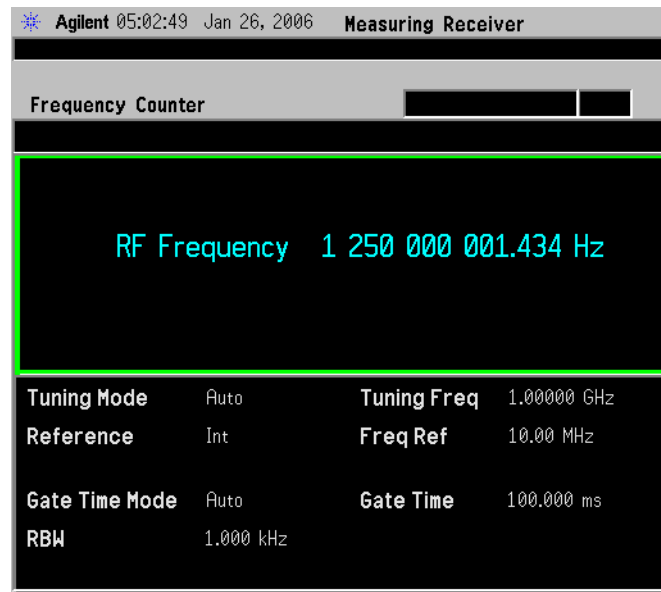

Calibrating System Components

Make sure you have connected, configured and verified the measurement system.

NOTE

RF Power and Absolute Tuned RF Level measurements require Power Meter calibration with the Sensor Module. Calibration with each Sensor Module can ensure the specified measurement accuracy.

Load Cal Factors

- Step 1.** Insert the floppy disk containing the Cal Factors of your sensor to the PSA floppy disk drive.
- Step 2.** Press **MODE** and select **Measuring Receiver**.
- Step 3.** Press **File, Load, Type, Calibration Factor** as the file type.
- Step 4.** Press **File, Load, Type, Dir Select** and select the A drive and use **Up Arrow** and **Down Arrow** to select the file name for your Sensor Module, then press **Load Now** and the file will be loaded into the PSA.

You can edit the Cal Factors by pressing **System, More, More, Power Sensor Config** to enter the config menu, then:

- press **Cal Factors, Edit Cal Factors** and use **Up Arrow** and **Down Arrow** to highlight the data point you want to change to input your edits. See [“Edit Cal Factors” on page 49](#).
- press **Cal Factors, Delete All Points** to delete all the Cal Factors;
- press **More, Clear Power Sensor** to remove all Power Sensor information loaded in the PSA; But you will have to restore the data by hand or as described in Step 2 and 3 above;
- press **Update Power-On Default** to save the current Sensor and Cal Factors information in the PSA and will be loaded next time the PSA is powered on.
- press **Recall Power-On Default** to load the Cal Factors file saved in the PSA, as a result of previously pressing **Update Power-On Default**.

This feature is used if you incorrectly edited the Cal Factors or deleted all the Cal Factors by mistake, and you need to restore the Cal Factors.

Edit Cal Factors

Step 1. Press **MODE, Measuring Receiver**.

Step 2. Press **System, More, More, Power Sensor Config** to enter the config menu.

Step 3. Press **Cal Factors, Edit Cal Factors** to enter the editor.

- To create a new data point, press **Point**, input a sequence number and press **Enter**; press **Frequency**, input a frequency and press **Enter**; press **Cal Factor**, input a factor and press **Enter**. A new Cal Factor data is created and displays on the editor window. The maximum number of Cal Factors you can input is 4095.
- To delete a data point, **Up Arrow** and **Down Arrow** to highlight the data point and press **Delete Point** to delete it;

Once you complete the edits, press **Update Power-On Default** to save the current information in the PSA and will be loaded by default next time the PSA is powered on;

Step 4. To delete all data points, press **Cal Factors, Delete All Points**.

Step 5. To save your edits in a new file, press **File, Save, Type, More, Calibration Factor, Save Now**. The file is saved in the PSA memory. The file name is determined by the PSA.

Zero and Calibrate the Power Meter

Make sure you have loaded the Cal Factors.

Step 1. Disconnect the Sensor Module from the UUT.

Step 2. Press **MODE, Measuring Receiver**.

Step 3. Press **System, Power Meter, Zero Power Meter**. When the yellow indicator of `Zero Power Meter...` disappears, the zeroing process is completed.

The zeroing process cancels any inherent DC offset that may be present within the power sensor under zero power condition.

Step 4. Connect the Sensor Module to the Power Meter REF 50 MHz port.

Step 5. Press **Calibrate Power Meter** to calibrate with the Cal Factors. When the yellow indicator of `Calibrate Power Meter...` disappears the calibration is done.

Step 6. Disconnect the Sensor Module from the Power Meter REF port, connect the Sensor Module to the UUT RF OUTPUT. Make sure the SA cable and Power Meter cable of the Sensor Module are connected to the PSA RF INPUT and the Power Meter's CHANNEL IN, respectively.

You can also press the **Zero&Cal Power Meter** key to make the calibration at one step (by connecting the Sensor to the Power Meter 50 MHz port).

NOTE

If the Power Meter is moved, if several hours have elapsed since the last calibration, or if the temperature has changed since the last calibration, you may need to repeat the Power Meter Calibration. See *Power Meter Guide*.

File Operations

This section describes file operation features for the Measuring Receiver.

File Operations for Power Sensor Calibration Factors

- To import the power sensor calibration factors and related information from the .XML file on the floppy disk shipped with the power sensor.

See [“Load Cal Factors” on page 48](#).

- To export the current power sensor calibration factors to a .XML file on a floppy disk, so that the factors can be transferred to another PSA together with the power sensor. This might take 5 to 10 minutes.

1. Press **File, Save, Type, Calibration Factor**. Press **Name**, then enter the file name you want to export. The best practice is to use the serial number of the sensor module as the name.

2. Press **Save Now**.

3. Press **File, Catalog Dir Select**. Highlight C and press **Dir Select**.

4. Press **Type, Calibration Factor**.

5. Press **Return, Copy, Dir To, Dir Select**. Highlight A and press **Dir Select**.

6. Press **Dir From, Dir Select**. Highlight C and press **Dir Select**.

7. Highlight CF Data.xml file. Press **Copy Now**.

- To save the power sensor calibration factors to the Flash memory of PSA, once the Load Cal Factor process is complete.

Press **System, More, More, Power Sensor Config, More, Update Power-On Default** to save the current Sensor and Cal Factors information in the PSA and will be loaded next time the PSA is powered on.

- To recall the power sensor calibration factors from the Flash memory of PSA.

Press **System, More, More, Power Sensor Config, Cal Factors, More, Recall Power-On Default** to load the Cal Factors file saved in the PSA.

The format of the .XML File is shown in the following example:

```

<Calibration>
<ModelNumber>N5532A</ModelNumber>
<Options>518</Options>
<SerialNumber>US44330015</SerialNumber>
<DateCalibrated>20000101</DateCalibrated>
<ReferenceCF>98</ReferenceCF>
<CalFactor>
<Frequency Unit= "Mhz">10</Frequency>
<CalFactor Unit= "Percent">99.2135310306974</CalFactor>
</CalFactor>
<CalFactor>
<Frequency Unit= "Mhz">30</Frequency>
<CalFactor Unit= "Percent">98.7875312060724</CalFactor>
</CalFactor>
</Calibration>
  
```

Most of the SCPI commands for the calibration factors file operations are consistent with those in the MMEMory subsystem, for example, Catalog, Delete, etc., except for Save and Load.

File Operations for Tuned RF Level Calibration Factors

TRFL measurements can support store and recall functions for the convenience of repetitive TRFL measurements at many different frequencies. Because the cal factors are dependent on the instrument setting and TRFL measurement setting, cal factors are saved into the **ISTATE** file with instrument and measurement settings. When you recall the cal factors, not only the cal factors are recalled, but all of the instrument and measurement settings are recalled.

When to Recalibrate

- When you change the current sensor to a different type (for example, from N5532A Option 504 to N5532A Option 518), and RF Power measurement is selected, the Measuring Receiver displays the RECAL annunciator.
- When you change the current sensor to a same type, but a different one (for example, from N5532A Option 504 to another N5532A Option 504), and RF Power measurement is selected, the Measuring Receiver DOES NOT recognize the need for recalibration although a recalibration should be performed.
- If you are in doubt about whether the calibration factors match the power sensor, you should recalibrate.

PSA Range Calibration

Only the Tuned RF Level measurements require the PSA range calibration.

As the signal level into the PSA is decreased, the signal to noise ratio changes not only because the signal is closer to the noise but because some of the internal settings of the PSA change to optimize the measurement. The measuring routine in the PSA calculates the approximate power level a range calibration is needed based on S/N. When the signal level at the PSA reaches this range calibration power, the calibration routine makes measurements in both the current range and the next range. A Cal Factor value is generated and is used to correct the measurement.

There are two range calibrations; Range 1 to Range 2 and Range 2 to Range 3.

The range calibration procedure can be a separate process that you perform before you begin the TRFL measurement on your UUT (the process outlined here), or the range calibration can be performed during the TRFL measurement of the UUT.

The range calibration can be triggered automatically by the PSA, or it can be triggered manually. Press **Meas Setup, Range Switching**, to select **Auto** or **Man**. Auto mode will probably be used most of the time. In Man mode, a Recal message appears on screen alerting the user a range calibration is required. The range calibration will be held off until you press **TRFL Calibrate**. There may be situations slightly above the calculated range switch point where you want to continue making measurements in the current range.

NOTE

The range calibration “assumes” the power level of the current range is close to the range switch point. Example: if the PSA calculates the range 2 to range 3 switch point at – 80 dBm, the range calibration must be done within a few dB of – 80 dBm. Therefore, it is important to step the power level down in steps of 10 dB or less to allow optimum calibration.

For optimum accuracy, a Range 3 Switch Delay can be enabled. If you use this switch delay, you must have it turned on for both the range calibration and the measurement.

If you chose to allow the range calibration to occur as part of the TRFL measurement of the UUT, the UUT measurement will be interrupted while the calibration takes place.

Measurement Procedure Using a N5532A Sensor Module

- Step 1.** Connect, configure, and verify the measurement system. See [“System Hardware Connections” on page 40](#) and [“System Configuration” on page 43](#).

- Step 2.** Calibrate the power meter. See “Zero and Calibrate the Power Meter” on page 49.
- Step 3.** Connect the sensor module to the signal source and assure proper connector care and connector torque settings are followed. SMA/ 3.5mm connectors should receive 8 inch-pounds of torque and Type N connectors 12 in-pounds.
- Step 4.** On the PSA, perform the Auto Align routine by pressing **System, Alignments, Align All Now**.
- Step 5.** Set the signal source amplitude and frequency. For this example use 0 dBm and 50 MHz. Do not change any settings during this procedure.
- Step 6.** Configure the PSA settings as follows:

Table 2-6 **PSA Settings**

Parameter	Setting
Mode	Measuring Receiver
Measure	Tuned RF Level
Frequency <i>Note: Do not use the Frequency Counter function. You must press the Frequency key and set the frequency manually.</i>	Same as signal source frequency
Range 3 Switch Delay <i>(Under Meas Setup, More)</i>	See note below May choose On or Off. Default is Off
Range Switching	Default is Auto
10 MHz Out <i>(Under System, Reference)</i>	ON
Freq Ref <i>(Under System, Reference)</i>	Int

NOTE

Range 3 Switch Delay

When range 3 is entered, several internal PSA settings are changed including enabling the optional preamp and decreasing input attenuation. For optimum accuracy, a delay of five minutes is initiated when this function is ON. The delay allows the preamplifier to stabilize. Assure the Range 3 Switch Delay is On for both the Range Calibration and the TRFL measurement process since you may perform the Range Calibration as a separate routine.

Step 7. Press **Restart**

NOTE

Pressing **Restart** optimizes the measuring receiver configuration, and is very important when changes to the measuring receiver settings or the UUT are made. Pressing **Restart** causes the measuring receiver to determine if the PSA settings are correct for the incoming signal, and if they are not, slight changes are made.

Observe the red Range 1 status indicator displayed on the PSA screen and the Cal Factor 1 value. When using the Power Meter, the cal factor for range 1 is established during the first measurement. Also notice that the Range 2 and Range 3 Switch levels are displayed. See [Figure 2-5](#).

Figure 2-5 Automatic Range Calibration

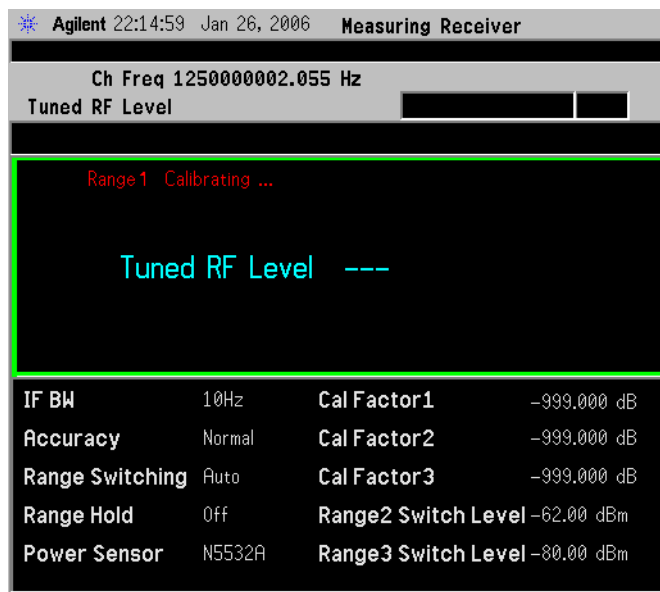

Step 8. Decrease the power level of the source in 10 dB increments. When the “Calibrating Range 1” and then the “Calibrating Range 2” indicator is displayed, the PSA is automatically performing the range calibration. When the calibration is complete, the calibrating message disappears and the Cal Factor Range 2 value is displayed.

If Range Switching is set to Man, the Recal status indicator is displayed when the range calibration point is reached. Press **Meas Setup**, **TRFL Calibrate** to trigger the calibration. See [Figure 2-6](#).

Figure 2-6

Manual Range Calibration

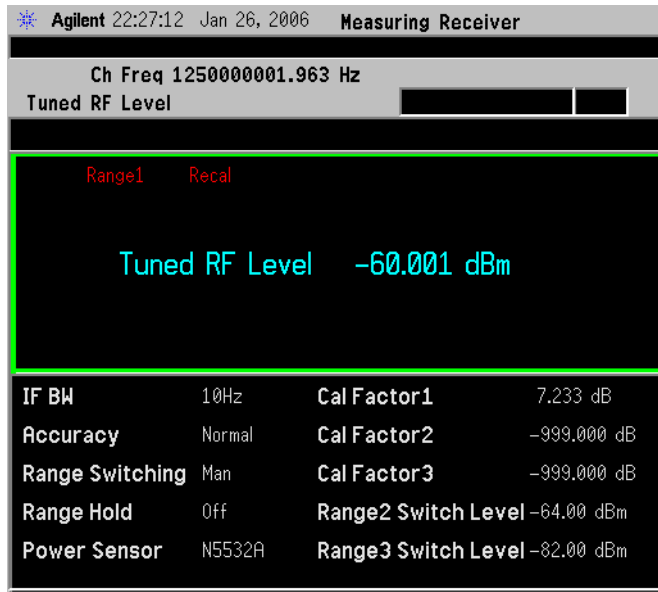

Step 9. Continue to decrease the power level of the source in 10 dB increments. When the “Calibrating Range 2” and then the “Calibrating Range 3” indicator is displayed, the PSA is automatically performing the range calibration. When the calibration is complete, the calibrating message disappears and the Cal Factor Range 3 value is displayed. If Range 3 Switch delay is On, the calibration will take about 5 minutes. See [Figure 2-7](#).

If Range Switching is set to Man, the Recal status indicator is displayed when the range calibration point is reached. Press **Meas Setup**, **TRFL Calibrate** to trigger the calibration.

Figure 2-7 Range Calibration Completes

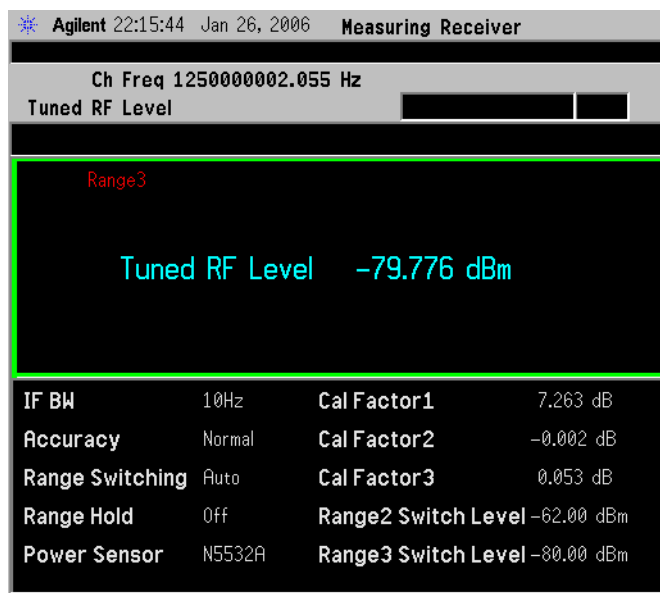

Protecting Against Electrostatic Discharge

Electrostatic discharge (ESD) can damage or destroy electronic components (the possibility of unseen damage caused by ESD is present whenever components are transported, stored, or used).

Test Equipment and ESD

To help reduce ESD damage that can occur while using test equipment:

- Before connecting any coaxial cable to an analyzer connector for the first time each day, momentarily short the center and outer conductors of the cable together.
- Personnel should be grounded with a 1 M Ω resistor-isolated wrist-strap before touching the center pin of any connector and before removing any assembly from the analyzer.
- Be sure that all instruments are properly earth-grounded to prevent build-up of static charge.

WARNING

Do not use the first three techniques listed above when working on circuitry with a voltage potential greater than 500 volts.

- Perform work on all components or assemblies at a static-safe workstation.
- Keep static-generating materials at least one meter away from all components.
- Store or transport components in static-shielding containers.
- Always handle printed circuit board assemblies by the edges. This reduces the possibility of ESD damage to components and prevent contamination of exposed plating.

Additional Information about ESD

For more information about ESD and how to prevent ESD damage, contact the Electrostatic Discharge Association (<http://www.esda.org>). The ESD standards developed by this agency are sanctioned by the American National Standards Institute (ANSI).

3 Making Measurements

This chapter describes procedures used for making measurements using the N5531S Measuring Receiver System. Instructions to help you set up and perform the measurements are provided, and various measurement examples are shown.

Measuring Receiver Measurements

The N5531S Measuring Receiver System is designed to make extremely accurate measurements on RF/Audio signals. There are thirteen individual measurements available.

Individual measurements are made either by using default settings, or user adjusted settings for better measurement control. All measurements are referred to as one-button measurements. After selecting and pressing the measurement button, it becomes active.

Go to the following sections to learn about how to set up and make measurements and which measurements are available in the N5531S system:

- [“Frequency Counter Measurement” on page 65](#)
- [“RF Power Measurement” on page 69](#)
- [“Tuned RF Level Measurement” on page 73](#)
- [“AM Depth Measurement” on page 81](#)
- [“FM Deviation Measurement” on page 86](#)
- [“PM Deviation Measurement” on page 91](#)
- [“Modulation Rate Measurement” on page 96](#)
- [“Modulation Distortion Measurement” on page 101](#)
- [“Modulation SINAD Measurement” on page 105](#)
- [“Audio Frequency Measurement” on page 109](#)
- [“Audio AC Level Measurement” on page 112](#)
- [“Audio Distortion Measurement” on page 114](#)
- [“Audio SINAD Measurement” on page 116](#)

Instrument Front Panel Highlights

The most commonly used function keys on the PSA front panel are located as shown in the illustrations below. The operation of the keys is briefly explained on the following page. Refer to your User's Guide for complete details on all keys.

Figure 3-1 Selected PSA Series Front Panel Feature Locations

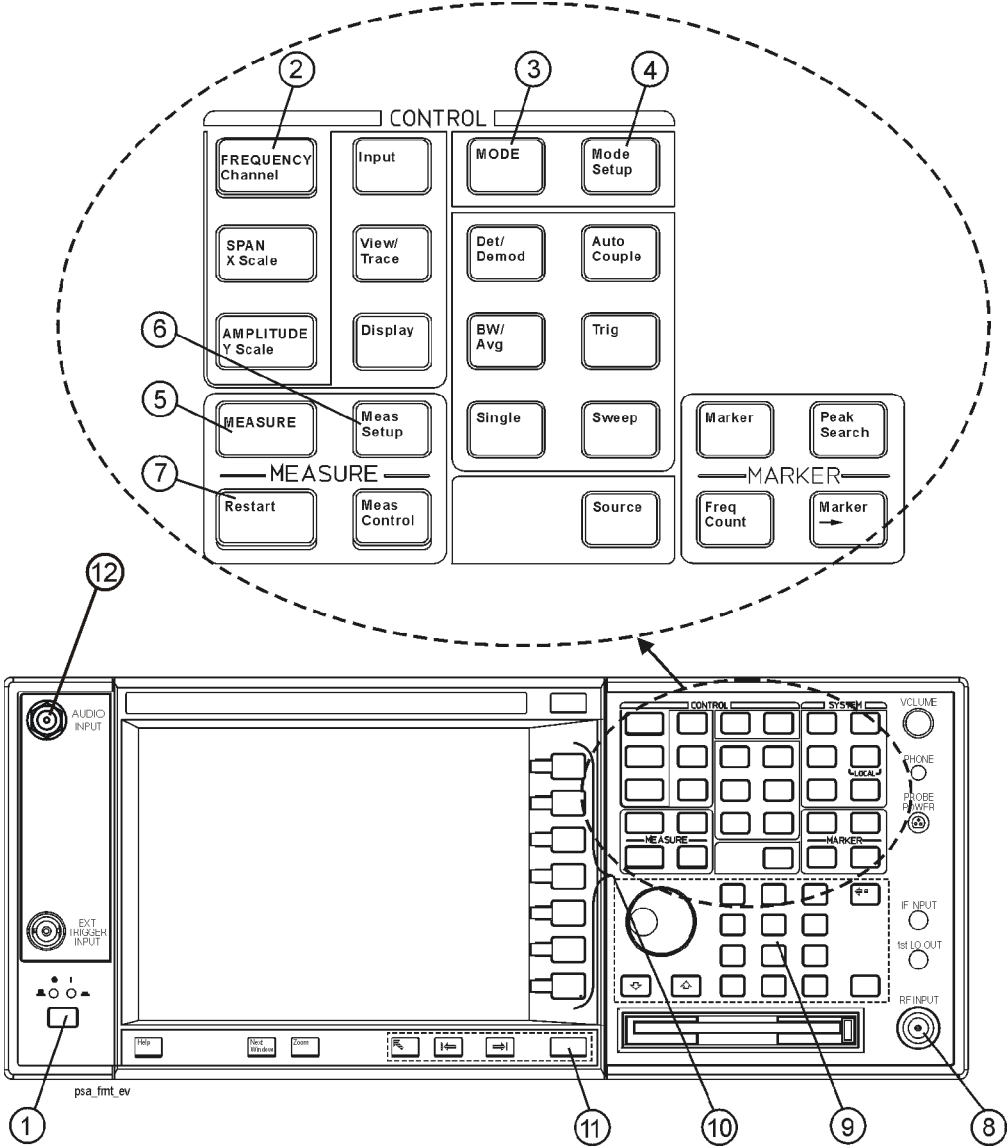

Selected PSA Front-Panel Features

1. The **On/Off** switch toggles the AC Line power between On and Standby. A green LED will light when the instrument is On. When energized in the standby mode, a yellow LED is lit above the switch.
2. **FREQUENCY Channel** accesses a key menu to set the analyzer center frequency in units of Hz, kHz, MHz, or GHz, or by channel number. These parameters apply to all measurements in the current mode.
3. **MODE** accesses a key menu to select one of the measurement personalities installed in the instrument. Each mode is independent from all other modes.
4. **Mode Setup** accesses a key menu that sets parameters specific to the current mode and can affect all measurements within that mode.
5. **MEASURE** accesses a display key menu to initiate one of the various measurements that are specific to the current mode.
6. **Meas Setup** accesses the menus of test parameters that are specific to the current measurement.
7. **Restart** causes a measurement to start again from the initial process according to the current measurement setup parameters.
8. **RF INPUT** port: Type N connector for the E4443A, E4445A, and E4440A PSAs. 2.4mm on the E4446A and E4448A PSAs. 3.5mm connector on all E4440As with Opt BAB. The maximum input power level is shown next to the port.
9. The **Data Entry** keypad is used to enter numeric values. Keypad entries are displayed in the active function area of the screen and become valid for the current measurement upon pressing the **Enter** key or selecting a unit of measurement, depending on the parameter.
10. The Display Menu keys allow you either to activate a feature or to access a more detailed sub-menu. An arrow on the right side of a softkey label indicates that the key has a further selection menu. The active menu key is highlighted, however, grayed-out keys are currently unavailable for use or only show information. If a menu has multiple pages, successive pages are accessed by pressing the **More** key located at the bottom of the menu.
11. Pressing the **Return** key allows you to exit the current menu and display the previous menu. Often, pressing a menu key will invoke a multi-page sub-menu. Pressing the **Return** key will show the menu “above” it, not a previous page. When you activate another measurement, the return list is cleared. The **Return** key will not return you to a previously activated mode, nor will it alter any values you have entered in previous menus.
12. **BNC Audio Input** (PSA Option 233 Measuring Receiver only)
Provides a 100 kOhm input for audio measurements. Frequency

range is 20 Hz to 250 kHz. Safe input level is 7 Vrms or 20 V DC.

Mode Setup

All measurements need to be set up in 3 steps: first at the Mode level, second at the Measurement level, then finally the result display may be adjusted.

Press **MODE**, then all licensed, installed Modes available are show. Press **Measuring Receiver** to select Measuring Receiver mode.

Press **Input/Output** to adjust the input port and attenuation. You can change the external audio attenuation by pressing **Ext Aud Atten** and entering the appropriate value and unit. To change the audio input ranging, press **Audio Ranging** and select a range according to your input.

Press **Det/Demod** key to adjust detectors, filters.

Press **MEASURE** to select a specific measurement to be performed. Press **Frequency Counter** or **Preset** to get the RF frequency before making other measurements.

Press **Meas Setup** to make any adjustments as required to the selected measurement settings. The settings only apply to this measurement.

Press **Trace/View** to select a display format for the current measurement data. Depending on the mode and measurement selected, some graphical and tabular data presentations may be not available and **X-Scale** or **Y-Scale** may be grayed out.

NOTE A setting may be reset at any time, and will be in effect on the next measurement cycle or View.

Step	Primary Key	Setup Keys	Related Keys
1. Select & set up a Mode	MODE	Mode Setup, Input/Output, Det/Demod, FREQUENCY Channel	System
2. Select & set up a Measurement	MEASURE	Meas Setup	Meas Control, Restart
3. Select & set up a View of the Results	Trace/View	SPAN X Scale, AMPLITUDE Y Scale, Next Window, Zoom	File, Save

CAUTION If you make changes to the UUT or measuring receiver settings after you make your first measurement, press the **Restart** key to optimize the measuring receiver configuration.

Frequency Counter Measurement

The Frequency Counter measurement is used to determine the center frequency of an unmodulated RF carrier, or of a CW audio signal. It is the default measurement of the personality, and its result is used in many subsequent measurements. Therefore, connection setup and execution of this measurement is important to assure good results for follow-on measurements.

This procedure describes how to make a Frequency Counter measurement. In this measurement example, a signal generator is the UUT and is adjusted to deliver a test signal. The Frequency Counter measurement is used to measure and display the frequency of the signal.

If the nominal frequency of the signal under test is known, the Measuring Receiver can be manually tuned to that frequency to make the Frequency Counter measurements. Manual tuning is particularly useful if the signal level is so low that automatic tuning may have difficulty finding the signal. Manual tuning also allows faster measurements when the frequency of the input signal is much higher than 100 MHz.

CAUTION

To make the Frequency Counter measurement, make sure you have turned off the signal modulation. After measuring the carrier frequency, turn on the signal modulation and continue making other modulation measurements.

NOTE

You can make Frequency Counter measurements without a Power Meter since it is the PSA that measures the RF Frequency.

Measurement Procedure

CAUTION Press the Restart key to optimize the measuring receiver configuration if you make any changes to the UUT or to the measuring receiver settings after you make your first measurement.

Step 1. Setup the measurement system. See “[System Hardware Connections](#)” on page 40.

To measure the RF frequency, you do not need to perform the Power Meter calibration.

Step 2. Make sure you have selected **Measuring Receiver** mode in the **MODE** key menu.

Step 3. Adjust the signal generator to the required settings for your test.

Step 4. Press **Frequency Counter** key to perform the measurement. Or, press **Preset** key. The default measurement is Frequency Counter with display units in Hz.

Step 5. When the measurement is completed, the measurement result will display.

NOTE The PSA can only search for a signal within a maximum center frequency offset:
Maximum Searchable Offset = $(106 * \text{RBW})$ or $(0.001\% \text{ of Tuned Frequency})$.

Step 6. You can adjust measurement settings by pressing **Meas Setup**, then:

1. To change the tuning mode from **Auto** to **Man**, press the **Tuning** key and enter the expected frequency value and unit. The default tuning mode is **Auto**.

Using Manual Tuning mode in the following cases:

- a. The SigLo warning indicator on screen when you decrease the signal level. Selecting Man tuning mode and entering the expected frequency may allow a measurement to be made.
- b. You need to measure the Frequency Error. The Frequency Error is the difference between the measured frequency and the nominal input value.
- c. You need to increase the measurement speed by using a known signal. When the signal frequency under test is above 100 MHz, the **Auto** mode testing is slower than the **Man** mode.

NOTE You may connect the PSA and the UUT to a common high standard time base. Make sure the time base lock is not used for Frequency Counter measurements.

2. To change the gate time from **Auto** to **Man**, toggle the **Gate Time** key to **Man** and enter the time value and unit. The default gate time mode is **Auto**. The default setting is **100 ms**. When you need a more stable readout, select a longer gating time, but it will take longer to get the measurement results. If the gating time is 2 ms or longer, the resolution is 0.001 Hz.
3. To change the average setting between **On** and **Off**, press the **Avg Number** key. When setting to **On**, enter the number. The default average setting is **Off** and the default number is 25 when switching to **On**. When the input signal is changed during the average period, wait until the averaging is done or the next averaging period starts.
4. To change the average mode, toggle the **Avg Mode** key between **Exp** and **Repeat**. The default average mode is **Repeat**.
5. To change the RBW, press the **RBW** key and enter the bandwidth value and unit. The default setting is **1 kHz**.

Step 7. You can adjust the display by pressing **AMPLITUDE/Y Scale**, then:

1. Press the **Display Unit** key and select a display unit key, like **MHz**. The default setting is **Hz**.
2. Press the **Display Mode** key to toggle between **Normal** and **Ratio**. The default setting is **Normal**.
3. Press the **Ratio Ref** key to toggle between **Auto** and **Man**. When you select **Man**, input the reference frequency value and unit. When the reference is set to 0 or the measurement result is 0 under log ratio mode, the result displayed is “- - -”.
4. Press the **Ratio Mode** key to toggle between **Log** and **Linear**.

NOTE

For Model E4440A, E4443A and E4445A, the PSA is set from DC coupling to AC coupling when searching signals above 100 MHz using Auto tuning. If no signal is found with full span search, press **Preset** to reset to DC coupling for a new search under 100 MHz.

For Model E4446A, E4447A and E4448A, the PSA is always set to DC coupling.

Frequency Counter Measurement Example

Figure 3-2

Frequency Counter Measurement Result (Default)

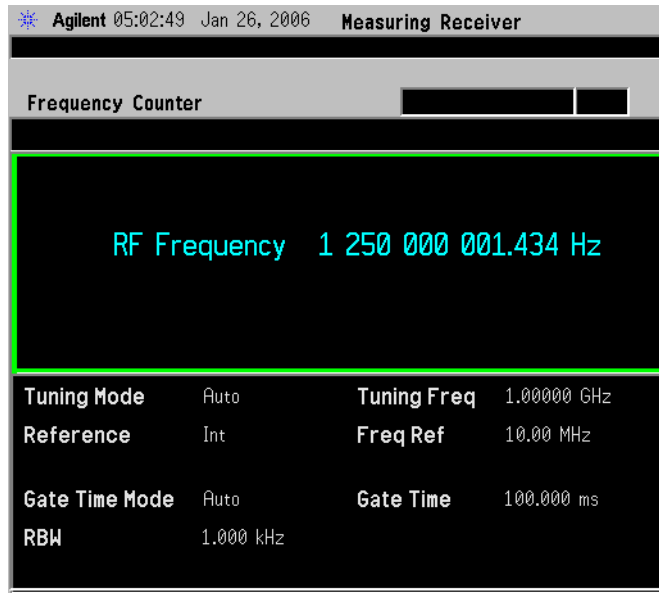

Signal Under Test:

RF Frequency: 1.25 GHz; Amplitude: 0.0 dBm; Modulation: Off

In this example, the measured RF Frequency is 1250000001.434 Hz

NOTE

When you want to see the frequency difference, it's recommended to use the manual tuning with RF Frequency Error display, rather than use the Ratio Mode.

Figure 3-3

Frequency Error Result

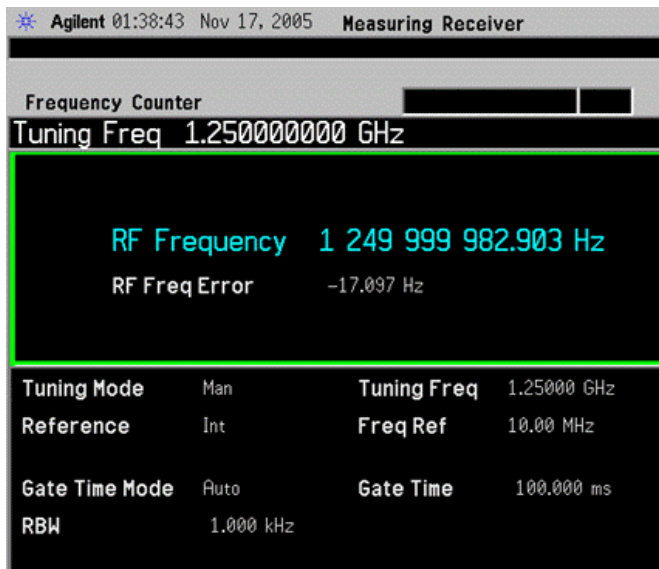

RF Power Measurement

This procedure describes how to make a RF Power measurement. In this measurement example, a signal generator is the UUT and is adjusted to deliver a test signal. The RF Power Measurement measures and display the power of the signal.

RF Power quantifies the output level, in an absolute term, of a signal generator or an attenuator being calibrated. This is a common measure for broadband RF/microwave signal qualification.

NOTE

The measurement default is to use a Power Meter with a Sensor Module to make the RF Power measurement. The Power Meter measures the RF Power and returns the result to the PSA.

Alternatively, you can measure the RF Power with only the PSA. Press **Meas Setup, Use Power Meter, No**. To determine the accuracy when measuring the RF signal level with the PSA, refer to the PSA *Specification Guide*.

Measurement Procedure

NOTE

For AM/FM/PM modulated signals, the modulation may distort the original signal spectrum and the instrument may not determine the correct carrier frequency.

Since the result of this measurement is used to calculate follow-on measurements, the alternative is to input the carrier frequency manually by pressing **Frequency Channel** key. This avoid the need to make Frequency Counter measurement before other measurements.

CAUTION

Press the Restart key to optimize the measuring receiver configuration if you make any changes to the UUT or to the measuring receiver settings after you make your first measurement.

Using a P-Series Power Meter with a N5532A Sensor Module

- Step 1.** Connect, configure and verify the measurement system. See [“System Hardware Connections” on page 40](#), [“System Configuration” on page 43](#) and [“Verifying the System Connections” on page 47](#).
- Step 2.** Calibrate the Power Meter see [“Calibrating System Components” on page 48](#). Also see [“Load Cal Factors” on page 48](#) and [“Edit Cal Factors” on page 49](#).
- Step 3.** Make sure you have selected **Measuring Receiver** mode in the **MODE** key menu.

Making Measurements
RF Power Measurement

Step 4. Adjust the signal to the desired settings for your test.

Step 5. Perform a Frequency Counter measurement to accurately determine the center frequency of your signal. When the frequency readout is displayed, the PSA is automatically tuned to the input frequency.

Step 6. Press the **RF Power** key.

Wait for the measurement to be completed and the measurement result to be displayed.

Step 7. To adjust the measurement settings, press the **Meas Setup** key, then:

1. press the **Use Power Meter** key to toggle the Power Meter presence between **Yes** and **No** to indicate whether your system includes a Power Meter. The default setting is **Yes**.
2. press the **Avg Number** key to toggle averaging between **On** and **Off**. When setting to **On**, enter the number. The default average setting is **Off** and the default number is 4 when averaging is **On**. If the input signal changes during the average period, wait until the averaging is done or the next averaging period starts.
3. press the **Avg Mode** key to toggle the average mode between **Exp** and **Repeat**. The default average mode is **Repeat**. In the Repeat mode, the averaging is reset and a new average is started after the average count is reached. By contrast, in the Exponential mode, each successive data acquisition after the average count is reached, is exponentially weighted and combined with the existing average.

Step 8. To adjust the Power Meter resolution, press **System, More 1 of 3, More 2 of 3, Power Meter, Power Meter Config, More 1 of 2**, then toggle the **Resolution** key between **0.01 dB** and **0.001 dB**.

To adjust the time-out time for connecting the Power Meter, press **System, More 1 of 3, More 2 of 3, Power Meter, Power Meter Config, More 1 of 2, Time Out**, enter the time value and select the unit.

Step 9. To adjust the display settings, press **AMPLITUDE/Y Scale**, then:

1. press the **Display Unit** key and select a display unit key, like **Watt, V, dBm**. The default setting is **dBm**.
2. press the **Display Mode** key to toggle between **Normal** and **Ratio**. The default setting is **Normal**.
3. press the **Ratio Ref** key to toggle between **Auto** and **Man**. When you select **Man**, input the reference value and unit. When the input signal is too low, no measurement results display and you get SigLo indicator.
4. press the **Ratio Mode** key to toggle the display reading between **Log** (logarithmic, unit **dB**) and **Linear** (linear, unit **%**).

Troubleshooting Hints

You may have following red status indicator in the measurement result window, or error messages on the bottom of the screen:

- **PMError** -- No Power Meter connected or you need to perform the Power Meter Calibration. If the power meter is not used to make the measurement, press **Meas Setup, Use Power Meter, NO**. This will disable the error message.

For more error information, press **System, Show Errors**.

Table 3-1 Status Bar Messages

Message	Meaning	Type
Connecting to Power Meter is failed	Can't open a connection between the PSA and Power meter.	Error
Connecting to Power Meter is timed out	When sending a SCPI command to external Power, no value return in the specified time	Error
No cal factors for the power sensor available	The power calibration factors file for the power sensor is not loaded or inputted, so the measurement will use 100% as the default for all frequency points.	Warning
Please zero and cal the power meter	Please zero and cal the power meter before measuring	Error
Please zero the power meter	Please zero the power meter before measuring	Error
Please cal the power meter	Please cal the power meter before measuring	Error
Zeroing the power meter is failed	Zeroing the power meter is failed	Error
Calibrating the power meter is failed	Calibrating the power is failed	Error
Power Meter model is not supported	The power meter model is not supported	Error
Power Sensor hardware is missing	Power Sensor hardware is missing	Error
RF Frequency exceeds the Cal Table	The measured RF frequency exceeds the Cal Table	Warning

RF Power Measurement Example

Figure 3-4

RF Power Measurement Result (Default)

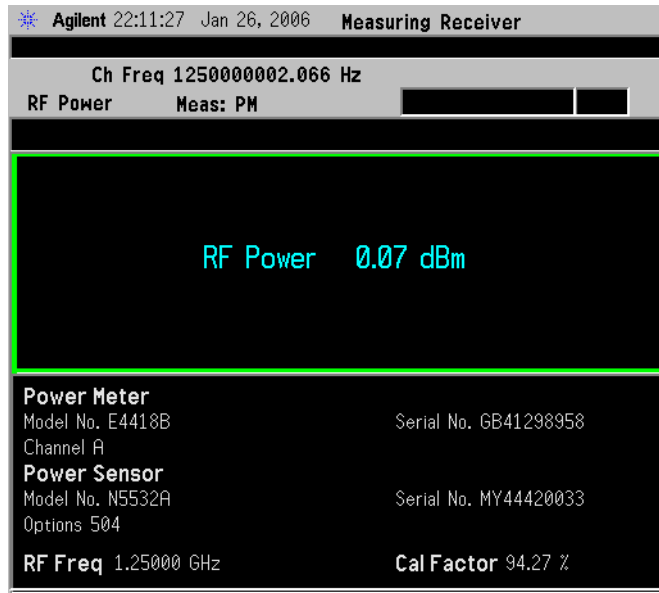
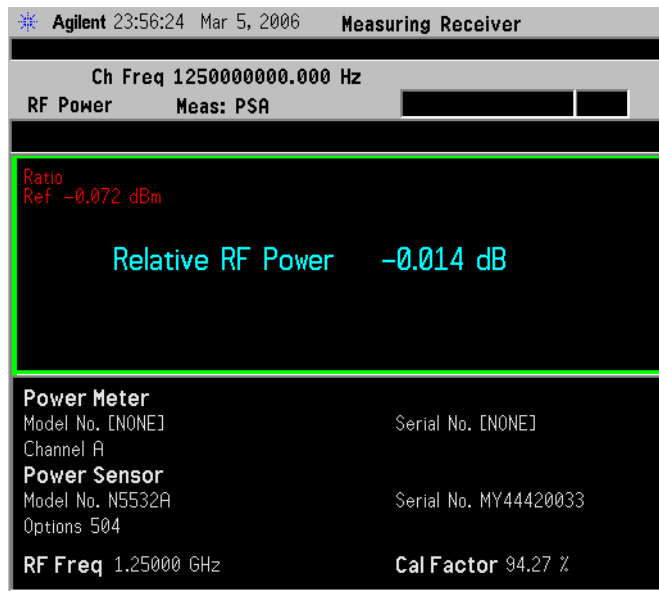

Figure 3-5

RF Power Measurement Result (Ratio Display Mode)



Signal Under Test:

RF Frequency: 1.25 GHz; Amplitude: 0.0 dBm; Modulation: Off;

In this example, the measured RF Power is 0.07 dBm and the measured Relative RF Power is 0.014 dB.

Tuned RF Level Measurement

This procedure describes how to make a Tuned RF Level measurement. In this measurement example, a signal generator is the UUT and is adjusted to deliver a test signal. Tuned RF Level measurement is used to measure that signal. The source power is stepped down and the PSA displays the Tuned RF Level of the signal.

Unlike RF Power measurements, which measure total power across a wide frequency band, the Tuned RF Level measurement requires the PSA to be tuned to the frequency of interest and is capable of measuring low power levels. This is particularly useful when a step attenuator or a signal generator is tested for its step accuracy of power output with incremental changes.

NOTE You need a Power Meter with a Sensor Module to make an “absolute” Tuned RF Level measurement. The Power Meter provides the initial absolute power reference for the PSA.

Alternatively, you can make a relative Tuned RF Level measurement without a Power Meter.

Measurement Procedure

NOTE When making a relative Tuned RF Level measurement, optimal measurement accuracy and speed is obtained by setting the frequency on the PSA directly using the **FREQUENCY Channel** key (do not use the frequency counter).

CAUTION Press the Restart key to optimize the measuring receiver configuration if you make any changes to the UUT or to the measuring receiver settings after you make your first measurement.

Using a Power Meter with a N5532A Sensor Module (Absolute TRFL Measurement)

- Step 1.** Connect, configure and verify the measurement system. See [“System Hardware Connections” on page 40](#) and [“System Configuration” on page 43](#).
- Step 2.** Calibrate the Power Meter see [“Zero and Calibrate the Power Meter” on page 49](#).
- Step 3.** Connect the sensor module to the signal source and assure proper connector care and connector torque settings are followed. SMA/3.5 mm connectors should receive 8 inch-pounds of torque and Type N connectors 12 in-pounds.

Making Measurements
Tuned RF Level Measurement

- Step 4.** On the PSA, perform the Auto Align routine by pressing **System, Alignments, Align All Now**.
- Step 5.** Set the signal source amplitude and frequency. For this example use 0 dBm and 50 MHz.
- Step 6.** Configure the PSA settings as follows:

Table 3-2 **PSA Settings**

Parameter	Setting
Mode	Measuring Receiver
Measure	Tuned RF Level
Frequency <i>Note: Do not use the Frequency Counter function. You must press the Frequency key and set the frequency manually.</i>	Same as signal source frequency
Accuracy (Under Meas Setup)	High
IF BW (Under Meas Setup)	10 Hz (default)
Range 3 Switch Delay (Under Meas Setup, More)	ON
10 MHz Out (Under System, Reference)	ON
Freq Ref (Under System, Reference)	Int

Notes on the PSA Settings

Accuracy

Default is **Normal**. When Accuracy is set to **Normal**, the standard deviation for the measurement is 0.027 dB for the SNR is >30 dB, or 0.1 dB, when the SNR is <30 dB.

When the setting is **High**, the standard deviation for the measurement is 0.027 dB regardless of the SNR value.

Range 3 Switch Delay

When range 3 is used, several internal PSA settings are changed including enabling the optional preamp and decreasing input attenuation. For optimum accuracy, a delay of several minutes is initiated when this function is **ON**. The delay allows the PSA circuitry to

stabilize. Assure the **Range 3 Switch Delay** is On for both the Ranging Calibration and the TRFL measurement process since you may perform the Ranging Calibration as a separate routine. However, many users will take advantage of the fact the Ranging Calibration will be triggered automatically (if the Range Switching is set to AUTO) as part of the TRFL measurement routine. See “PSA Range Calibration” on page 52.

IF BW

Default is 10 Hz. Setting **IF BW** to 10 Hz allows you to measure lower signal levels but it cannot tolerate poor FM from the source. Setting the **IF BW** to 75 Hz offers better tolerance to residual FM, but the measurement range is reduced by 8.75 dB.

Range Switching

Default is auto mode. In **Manual** mode, you have to press the **TRFL Calibrate** key to perform a range calibration. In **Auto** mode, the **TRFL Calibrate** key is grayed out and the N5531S performs the Range Calibration automatically depending on the SNR.

Range Hold

Default is Off. When Range Hold is **OFF**, the range setting will automatically change based on the SNR.

Setting Range Hold to **ON** will force the measurement to remain in the current range the measurement is using. This may be useful for making repeatable measurements on signal levels that are exactly at the range change trip point or for unstable signals near the range change trip point.

Set Ref

Used when performing relative TRFL measurements. Upon pressing Set Ref, an amplitude reference is taken. When performing relative TRFL measurements a Range 1 Cal Factor is not obtained, but Range 2 and Range 3 cal factors are required.

- Step 7.** Press the **Restart** key and wait for the measured value to be displayed.
- Step 8.** Press **Measure Control**, select **Measure Single** and press the **Restart** key. This will allow you to control when the measurement is taken so you can assure the source is set to the proper level before beginning the measurement. You will need to press the **Restart** key each time you want to make a measurement.

NOTE

Do not Preset the PSA, or use the Frequency Counter function. If you do, the instrument will require at least 30 minutes for stabilization.

- Step 9.** Perform the following steps for each measurement value:

Making Measurements

Tuned RF Level Measurement

1. Decrease the source power level to the next lower setting and press the **Restart** key.

NOTE

Since the PSA will automatically change ranges and calibrate the ranges as needed on the first pass through a new measurement, use step sizes of 10 dB or less to obtain optimum range calibrations.

2. Record the Tuned RF Level result.
3. Continue decreasing the source level and repeating steps 1 and 2.
4. When the source level reaches a power level where the PSA requires the Range 2 change, your measurement will be interrupted and a range calibration will occur. This range calibration will only occur the first time you perform the measurement at a particular frequency and power level using the current PSA settings. The approximate range switch level is displayed on screen.

If any PSA settings such as IF BW, or if the input frequency is changed, a new range calibration will be required.

5. Continue decreasing the source level and repeating steps 1 and 2.
6. When the source level reaches a power level where the PSA requires the Range 3 change, your measurement will be interrupted and a range calibration will occur. This will take about 5 minutes since the Range 3 Switch delay is set to **ON**.

NOTE

As the power level is decreased the measurement time will increase since the signal is closer to the noise and more averaging is required. The sensor module attenuates the signal. When measuring very low level signals, consider using the relative TRFL measurement which does not require the sensor module and power meter.

7. When all source levels have been measured, calculate the TRFL measurement error. See the Measuring Receiver Personality specifications in the PSA Specification Guide. The Absolute Measurement Accuracy specification applies

NOTE

If you wish to start a new series of measurements, and want to clear the Cal Factor values, press **Measure Setup**, and toggle the IF BW to 75 Hz then back to 10 Hz. Press **Measure, Tuned RF Level** to begin a new measurement.

NOTE

If the frequency setting of the measurement is changed you must clear the Cal Factor values and recalibrate the ranges at the new frequency.

Performing a Relative TRFL Measurement Without the Power Meter

- Step 1.** Connect, configure and verify the measurement system. See “[System Hardware Connections](#)” on page 40 except do not use the N5532A Sensor module and connect the DUT output to the PSA RF Input.
- See “[System Configuration](#)” on page 43. Although you are not using the power meter for this test, you may want to set it up for future for future Power measurements.
- Step 2.** On the PSA, perform the Auto Align routine by pressing **System, Alignments, Align All Now**.
- Step 3.** Set the signal source amplitude and frequency. For this example use 0 dBm and 50 MHz.
- Step 4.** Configure the PSA settings as shown in the table above.
- Step 5.** Press the **Restart** key. Error messages will appear because the measuring receiver defaults to the absolute TRFL measurement where the power meter is required.
- Step 6.** Press **Meas Setup, Set Ref** keys. The measuring receiver is now set to perform the relative TRFL measurement where a power meter is not required. The error messages will go away, and the Tuned RF Level display should read 0.000dB.
- Step 7.** Press **Measure Control**, select **Measure Single** and press the **Restart** key. This will allow you to control when the measurement is taken so you can assure the source is set to the proper level before beginning the measurement. You will need to press the **Restart** key each time you want to make a measurement.

NOTE Do not Preset the PSA, or use the Frequency Counter function. If you do, the instrument will require at least 30 minutes for stabilization.

- Step 8.** Perform the following steps for each measurement value:
1. Decrease the source power level to the next lower setting and press the **Restart** key.

NOTE Since the PSA will automatically change ranges and calibrate the ranges as needed, use step sizes of 10 dB or less.

2. Record the Tuned RF Level result.
3. Continue decreasing the source level and repeating steps 1 and 2.
4. When the source level reaches a power level where the PSA requires the Range 2 change, your measurement will be interrupted and a range calibration will occur. This range calibration will only occur the first time you perform the measurement at a particular

Making Measurements

Tuned RF Level Measurement

frequency and power level using the current PSA settings. There will be no Cal Factor 1 value shown on the display.

If any PSA settings such as IF BW, or if the input frequency is changed, a new range calibration will be required.

5. Continue decreasing the source level and repeating steps 1 and 2.
6. When the source level reaches a power level where the PSA requires the Range 3 change, your measurement will be interrupted and a range calibration will occur. This will take about 5 minutes since the Range 3 Switch delay is set to **ON**.
7. When all source levels have been measured, calculate the TRFL measurement error. See the Measuring Receiver Personality specifications in the PSA Specification Guide. The Relative Measurement Accuracy specification applies.

NOTE

If you wish to start a new series of measurements, and want to clear the Cal Factor values, press **Measure Setup**, and toggle the **IF BW** to 75 Hz then back to 10 Hz. Press **Set Reference** again.

NOTE

If the frequency setting of the measurement is changed you must clear the Cal Factor values and recalibrate the ranges at the new frequency.

Troubleshooting Hints

The following red status indicators may appear in the measurement result window, or the following error messages on the bottom of the screen:

- `PMError` -- No Power Meter connected or you need to perform the Power Meter Calibration.
- `Uncal` -- You need to perform the Power Meter Calibration.
- `Recal` -- You need to perform the Range Calibration manually. Press **Meas Setup, TRFL Calibrate**.
- `NotReady` -- No data is captured by the Power Meter. If you are using a different power sensor, disconnect the PSA from the UUT and connect the Power Meter to the UUT.
- `Ready` -- The Power Meter has captured the data. If you are using a different power sensor, disconnect the Power Meter from the UUT and connect the PSA and the UUT to continue making measurements.
- `Remain: xxx.xx sec` -- Tells you how long to get the next stable result.

For more information, press **System, Show Errors**.

Tuned RF Level Measurement Example

Figure 3-6

Tuned RF Level Measurement Result (Default)

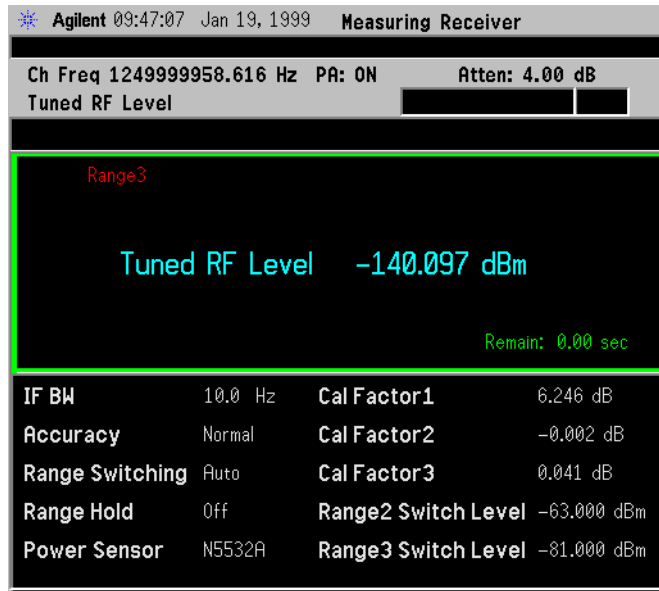
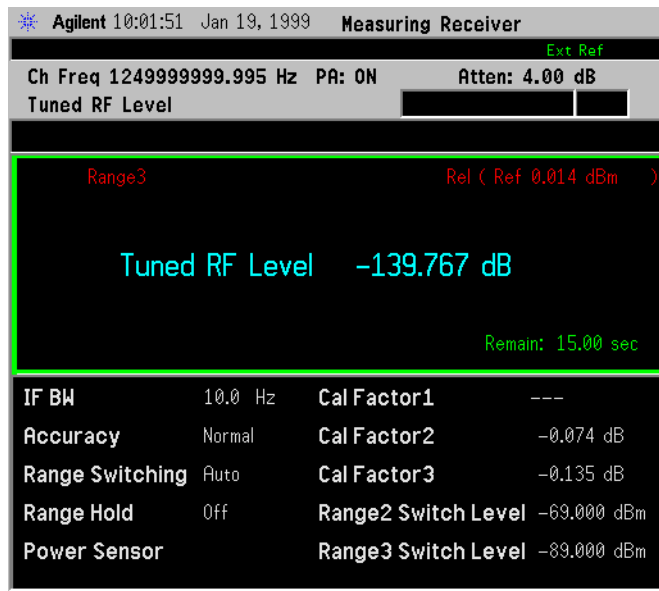

Figure 3-7

Relative Tuned RF Level Measurement Result



Signal Under Test:

RF Frequency: 1.25 GHz; Amplitude: -140.0 dBm; Modulation: Off.

In this example, the measured absolute Tuned RF Level is -140.097 dBm and the measured relative Tuned RF Level is -139.767 dB.

AM Depth Measurement

This procedure describes how to make an AM Depth measurement. In this measurement example, a signal generator is the UUT and is adjusted to deliver a modulated test signal.

The measurement results are:

- AM Depth
- Mod Rate
- Mod Distortion
- Mod SINAD

Measurement Procedure

- Step 1.** Setup the measurement system. See [“System Hardware Connections” on page 40](#). The power meter and N5532A Sensor Module are not used. Connect the signal generator output to the PSA RF input.
- Step 2.** Adjust the signal generator for the desired settings for your test. Refer to the text of [Figure 3-9](#) for example settings.
- Step 3.** Configure the measuring receiver. On the PSA press **Mode**, select **Measuring Receiver, Measure, AM Depth**.
- Step 4.** On the PSA, press **Frequency** and enter the carrier frequency.

NOTE The measuring receiver Frequency Counter measurement can be used to measure and set the carrier frequency on the PSA if the source modulation is turned OFF.

Modulation must be turned off for modulated signals since the modulation may distort the signal spectrum and cause error when using the frequency counter function.

- Step 5.** Press **Restart**.

NOTE Pressing **Restart** optimizes the measuring receiver configuration, and is very important when changes to the measuring receiver settings or the UUT are made. Pressing **Restart** causes the measuring receiver to determine if the PSA settings are correct for the incoming signal, and if they are not, slight changes are made. For example if the UUT depth of modulation is changed, the PSA may require a different IF BW setting for fast and accurate measurements.

Measurement Settings

To adjust measurement settings press **Meas Setup**.

IF BW

Allows the IF Bandwidth to be changed. Pressing this key automatically sets the **IF BW Type** to **Man**.

Range is 1 kHz to 10 MHz.

IF BW Type

Selections are **Auto**, **Man**, and **Min**.

Default setting is **Auto**.

Auto performs an occupied bandwidth measurement on the modulated signal. This measurement occurs at the start of any modulation measurement, and will determine the final IF bandwidth used to analyze the signal. Measurement throughput can be affected since extra time is required during measurement initialization to perform the bandwidth measurement. Auto is usually sufficient for most measurements.

Man (Manual) allows the experienced user to select a bandwidth for demodulation. The value must be chosen with care since a value too low may result in inaccurate results and a value too high will result in unwanted noise and increase the measurement time. In Man mode, measurement throughput is increased over Auto mode since the initialization occupied bandwidth measurement is not automatically performed. When measurements of low rate or high deviation FM/PM signals are necessary, select **Man** type and manually set the IF BW using the **IF BW** key.

Min (Minimal) sets the IF BW to the minimal value necessary to perform the modulation measurement. The minimum IF BW is determined by the Low Pass filter setting and is a value that is $>2 \times$ LP filter setting. This mode works for most signals with a low modulation index. This mode also increases throughput over Auto mode.

To change the average number between **On** and **Off**, press the **Avg Number** key. When setting to **On**, enter the number. The default average setting is **Off** and the default number is 25 when switching to **On**. When the input signal is changed during the average period, wait until the averaging is done or the next averaging period starts.

To change the average mode, toggle the **Avg Mode** key between **Exp** and **Repeat**. The default average mode is **Repeat**.

Trigger Source

Requires option 23A.

Available trigger sources are **Free Run (immediate)**, **Video (IF Envlp)**, **RF Burst**, **Ext Front**, or **Ext Rear**.

Default is **Free Run**.

When trigger source **Video** is selected, the default trigger level is -6 dBm. To adjust, press the **Trig** hardkey then **Level**.

Capture Time

Requires option 23A

Sets the data capture time. Manual and automatic modes are available.

Default is 250ms.

Fast Mode

When fast mode is on, PSA samples fewer points so the capture time and processing time is shorter. This results in faster measurements. The speed improvement is dependent on signal rate and deviation. Accuracy may be affected and the instrument specifications are given with Fast mode Off.

Default is OFF

AM Depth Only

Allows you to select only the AM Depth results. The results for Modulation Rate, Distortion and SINAD are displayed as "---". Measurement speed increases when only AM Depth results are returned. When No is selected, measurement results for AM Depth, Modulation Rate, Modulation Distortion and Modulation SINAD are provided.

Adjusting the Detector, Auto Carrier Frequency, and High and Low Pass Filters

Press **Det/Demod** hard key.

Detector

Selecting the **Peak +** or **Peak -** allows you to check modulation symmetry. For asymmetrical baseband waveforms, selecting **Peak +** or **Peak -** will result in different measurement results.

Peak+/-2

Displays the average value of the positive and negative peak readings.

RMS

Selects the average detector.

Making Measurements

AM Depth Measurement

Peak Hold

Functional only when the detector is currently set to Peak + or Peak -. Holds the maximum peak deviation peak positive or peak negative value from each time measurement. Default is Off.

High Pass Filter

Select between None (<20Hz), 50 Hz, 300 Hz. If option 23B is installed, 400 Hz is available.

Low Pass Filter

Select between 3 kHz, 15 kHz, 30 kHz, 300 kHz and None (>300kHz). If option 23B is installed, 80kHz is available.

Adjusting the View

Press **Trace/View**.

Numeric results is the default setting. Toggle the key to **Demod Waveform** to view the waveform.

Press **Span X scale** and **Amplitude Y scale** to adjust the waveform display.

AM Depth Measurement Example

Figure 3-8 AM Depth Measurement Result (Default)

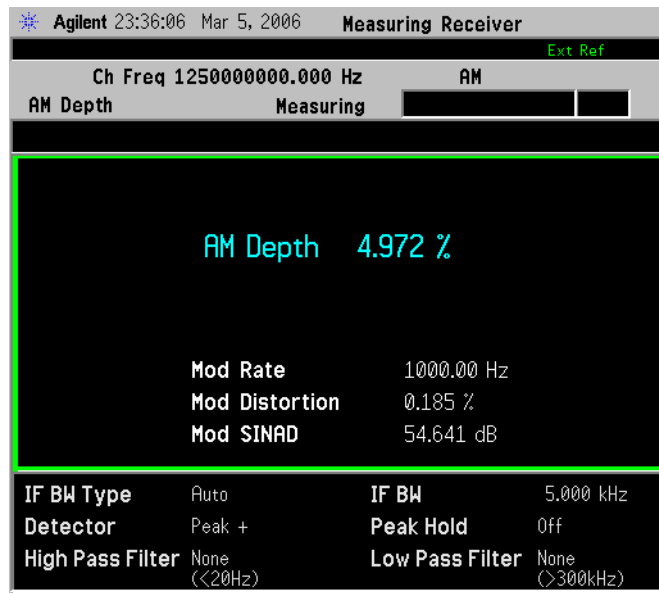
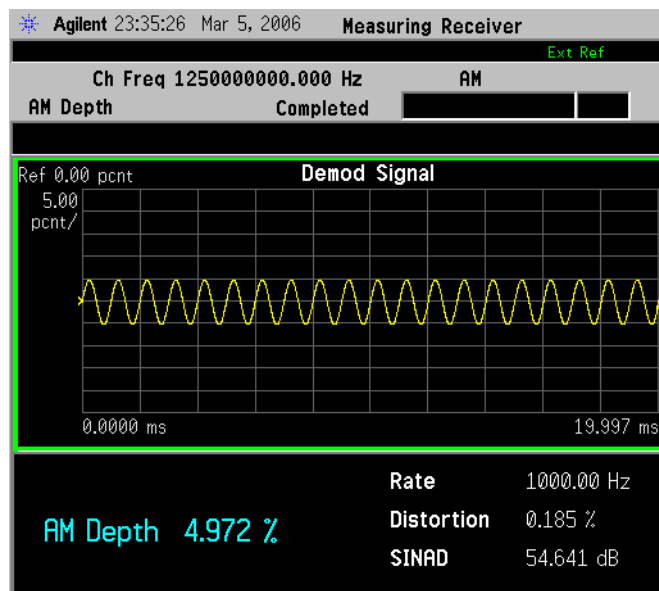

Figure 3-9 AM Depth Measurement Result (Waveform View)



Signal Under Test:

RF Frequency: 1.25 GHz; Amplitude: 0.0 dBm;

AM Depth: 5%; AM Rate: 1 kHz; Modulation: On.

In this example, the measured AM Depth is 4.972%.

FM Deviation Measurement

This procedure describes how to make an FM Deviation measurement. In this measurement example, a signal generator is the UUT and is adjusted to deliver a test signal.

The measurement results are:

- FM Deviation
- Mod Rate
- Mod Distortion
- Mod SINAD

Measurement Procedure

- Step 1.** Setup the measurement system. See [“System Hardware Connections” on page 40](#). The power meter and N5532A Sensor Module are not used. Connect the signal generator output to the PSA RF input.
- Step 2.** Adjust the signal generator for the desired settings for your test. Refer to the text of [Figure 3-11](#) for example settings.
- Step 3.** Configure the measuring receiver. On the PSA press **Mode**, select **Measuring Receiver, Measure, FM Deviation**.
- Step 4.** On the PSA, press **Frequency** and enter the carrier frequency.

NOTE The measuring receiver Frequency Counter measurement can be used to measure and set the carrier frequency on the PSA if the modulation on the source is turned OFF.

Modulation must be turned off for modulated signals since the modulation may distort the signal spectrum and cause error when using the frequency counter function.

- Step 5.** Press **Restart**.

NOTE Pressing **Restart** optimizes the measuring receiver configuration, and is very important when changes to the measuring receiver settings or the UUT are made. Pressing **Restart** causes the measuring receiver to determine if the PSA settings are correct for the incoming signal, and if they are not, slight changes are made.

Measurement Settings

To adjust measurement settings press **Meas Setup**.

IF BW

Allows the IF Bandwidth to be changed. Pressing this key automatically sets the **IF BW Type** to **Man**.

Range is 1 kHz to 10 MHz.

IF BW Type

Selections are **Auto** or **Man**.

Default setting is **Auto**.

Auto performs an occupied bandwidth measurement on the modulated signal. This measurement occurs at the start of any modulation measurement, and will determine the final IF bandwidth used to analyze the signal. Measurement throughput can be affected since extra time is required during measurement initialization to perform the bandwidth measurement. Auto is usually sufficient for most measurements.

Man (Manual) allows the experienced user to select a bandwidth for demodulation. The value must be chosen with care since a value too low may result in inaccurate results and a value too high will result in unwanted noise and increase the measurement time. In Man mode, measurement throughput is increased over Auto mode since the initialization occupied bandwidth measurement is not automatically performed. When measurements of low rate or high deviation FM/PM signals are necessary, select **Man** type and manually set the IF BW using the IF BW key.

To change the average number between **On** and **Off**, press the **Avg Number** key. When setting to **On**, enter the number. The default average setting is **Off** and the default number is 25 when switching to **On**. When the input signal is changed during the average period, wait until the averaging is done or the next averaging period starts.

To change the average mode, toggle the **Avg Mode** key between **Exp** and **Repeat**. The default average mode is **Repeat**.

Trigger Source

Requires option 23A.

Available trigger sources are **Free Run (immediate)**, **Video (IF Envlp)**, **RF Burst**, **Ext Front**, or **Ext Rear**.

Default is **Free Run**.

When trigger source **Video** is selected, the default trigger level is - 6 dBm. To adjust, press the **Trig** hardkey then **Level**.

Making Measurements

FM Deviation Measurement

Capture Time

Requires option 23A

Sets the data capture time. Manual and automatic modes are available.

Default is 250 ms.

Min 1 μ s

Max 10 sec

Fast Mode

When fast mode is on, PSA samples fewer points so the capture time and processing time is shorter. This results in faster measurements. The speed improvement is dependent on signal rate and deviation. Accuracy may be affected and the instrument specifications are given with Fast mode Off.

Default is OFF

FM Dev Only

Allows you to select only the FM Deviation results. The results for Modulation Rate, Distortion and SINAD are displayed as "---". Measurement speed increases when only FM Deviation results are returned. When No is selected, measurement results for FM Deviation, Modulation Rate, Modulation Distortion and Modulation SINAD are provided.

Adjusting the Detector, Auto Carrier Frequency, and High and Low Pass Filters

Press **Det/Demod** hard key.

Detector

Selecting the **Peak +** or **Peak -** allows you to check modulation symmetry. For asymmetrical baseband waveforms, selecting **Peak +** or **Peak -** will result in different measurement results.

Peak+/-2

Displays the average value of the positive and negative peak readings.

RMS

Selects the average detector.

Peak Hold

Functional only when the detector is currently set to Peak + or Peak -. Holds the maximum peak deviation peak positive or peak negative value from each time measurement. Default is Off.

Auto Carrier Frequency

Opt 23A only

Accurate angle demodulation (FM or PM) depends on precisely identifying the carrier frequency. Errors result in phase ramping. The arc tangent of the complex time record is the basis of both FM and PM demodulation. Hence, correcting for this phase ramp is the goal of auto carrier frequency.

The default is Auto Carrier frequency On, and in this state, the analyzer uses an algorithm to estimate the carrier frequency. If you lock the analyzer to an external reference which is coherent with your carrier, no carrier frequency estimation is required, and you do not need to select auto carrier frequency. Without auto carrier frequency, the analyzer uses its center frequency to determine the carrier frequency of your signal.

Considerations When Using Auto Carrier Frequency:

The following situations can bias the phase ramp estimation and the Auto carrier should be turned off:

- Low frequency modulation, such as a periodic signal with fewer than 10 cycles over the time record.
- Phase discontinuities present in digital communications formats.
- Transients, such as carrier turn-on in the middle of the time record. Another example is when measuring the settling time of a VCO or a synthesizer. This causes a DC shift in the demodulators output if it is trying to estimate the carrier frequency before it is stable.

High Pass Filter

Select between None (<20 Hz), 50 Hz, 300 Hz. If option 23B is installed, 400 Hz is available.

Low Pass Filter

Select between 3 kHz, 15 kHz, 30 kHz, 300 kHz and None (>300 kHz). If option 23B is installed, 80 kHz is available.

FM De-Emphasis

Select between None, 25 μ s, 50 μ s, 75 μ s, 750 μ s.

Adjusting the View

Press **Trace/View**.

Numeric results is the default setting. Toggle the key to **Demod Waveform** to view the waveform.

Press **Span X scale** and **Amplitude Y scale** to adjust the waveform display.

FM Deviation Measurement Example

Figure 3-10 FM Deviation Measurement Result (Default)

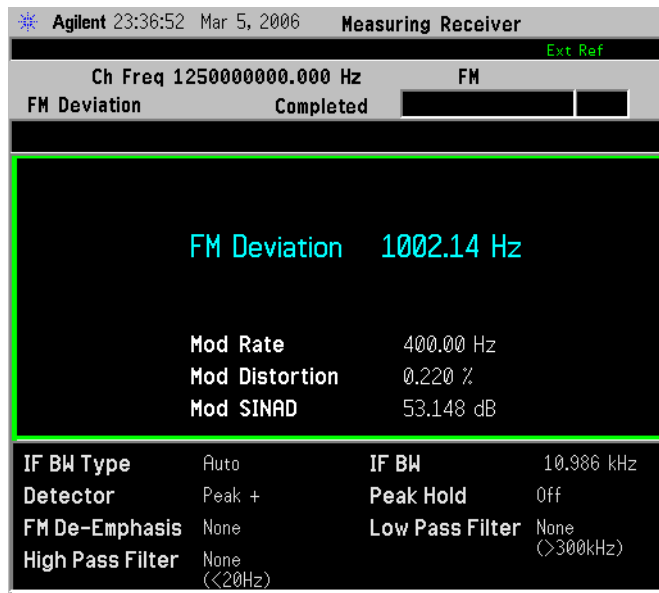
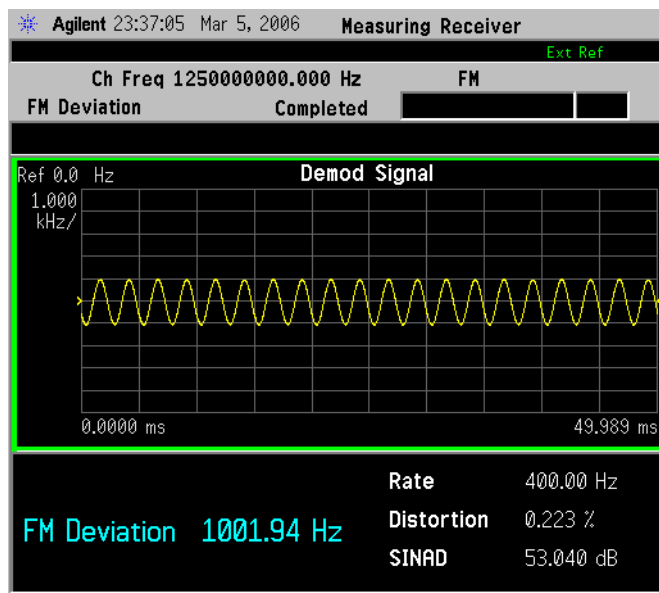

Figure 3-11 FM Deviation Measurement Result (Waveform View)



Signal Under Test:
 RF Frequency: 1.25 GHz; Amplitude: 0.0 dBm;
 FM Deviation: 1000 Hz; FM Rate: 400 Hz; Modulation: On;
 FM De-emphasis: None.

PM Deviation Measurement

This procedure describes how to make a PM Deviation measurement. In this measurement example, a signal generator is the UUT and is adjusted to deliver a test signal. PM Deviation measurements are used to measure and display the phase deviation of the modulation on the signal.

The measurement results are:

- PM Deviation
- Mod Rate
- Mod Distortion
- Mod SINAD

Measurement Procedure

- Step 1.** Setup the measurement system. See [“System Hardware Connections” on page 40](#). The power meter and N5532A Sensor Module are not used. Connect the signal generator output to the PSA RF input.
- Step 2.** Adjust the signal generator for the desired settings for your test. Refer to the text of [Figure 3-13](#) for example settings.
- Step 3.** Configure the measuring receiver. On the PSA press **Mode**, select **Measuring Receiver, Measure, PM Deviation**.
- Step 4.** On the PSA, press **Frequency** and enter the carrier frequency.

NOTE

The measuring receiver Frequency Counter measurement can be used to measure and set the carrier frequency on the PSA if the modulation on the source is turned OFF.

Modulation must be turned off for modulated signals since the modulation may distort the signal spectrum and cause error when using the frequency counter function.

- Step 5.** Press **Restart**.

NOTE

Pressing **Restart** optimizes the measuring receiver configuration, and is very important when changes to the measuring receiver settings or the UUT are made. Pressing **Restart** causes the measuring receiver to determine if the PSA settings are correct for the incoming signal, and if they are not, slight changes are made.

Measurement Settings

To adjust measurement settings press **Meas Setup**.

IF BW

Allows the IF Bandwidth to be changed. Pressing this key automatically sets the **IF BW Type** to **Man**.

Range is 1 kHz to 10 MHz.

IF BW Type

Selections are **Auto** or **Man**.

Default setting is **Auto**.

Auto performs an occupied bandwidth measurement on the modulated signal. This measurement occurs at the start of any modulation measurement, and will determine the final IF bandwidth used to analyze the signal. Measurement throughput can be affected since extra time is required during measurement initialization to perform the bandwidth measurement. Auto is usually sufficient for most measurements.

Man (Manual) allows the experienced user to select a bandwidth for demodulation. The value must be chosen with care since a value too low may result in inaccurate results and a value too high will result in unwanted noise and increase the measurement time. In Man mode, measurement throughput is increased over Auto mode since the initialization occupied bandwidth measurement is not automatically performed. When measurements of low rate or high deviation FM/PM signals are necessary, select **Man** type and manually set the IF BW using the IF BW key.

To change the average number between **On** and **Off**, press the **Avg Number** key. When setting to **On**, enter the number. The default average setting is **Off** and the default number is 25 when switching to **On**. When the input signal is changed during the average period, wait until the averaging is done or the next averaging period starts.

To change the average mode, toggle the **Avg Mode** key between **Exp** and **Repeat**. The default average mode is **Repeat**.

Trigger Source

Requires option 23A.

Available trigger sources are **Free Run (immediate)**, **Video (IF Envlp)**, **RF Burst**, **Ext Front**, or **Ext Rear**.

Default is **Free Run**.

When trigger source **Video** is selected, the default trigger level is -6 dBm. To adjust, press the **Trig** hardkey then **Level**.

Capture Time

Requires option 23A

Sets the data capture time. Manual and automatic modes are available.

Default is 250ms.

Min 1 μ s

Max 10 sec

Fast Mode

When fast mode is on, PSA samples fewer points so the capture time and processing time is shorter. This results in faster measurements. The speed improvement is dependent on signal rate and deviation. Accuracy may be affected and the instrument specifications are given with Fast mode Off.

Default is OFF

PM Dev Only

Allows you to select only the PM Deviation results. The results for Modulation Rate, Distortion and SINAD are displayed as “---”. Measurement speed increases when only PM Deviation results are returned. When No is selected, measurement results for PM Deviation, Modulation Rate, Modulation Distortion and Modulation SINAD are provided.

Adjusting the Detector, Auto Carrier Frequency, and High and Low Pass Filters

Press **Det/Demod** hard key.

Detector

Selecting the Peak + or Peak – allows you to check modulation symmetry. For asymmetrical baseband waveforms, selecting Peak + or Peak – will result in different measurement results.

Peak+/-2

Displays the average value of the positive and negative peak readings.

RMS

Selects the average detector.

Peak Hold

Functional only when the detector is currently set to Peak + or Peak –. Holds the maximum peak deviation peak positive or peak negative value from each time measurement. Default is Off.

Auto Carrier Frequency

Opt 23A only

Accurate angle demodulation (FM or PM) depends on precisely identifying the carrier frequency. Errors result in phase ramping. The arc tangent of the complex time record is the basis of both FM and PM demodulation. Hence, correcting for this phase ramp is the goal of auto carrier frequency.

The default is Auto Carrier frequency On, and in this state, the analyzer uses an algorithm to estimate the carrier frequency. If you lock the analyzer to an external reference which is coherent with your carrier, no carrier frequency estimation is required, and you do not need to select auto carrier frequency. Without auto carrier frequency, the analyzer uses its center frequency to determine the carrier frequency of your signal.

Considerations When Using Auto Carrier Frequency:

The following situations can bias the phase ramp estimation and the Auto carrier should be turned off:

- Low frequency modulation, such as a periodic signal with fewer than 10 cycles over the time record.
- Phase discontinuities present in digital communications formats.
- Transients, such as carrier turn-on in the middle of the time record. Another example is when measuring the settling time of a VCO or a synthesizer. This causes a DC shift in the demodulators output if it is trying to estimate the carrier frequency before it is stable.

High Pass Filter

Select between None (<20 Hz), 50 Hz, 300 Hz. If option 23B is installed, 400 Hz is available.

Low Pass Filter

Select between 3 kHz, 15 kHz, 30 kHz, 300 kHz and None (>300 kHz). If option 23B is installed, 80 kHz is available.

FM De-Emphasis

Select between None, 25 μ s, 50 μ s, 75 μ s, 750 μ s.

Adjusting the View

Press **Trace/View**.

Numeric results is the default setting. Toggle the key to **Demod Waveform** to view the waveform.

Press **Span X scale** and **Amplitude Y scale** to adjust the waveform display.

PM Deviation Measurement Example

Figure 3-12

PM Deviation Measurement Result

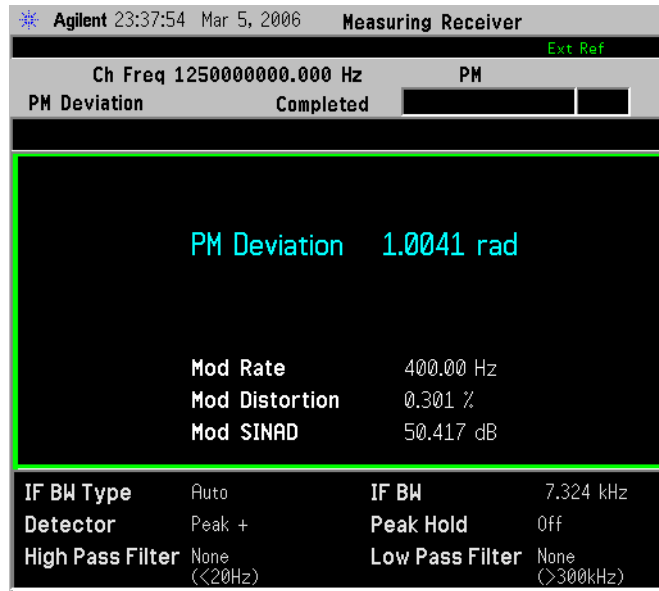
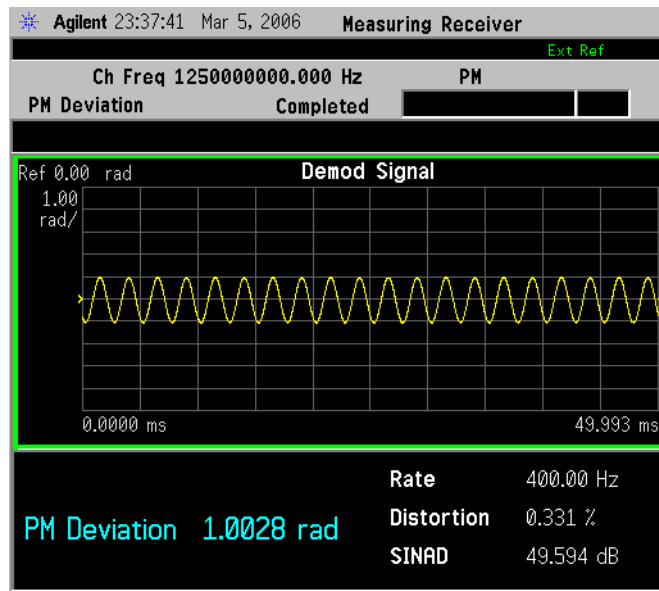

Figure 3-13

PM Deviation Measurement Result (Waveform View)



Signal Under Test:

RF Frequency: 1.25 GHz; Amplitude: 0.0 dBm;

PM Deviation: 1rad; PM Rate: 400 Hz; Modulation: On.

Modulation Rate Measurement

This procedure describes how to make a Modulation Rate measurement. In this measurement example, a signal generator is the UUT and is adjusted to deliver a test signal. Modulation Rate measurement is used to measure and display the modulation rate of the signal.

NOTE You can make Modulation Rate measurements without a Power Meter since it is the PSA that measures the Modulation Rate.

Measurement Procedure

NOTE For AM/FM/PM modulated signals, the modulation may distort the original signal spectrum and the instrument may not determine the correct carrier frequency.

Since the result of this measurement is used to calculate follow-on measurements, the alternative is to input the carrier frequency manually by pressing **Frequency Channel** key. This avoid the need to make Frequency Counter measurement before other measurements.

CAUTION Press the Restart key to optimize the measuring receiver configuration if you make any changes to the UUT or to the measuring receiver settings after you make your first measurement.

Step 1. Setup the measurement system. See “[System Hardware Connections](#)” on page 40.

To measure the Modulation Rate, you do not have to perform the Power Meter calibration.

Step 2. Make sure you have selected **Measuring Receiver** mode in the **MODE** key menu.

Step 3. Adjust the signal generator to the desired settings for your test.

Step 4. Perform a Frequency Counter measurement to accurately determine the center frequency of your signal.

When the measurement is completed, the measurement result will display.

Step 5. Press **Modulation Rate** key. Wait for the measurement to be completed.

When the measurement is completed, the measurement result will display.

NOTE

The Modulation Rate measurement is used in conjunction with the following three measurements:

- “AM Depth Measurement” on page 81
- “FM Deviation Measurement” on page 86
- “PM Deviation Measurement” on page 91

Step 6. To adjust measurement settings, press **Meas Setup**, then:

1. To change the IF BW, press the **IF BW** key and enter the bandwidth value and unit. Meanwhile, the **IF BW Type** will be automatically set to **Man**. The default setting is **100 kHz**.
2. To change the IF BW Type, press the **IF BW Type** key to select from **Auto**, **Man** and **Min**.

Usually **Auto** mode is sufficient for most measurement conditions. When you need to measure low rate signals, you can select **Man** type to set the actual signal bandwidth by pressing **IF BW**.

Selecting **Min** type allows you to use the minimum IF bandwidth to perform the modulation measurement. The minimum IF bandwidth is set as twice wider than Low Pass Filter.

NOTE

If you specify a Low Pass Filter, it's recommended to select Min:
 $IF\ BW > 2 * LP\ Filter$

3. To change the average number between **On** and **Off**, press the **Avg Number** key. When setting to **On**, enter the number. The default average setting is **Off** and the default number is 25 when switching to **On**. When the input signal is changed during the average period, wait until the averaging is done or the next averaging period starts.
4. To change the average mode, toggle the **Avg Mode** key between **Exp** and **Repeat**. The default average mode is **Repeat**.

Step 7. To adjust the detector, press **Det/Demod**, **Detector** to select a detector:

1. Pressing the **PEAK-** or **PEAK+** key allows you to check modulation symmetry.
2. Pressing the **PEAK+/-2** key allows you to display the average value of the positive and negative peak readings.
3. Pressing the **RMS** key allows you to select the average detector.
4. Toggle the **Peak Hold** key between **On** and **Off**. The default setting is **Off**.

Step 8. To adjust the filters, press **Det/Demod**, then:

1. Press **High Pass Filter** to select a value.

Making Measurements

Modulation Rate Measurement

2. Press **Low Pass Filter** to select a value.
3. Press **FM De-Emphasis** to select a value. This key is enabled only when the **Modulation Mode** is **FM**.
4. Press **Modulation Mode** to select from **AM**, **FM** and **PM**.

Step 9. To adjust the display, press **AMPLITUDE/Y Scale**, then:

1. Press the **Display Unit** key and select a display unit key. The default setting is **Hz**.
2. Press the **Display Mode** key to toggle between **Normal** and **Ratio**. The default setting is **Normal**.
3. Press the **Ratio Ref** key to toggle between **Auto** and **Man**. When you select **Man**, input the reference value and unit. When the reference is set to 0 or the measurement result is 0 under log ratio mode, the result displayed is “- - -”.
4. Press the **Ratio Mode** key to toggle between **Log** and **Linear**.

Modulation Rate Measurement Example

Figure 3-14

AM Modulation Rate Measurement Result

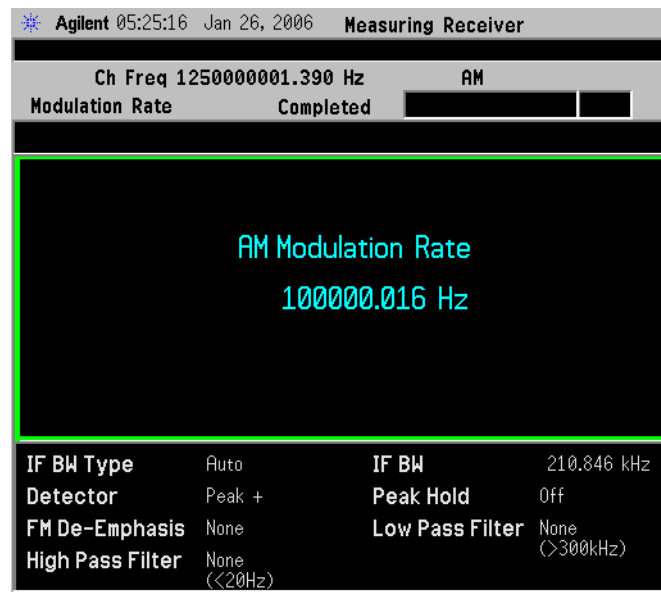

Signal Under Test: RF Frequency: 1.25 GHz; Amplitude: 0.0 dBm; AM Depth: 10%; AM Rate: 100 kHz; AM: On; Modulation: On.
 In this example, the measured AM Modulation Rate is 100000.016 Hz.

Figure 3-15 FM Modulation Rate Measurement Result

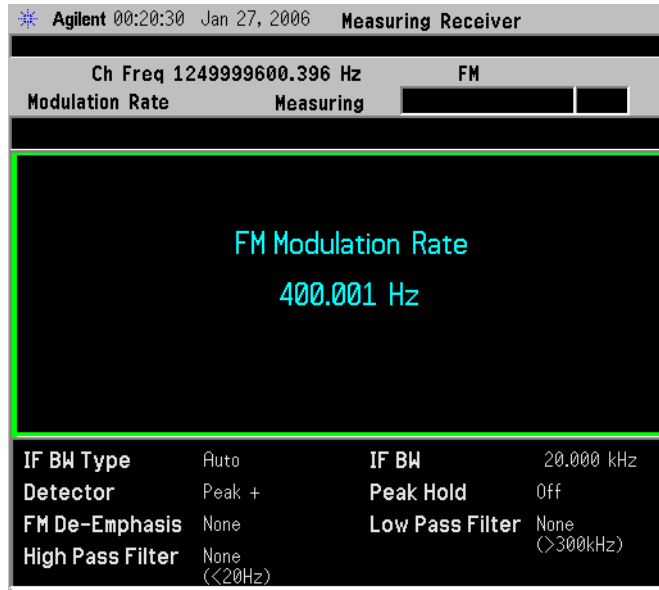

Signal Under Test: RF Frequency: 1.25 GHz; Amplitude: 0.0 dBm; FM Deviation: 100 kHz; FM Rate: 400 Hz; Modulation: On. Set the N5531S FM De-emphasis to None.

Figure 3-16 PM Modulation Rate Measurement Result

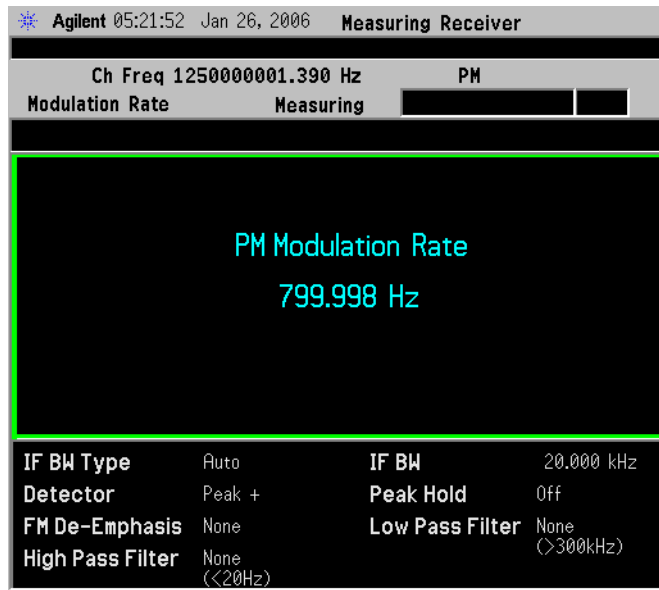

Signal Under Test:
 RF Frequency: 1.25 GHz; Amplitude: 0.0 dBm;
 PM Deviation: 1 rad; PM Rate: 800 Hz; Modulation: On.

Modulation Distortion Measurement

This procedure describes how to make a Modulation Distortion measurement. In this measurement example, a signal generator is the UUT and is adjusted to deliver a test signal. Modulation Distortion measurement is used to measure and display the modulation distortion of the signal.

NOTE You can make Modulation Distortion measurements without a Power Meter since it is the PSA that measures the Modulation Distortion.

Measurement Procedure

NOTE For AM/FM/PM modulated signals, the modulation may distort the original signal spectrum and the instrument may not determine the correct carrier frequency.

Since the result of this measurement is used to calculate follow-on measurements, the alternative is to input the carrier frequency manually by pressing **Frequency Channel** key. This avoid the need to make Frequency Counter measurement before other measurements.

CAUTION Press the Restart key to optimize the measuring receiver configuration if you make any changes to the UUT or to the measuring receiver settings after you make your first measurement.

Step 1. Setup the measurement system. See [“System Hardware Connections” on page 40](#).

To measure the Modulation Distortion, you do not have to perform the Power Meter calibration.

Step 2. Make sure you have selected **Measuring Receiver** mode in the **MODE** key menu.

Step 3. Adjust the signal generator to the desired settings for your test.

Step 4. Perform a Frequency Counter measurement to accurately determine the center frequency of your signal.

When the measurement is completed, the measurement result will display.

Step 5. Press **Modulation Distortion** key. Wait for the measurement to be completed.

When the measurement is completed, the measurement result will display.

Making Measurements
 Modulation Distortion Measurement

NOTE The Modulation Distortion measurement is used in conjunction with the following three measurements:

- “AM Depth Measurement” on page 81
- “FM Deviation Measurement” on page 86
- “PM Deviation Measurement” on page 91

First run one of these three measurements, then press the **Modulation Distortion** key. Or Manually select the modulation by pressing **Det/Demod** and toggling **Modulation Mode** among **AM**, **FM** and **PM**.

Step 6. To adjust measurement settings, press **Meas Setup**, then:

1. To change the IF BW, press the **IF BW** key and enter the bandwidth value and unit. Meanwhile, the **IF BW Type** will be automatically set to **Man**. The default setting is **100 kHz**.
2. To change the IF BW Type, press the **IF BW Type** key to select from **Auto**, **Man** and **Min**. Usually Auto mode is sufficient for most measurement conditions. When you need to measure low rate signals, you can select **Man** mode to set the actual signal bandwidth by pressing **IF BW**. **Min** type sets the **IF BW** according to the **Low Pass Filter**.

NOTE If you specify a Low Pass Filter, it's recommended to select Min:
 $IF\ BW > 2 * LP\ Filter$

3. To change the average number between **On** and **Off**, press the **Avg Number** key. When setting to **On**, enter the number. The default average setting is **Off** and the default number is 25 when switching to **On**. When the input signal is changed during the average period, wait until the averaging is done or the next averaging period starts.
4. To change the average mode, toggle the **Avg Mode** key between **Exp** and **Repeat**. The default average mode is **Repeat**.

Step 7. To adjust the detector, press **Det/Demod**, **Detector** to select a detector:

1. Pressing the **PEAK-** or **PEAK+** key allows you to check modulation symmetry.
2. Pressing the **PEAK+/-2** key allows you to display the average value of the positive and negative peak readings.
3. Pressing the **RMS** key allows you to select the average detector.
4. Toggle the **Peak Hold** key between **On** and **Off**. The default setting is **Off**.

Step 8. To adjust the filters, press **Det/Demod**, then:

1. Press **High Pass Filter** to select a value.
2. Press **Low Pass Filter** to select a value.
3. Press **FM De-Emphasis** to select a value. This key is enabled only when the **Modulation Mode** is **FM**.
4. Press **Modulation Mode** to select from **AM**, **FM** and **PM**.

Step 9. To adjust the display, press **AMPLITUDE/Y Scale**, then:

1. Press the **Display Unit** key and select a display unit key. The default setting is %.
2. Press the **Display Mode** key to toggle between **Normal** and **Ratio**. The default setting is **Normal**.
3. Press the **Ratio Ref** key to toggle between **Auto** and **Man**. When you select **Man**, input the reference value and unit. When the reference is set to 0 or the measurement result is 0 under log ratio mode, the result displayed is “- - -”.
4. Press the **Ratio Mode** key to toggle between **Log** and **Linear**.

Modulation Distortion Measurement Example

Figure 3-17

AM Modulation Distortion Measurement Result

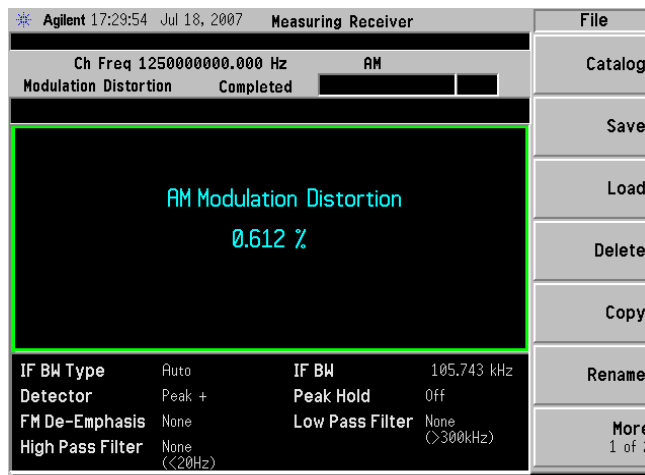

Signal Under Test: RF Frequency: 1.25 GHz; Amplitude: 0.0 dBm; AM Depth: 10%; AM Rate: 100 kHz; Modulation: On.

Making Measurements
 Modulation Distortion Measurement

Figure 3-18 FM Modulation Distortion Measurement Result

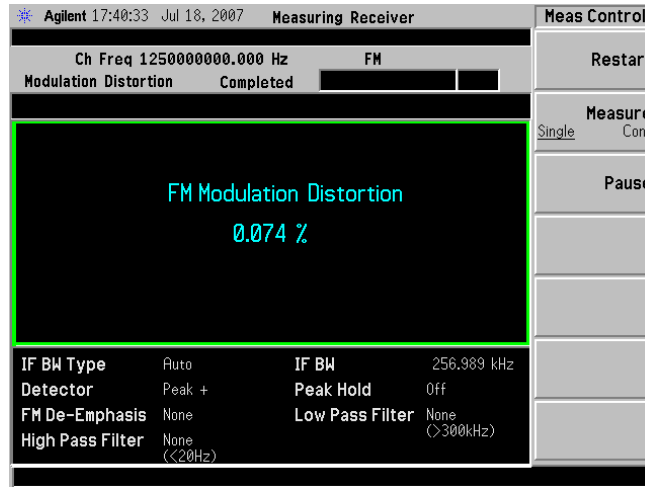

Signal Under Test: RF Frequency: 1.25 GHz; Amplitude: 0.0 dBm; FM Deviation: 100 kHz; FM Rate: 400 Hz; Modulation: On. Set the N5531S FM De-emphasis to None.

Figure 3-19 PM Modulation Distortion Measurement Result

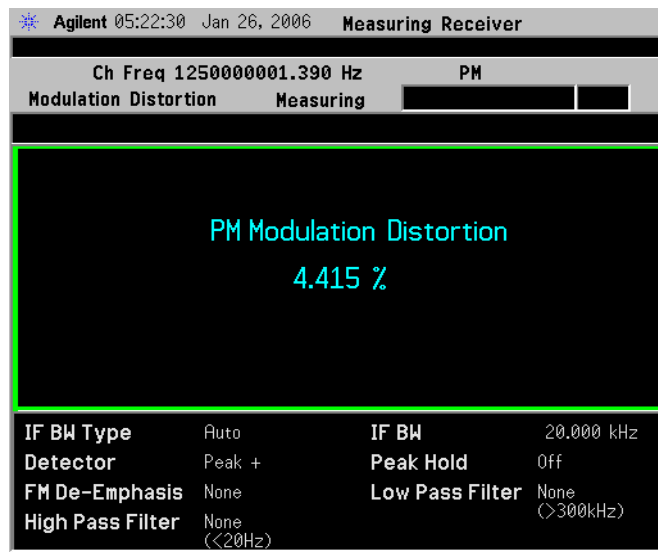

Signal Under Test:
 RF Frequency: 1.25 GHz; Amplitude: - 30.0 dBm;
 PM Deviation: 150 rad; PM Rate: 400 Hz; Modulation: On.

Modulation SINAD Measurement

This procedure describes how to make a Modulation SINAD measurement. In this measurement example, a signal generator is the UUT and is adjusted to deliver a test signal. Modulation SINAD measurement is used to measure and display the modulation SINAD of the signal.

NOTE You can make Modulation SINAD measurements without a Power Meter since it is the PSA that measures the Modulation SINAD.

Measurement Procedure

NOTE For AM/FM/PM modulated signals, the modulation may distort the original signal spectrum and the instrument may not determine the correct carrier frequency.

Since the result of this measurement is used to calculate follow-on measurements, the alternative is to input the carrier frequency manually by pressing **Frequency Channel** key. This avoid the need to make Frequency Counter measurement before other measurements.

CAUTION Press the Restart key to optimize the measuring receiver configuration if you make any changes to the UUT or to the measuring receiver settings after you make your first measurement.

Step 1. Setup the measurement system. See [“System Hardware Connections” on page 40](#).

To measure the Modulation SINAD, you do not have to perform the Power Meter calibration.

Step 2. Make sure you have selected **Measuring Receiver** mode in the **MODE** key menu.

Step 3. Adjust the signal generator to the desired settings for your test.

Step 4. Perform a Frequency Counter measurement to accurately determine the center frequency of your signal.

When the measurement is completed, the measurement result will display.

Step 5. Press **Modulation SINAD** key. Wait for the measurement to be completed.

When the measurement is completed, the measurement result will display.

NOTE The Modulation Rate measurement is used in conjunction with the following three measurements:

- “AM Depth Measurement” on page 81
- “FM Deviation Measurement” on page 86
- “PM Deviation Measurement” on page 91

First run one of these three measurements, then press the **Modulation SINAD** key. Or Manually select the modulation by pressing **Det/Demod** and toggling **Modulation Mode** among **AM**, **FM** and **PM**.

Step 6. To adjust the measurement settings, press **Meas Setup**, then:

1. To change the IF BW, press the **IF BW** key and enter the bandwidth value and unit. Meanwhile, the **IF BW Type** will be automatically set to **Man**. The default setting is **100 kHz**.
2. To change the IF BW Type, press the **IF BW Type** key to select from **Auto**, **Man** and **Min**. Usually Auto mode is sufficient for most measurement conditions. When you need to measure low rate signals, you can select **Man** mode to set the actual signal bandwidth by pressing **IF BW**. **Min** type sets the **IF BW** according to the **Low Pass Filter**.

NOTE If you specify a Low Pass Filter, it's recommended to select Min:
 $IF\ BW > 2 * LP\ Filter$

3. To change the average number between **On** and **Off**, press the **Avg Number** key. When setting to **On**, enter the number. The default average setting is **Off** and the default number is 25 when switching to **On**. When the input signal is changed during the average period, wait until the averaging is done or the next averaging period starts.
4. To change the average mode, toggle the **Avg Mode** key between **Exp** and **Repeat**. The default average mode is **Repeat**.

Step 7. To adjust the detectors, press **Det/Demod**, **Detector** to select a detector:

1. Pressing the **PEAK-** or **PEAK+** key allows you to check modulation symmetry.
2. Pressing the **PEAK+/-2** key allows you to display the average value of the positive and negative peak readings.
3. Pressing the **RMS** key to select the average detector.
4. Toggle the **Peak Hold** key between **On** and **Off**. The default setting is **Off**.

Step 8. To adjust the filters, press **Det/Demod**, then:

1. Press **High Pass Filter** to select a value.
2. Press **Low Pass Filter** to select a value.
3. Press **FM De-Emphasis** to select a value. This key is enabled only when the **Modulation Mode** is **FM**.
4. Press **Modulation Mode** to select from **AM**, **FM** and **PM**.

Step 9. To adjust the display, press **AMPLITUDE/Y Scale**, then:

1. Press the **Display Unit** key and select a display unit key. The default setting is **dB**.
2. Press the **Display Mode** key to toggle between **Normal** and **Ratio**. The default setting is **Normal**.
3. Press the **Ratio Ref** key to toggle between **Auto** and **Man**. When you select **Man**, input the reference value and unit. When the reference is set to 0 or the measurement result is 0 under log ratio mode, the result displayed is “- - -”.
4. Press the **Ratio Mode** key to toggle between **Log** and **Linear**.

Modulation SINAD Measurement Example

Figure 3-20

AM Modulation SINAD Measurement Result

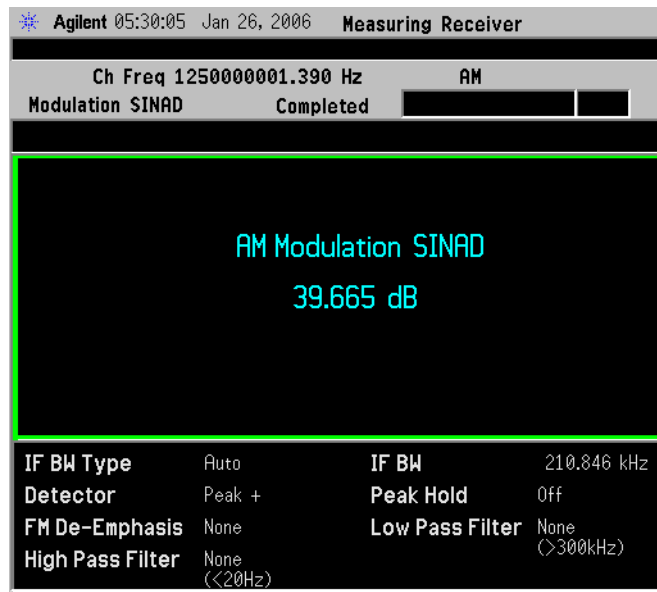

Signal Under Test: RF Frequency: 1.25 GHz; Amplitude: -30.0 dBm; AM Depth: 10%; AM Rate: 100 kHz; Modulation: On.
 In this example, the measured AM Modulation SINAD is 39.665 dB.

Figure 3-21 FM Modulation SINAD Measurement Result

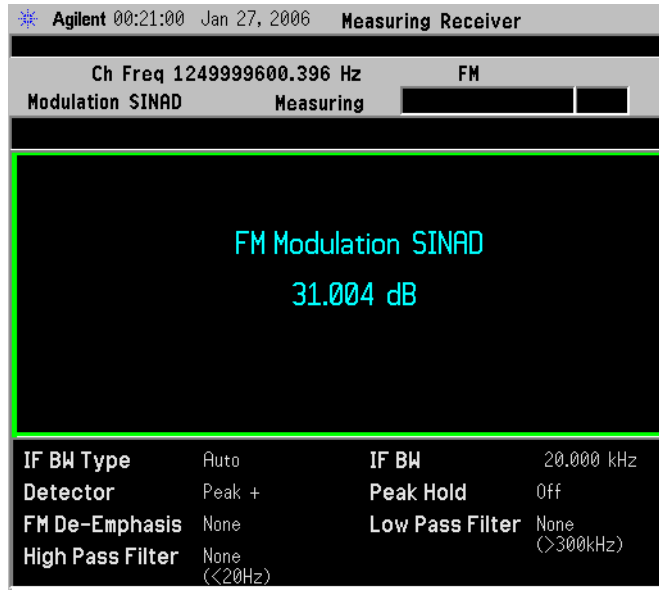

Signal Under Test: RF Frequency: 1.25 GHz; Amplitude: -30.0 dBm; FM Deviation: 100 kHz; FM Rate: 400 Hz; Modulation: On. Set the N5531S FM De-emphasis to None. In this example, the measured FM Modulation SINAD 31.004 dB.

Figure 3-22 PM Modulation SINAD Measurement Result

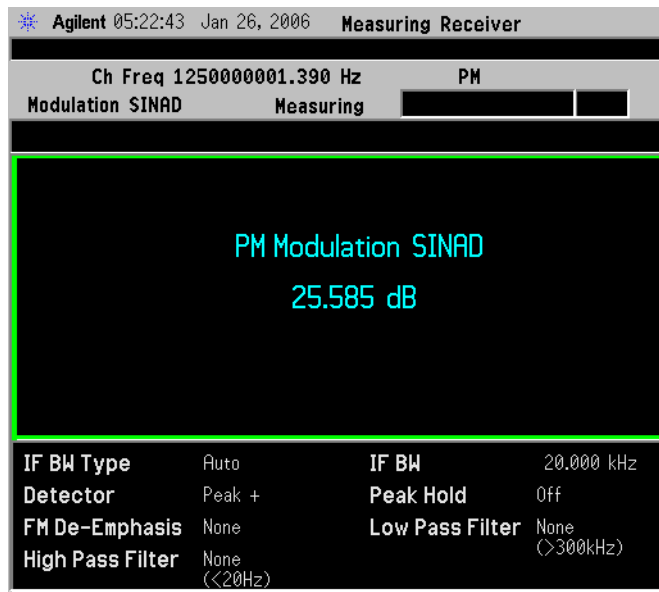

Signal Under Test: RF Frequency: 1.25 GHz; Amplitude: -30.0 dBm; PM Deviation: 150 rad; PM Rate: 400 Hz; Modulation: On. In this example, the measured PM Modulation SINAD 25.585 dB.

Audio Frequency Measurement

This procedure describes how to make a Audio Frequency measurement. In this measurement example, a signal generator is the UUT and is adjusted to deliver a test signal. Audio Frequency measurement is used to measure and display the frequency of an audio signal. The measurable frequency range is from 20 Hz to 250 kHz.

CAUTION Make sure your input audio signal is under the allowed maximum safe input level printed near the input connector.

NOTE You can make Audio measurements without a Power Meter since it is the PSA that measures the Audio Frequency.

TIP Make sure the input and output impedance are matched. The PSA audio input has a high impedance of 100 k Ω . The output impedance of your audio source may impact the RMS level reading.

Measurement Procedure

Figure 3-23 Audio Test Connection Diagram

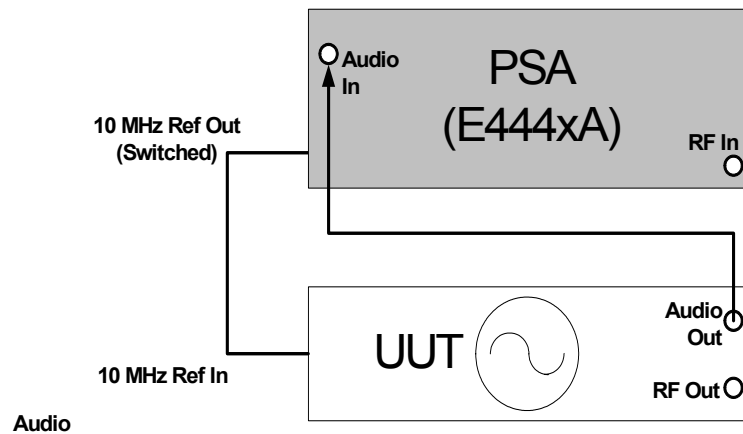

CAUTION Press the Restart key to optimize the measuring receiver configuration if you make any changes to the UUT or to the measuring receiver settings after you make your first measurement.

- Step 1.** Set up the system. See [Figure 3-23, “Audio Test Connection Diagram.”](#)
- Step 2.** Make sure you have selected **Measuring Receiver** mode in the **MODE** key menu.
- Step 3.** Adjust the signal generator to the desired settings for your test.

Making Measurements
Audio Frequency Measurement

Step 4. Press **Audio Frequency** key.

When the measurement is completed, the measurement result will display.

Step 5. To adjust measurement settings, press **Meas Setup**, then:

1. To change the average number between **On** and **Off**, press the **Avg Number** key. When setting to **On**, enter the number. When the input signal is changed during the average period, wait until the averaging is done or the next averaging period starts.
2. To change the average mode, toggle the **Avg Mode** key between **Exp** and **Repeat**. The default average mode is **Repeat**.

Step 6. To adjust audio range settings, see [Step 6 on page 112](#).

Step 7. To adjust the display, press **AMPLITUDE/Y Scale**, then:

1. Press the **Display Unit** key and select a display unit key. The default setting is **Hz**.
2. Press the **Display Mode** key to toggle between **Normal** and **Ratio**. The default setting is **Normal**.
3. Press the **Ratio Ref** key to toggle between **Auto** and **Man**. When you select **Man**, input the reference value and unit. When the reference is set to 0 or the measurement result is 0 under log ratio mode, the result displayed is “- - -”.
4. Press the **Ratio Mode** key to toggle between **Log** and **Linear**.

Audio Frequency Measurement Example

Figure 3-24

Audio Frequency Measurement Result

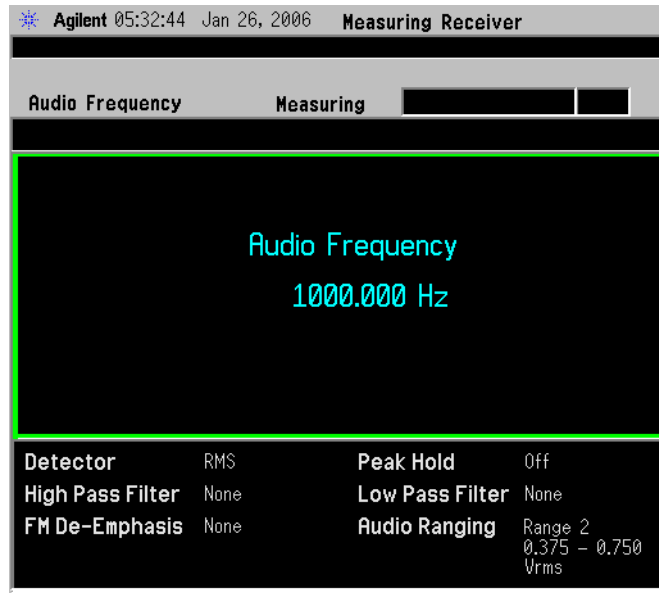

Signal Under Test:

Audio Frequency: 1000 Hz; Amplitude: 1.0 V_p; Modulation: Off.

In this example, the measured Audio Frequency is 1000.000 Hz.

Audio AC Level Measurement

This procedure describes how to make a Audio AC Level measurement. In this measurement example, a signal generator is the UUT and is adjusted to deliver a test signal. Audio AC Level measurement is used to measure and display the true RMS level of an audio signal. The maximum measurable input level is 3 V_{rms}.

CAUTION Make sure your input audio signal is under the allowed maximum safe input level printed near the audio input connector.

NOTE You can make Audio AC Level measurements without a Power Meter since it is the PSA that measures the Audio AC Level.

TIP Make sure the input and output impedance are matched. The PSA audio input has a high impedance of 100 k Ω . The output impedance of your audio source may impact the RMS level reading.

Measurement Procedure

CAUTION Press the Restart key to optimize the measuring receiver configuration if you make any changes to the UUT or to the measuring receiver settings after you make your first measurement.

- Step 1.** Setup the system. See [Figure 3-23, “Audio Test Connection Diagram.”](#)
- Step 2.** Make sure you have selected **Measuring Receiver** mode in the **MODE** key menu.
- Step 3.** Adjust the signal generator to the desired settings for your test.
- Step 4.** Press **Audio AC Level** key. Wait for the measurement to be completed.

When the measurement is completed, the measurement result will display.

- Step 5.** To adjust the measurement settings, press **Meas Setup**, then:
 1. To change the average number between **On** and **Off**, press the **Avg Number** key. When setting to **On**, enter the number. The default average setting is **Off** and the default number is 25 when switching to **On**. When the input signal is changed during the average period, wait until the averaging is done or the next averaging period starts.
 2. To change the average mode, toggle the **Avg Mode** key between **Exp** and **Repeat**. The default average mode is **Repeat**.

- Step 6.** To adjust the audio range settings, press **Input/Output** and **Audio**

Ranging, then select a range from **Rang 0** to **Range 4**.

For example, if the audio signal under test is 1 V_p and the displayed audio signal is 0.707 V_{rms}, select Rang 2. For ranging information, see “[Audio Ranging](#)” on page 146.

You also can press **Audio Input Ranging**, to turn auto input ranging off and on, for audio measurements.

Step 7. To adjust the display, press **AMPLITUDE/Y Scale**, then:

1. Press the **Display Unit** key and select a display unit key. The default setting is V_{rms}.
2. Press the **Display Mode** key to toggle between **Normal** and **Ratio**. The default setting is **Normal**.
3. Press the **Ratio Ref** key to toggle between **Auto** and **Man**. When you select **Man**, input the reference value and unit. When the reference is set to 0 or the measurement result is 0 under log ratio mode, the result displayed is “- - -”.
4. Press the **Ratio Mode** key to toggle between **Log** and **Linear**.

Audio AC Level Measurement Example

Figure 3-25

Audio AC Level Measurement Result

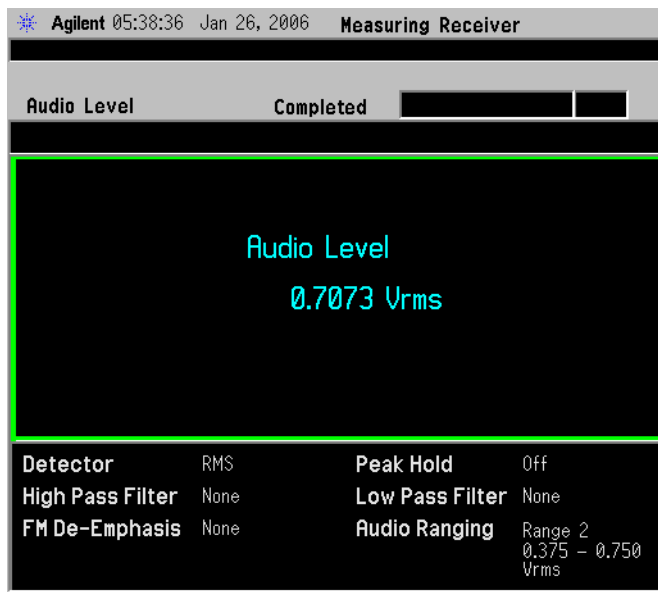

Signal Under Test:
 Audio Frequency: 1000 Hz; Amplitude: 1.0 V_p; Modulation: Off.
 In this example, the measured Audio AC Level is 0.7073 V_{rms}.

Audio Distortion Measurement

This procedure describes how to make a Audio Distortion measurement. In this measurement example, a signal generator is the UUT and is adjusted to deliver a test signal. Audio Distortion measurement is used to measure and display the amount of audio distortion applied to the audio signal by performing the ratio of harmonic and noise power against fundamental power. The measurable frequency range is from 20 Hz to 250 kHz.

CAUTION Make sure your input audio signal is under the allowed maximum safe input level printed near the audio input connector.

NOTE You can make Audio Distortion measurements without a Power Meter since it is the PSA that measures the Audio Distortion.

TIP Make sure the input and output impedance are matched. The PSA audio input has a high impedance of 100 k Ω . The output impedance of your audio source may impact the RMS level reading.

Measurement Procedure

CAUTION Press the Restart key to optimize the measuring receiver configuration if you make any changes to the UUT or to the measuring receiver settings after you make your first measurement.

- Step 1.** Setup the system. See [Figure 3-23, “Audio Test Connection Diagram.”](#)
- Step 2.** Make sure you have selected **Measuring Receiver** mode in the **MODE** key menu.
- Step 3.** Adjust the signal generator to the desired settings for your test.
- Step 4.** Press **Audio Frequency** key. Wait for the measurement to be completed.
 When the measurement is completed, the measurement result will display.
- Step 5.** To make an accurate measurement, select the appropriate Audio Range. See [Step 6 on page 112](#).
- Step 6.** To adjust the measurement settings, press **Meas Setup**, then:
 1. To change the average number between **On** and **Off**, press the **Avg Number** key. When setting to **On**, enter the number. The default average setting is **Off** and the default number is 25 when switching to **On**. When the input signal is changed during the average period,

wait until the averaging is done or the next averaging period starts.

2. To change the average mode, toggle the **Avg Mode** key between **Exp** and **Repeat**. The default average mode is **Repeat**.

Step 7. To adjust the display, press **AMPLITUDE/Y Scale**, then:

1. Press the **Display Unit** key and select a display unit key. The default setting is %.
2. Press the **Display Mode** key to toggle between **Normal** and **Ratio**. The default setting is **Normal**.
3. Press the **Ratio Ref** key to toggle between **Auto** and **Man**. When you select **Man**, input the reference value and unit. When the reference is set to 0 or the measurement result is 0 under log ratio mode, the result displayed is “- - -”.
4. Press the **Ratio Mode** key to toggle between **Log** and **Linear**.

Audio Distortion Measurement Example

Figure 3-26

Audio Distortion Measurement Results

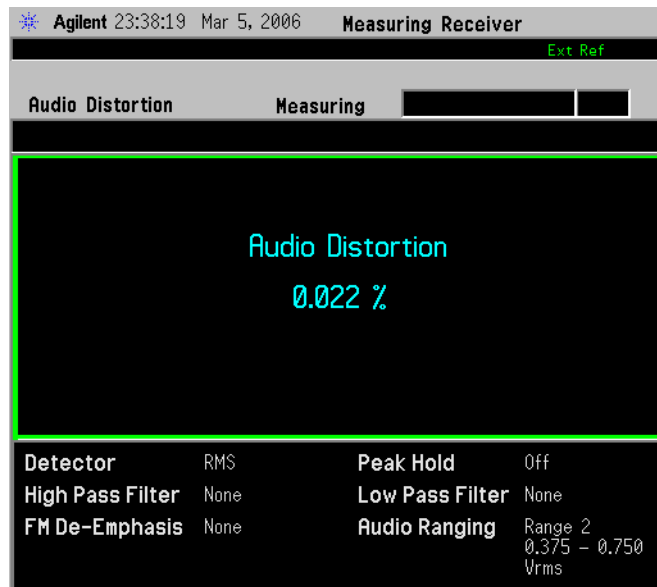

Signal under test:

Audio Frequency: 1000 Hz; Amplitude: 1 V_p; Modulation: Off.

In this example, the measured Audio Distortion is 0.022%.

Audio SINAD Measurement

This procedure describes how to make a Audio SINAD measurement. In this measurement example, a signal generator is the UUT and is adjusted to deliver a test signal. Audio SINAD measurement is used to measure and display the amount of audio SINAD applied to an audio signal by performing the ratio of fundamental power against harmonic and noise power. The Audio SINAD is reciprocal of Audio Distortion measured by Audio Distortion measurement.

CAUTION Make sure your input audio signal is under the allowed maximum safe input level printed near the audio input connector.

NOTE You can make Audio SINAD measurements without a Power Meter since it is the PSA that measures the Audio SINAD.

TIP Make sure the input and output impedance are matched. The PSA audio input has a high impedance of 100 k Ω . The output impedance of your audio source may impact the RMS level reading.

Measurement Procedure

CAUTION Press the Restart key to optimize the measuring receiver configuration if you make any changes to the UUT or to the measuring receiver settings after you make your first measurement.

- Step 1.** Setup the system. See [Figure 3-23, “Audio Test Connection Diagram.”](#)
- Step 2.** Make sure you have selected **Measuring Receiver** mode in the **MODE** key menu.
- Step 3.** Adjust the signal generator to the desired settings for your test.
- Step 4.** Press **Audio SINAD** key. Wait for the measurement to be completed.
When the measurement is completed, the measurement result will display.
- Step 5.** To make an accurate measurement, select the appropriate Audio Range. See [Step 6 on page 112](#).

Step 6. To adjust the measurement settings, press **Meas Setup**, then:

1. To change the average number between **On** and **Off**, press the **Avg Number** key. When setting to **On**, enter the number. The default average setting is **Off** and the default number is 25 when switching to **On**. When the input signal is changed during the average period, wait until the averaging is done or the next averaging period starts.
2. To change the average mode, toggle the **Avg Mode** key between **Exp** and **Repeat**. The default average mode is **Repeat**.

Step 7. To adjust the display, press **AMPLITUDE/Y Scale**, then:

1. Press the **Display Unit** key and select a display unit key. The default setting is **dB**.
2. Press the **Display Mode** key to toggle between **Normal** and **Ratio**. The default setting is **Normal**.
3. Press the **Ratio Ref** key to toggle between **Auto** and **Man**. When you select **Man**, input the reference value and unit. When the reference is set to 0 or the measurement result is 0 under log ratio mode, the result displayed is “- - -”.
4. Press the **Ratio Mode** key to toggle between **Log** and **Linear**.

Audio SINAD Measurement Example

Figure 3-27

Audio SINAD Measurement Result

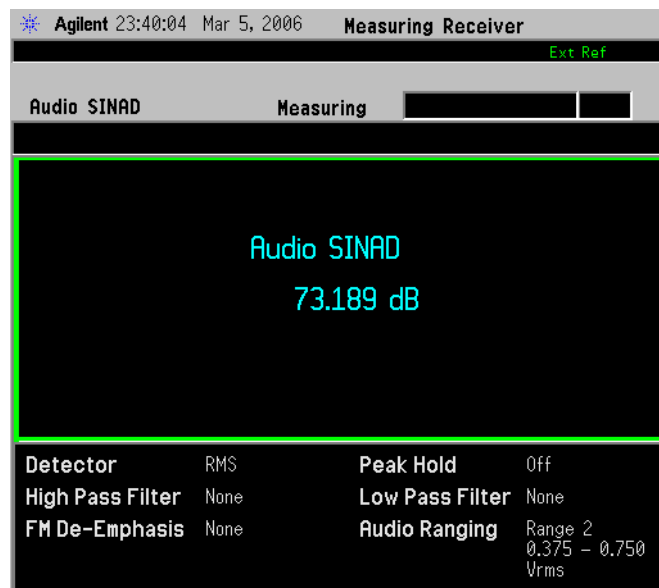

Signal Under Test:

Audio Frequency: 1000 Hz; Amplitude: 1 Vp; Modulation: Off.

In this example, the measured Audio SINAD is 73.189 dB.

Making Measurements
Audio SINAD Measurement

4 Front-Panel Key and SCPI Command Reference

This chapter provides detailed descriptions of the front-panel keys and the associated SCPI commands and screens used to set up and make Measuring Receiver measurements.

4.1 Programming Command Compatibility Across Model Numbers and Across Modes

4.1.1 Across PSA Modes: Command Subsystem Similarities

When you select different modes you get different sets of available programming commands. That is, *only* the commands that are appropriate for the current mode are available. Also, some commands have the same syntax in different modes but have different ranges or settings that are only appropriate to the current mode.

The following table shows which command subsystems are the same across different modes. If there is no “X” by a particular subsystem, then the set of available commands is different in those modes. Command ranges or defaults may also be different. Refer to the programming command descriptions in the documentation for each mode for details.

Command Subsystem	Same command set is available: SA mode compared with the application modes: Digital Modulation, Basic, WLAN, W-CDMA, cdmaOne, cdma2000, 1xEV-DO, GSM, EDGE, NADC, PDC, or Measuring Receiver	Same command set is available: SA mode compared with the application modes: Phase Noise, Noise Figure, TD-SCDMA
IEEE common commands	X	X
ABORt	X	X
CALCulate		
CALibration	X	X
CONFigure		
COUPle	not available in these application modes	not available in these application modes
DISPlay		
FETCh		
FORMat		X
HCOPy	X	X
INITiate		
INPut	not available in these application modes	X
MEASure		

Command Subsystem	Same command set is available: SA mode compared with the application modes: Digital Modulation, Basic, WLAN, W-CDMA, cdmaOne, cdma2000, 1xEV-DO, GSM, EDGE, NADC, PDC, or Measuring Receiver	Same command set is available: SA mode compared with the application modes: Phase Noise, Noise Figure, TD-SCDMA
MEMory	X	X
MMEMory	X	X
MMEMory:STORe:TRACe	not available in these application modes	X
READ		
[SENSe]		
[SENSe:]CHANnel		
[SENSe:]CORRection		
[SENSe:]FEED		
[SENSe:]FREQuency:CE NTer	X	
[SENSe:]FREQuency:<other subsystems>	not available in these application modes	not available in these application modes
[SENSe:]<measurement>		
[SENSe:]POWer		
[SENSe:]RADio		
[SENSe:]SYNC		
STATus	X	X
SYSTem	X	X
TRACe	not available in these application modes	X
TRIGger		
UNIT	X	X

Front-Panel Key and SCPI Command Reference

4.1.2 Across PSA Modes: Specific Command Differences

Some programming commands operate differently depending on which Mode the analyzer is set to.

Command	Spectrum Analysis, Phase Noise and Noise Figure Mode	Basic, cdmaOne, cdma2000, 1xEV-DO, W-CDMA, GSM, EDGE, NADC, PDC Modes
CONFigure: <measurement>	Accesses the measurement and sets the instrument settings to the defaults. Averaging is turned on and set to 10. The instrument is put in single measurement mode. It does not initiate a measurement. Use INIT:IMM to make one measurement.	Accesses the measurement and sets the instrument settings to the defaults. If you were already in single measurement mode, it takes one measurement and then waits. If you were in continuous measurement mode it continues to measure.
*ESE default	Default is 255 which means that every error/status bit change that has occurred will be returned with a *ESR? query. You must set the value of *ESE to choose only the bits/status that you want returned.	Default is 0 which means that none of the error/status bit changes that have occurred will be returned with a *ESR? query. You must set the value of *ESE to choose the bits/status that you want returned.
TRIGger commands	For these modes, only one trigger source can be selected and it will be common across the modes. Also, only one value can be set for the trigger delay, level, or polarity.	For these modes, a unique trigger source can be selected for each mode. Also, each trigger source can have unique settings for the its delay, level, and polarity.
Saving and recalling traces	Traces can only be saved when in the Spectrum Analysis mode (MMEM:STOR:TRAC). This is because the instrument state must be saved along with the trace data and the state data varies depending on the number of modes currently available in the instrument.	

4.1.3 Using Applications in PSA Series vs. VSA E4406A

NOTE This information *only* applies to the application modes:
 Basic, cdmaOne, cdma2000, 1xEV-DO, W-CDMA, GSM, EDGE,
 NADC, and PDC.

Command	PSA Series	VSA E4406A: A.04.00	VSA E4406A: A.05.00
*RST	Resets instrument, putting it in continuous measurement mode. Use INIT:CONT OFF to select single measurement mode and INIT:IMM to start one measurement.	Resets instrument, putting it in single measurement mode. One measurement is initiated when the command is sent.	Resets instrument, putting it in single measurement mode. No measurement is initiated when the command is sent. Use INIT:IMM to start one measurement.
CONFigure: <measurement>	Accesses the measurement and sets the instrument settings to the defaults. If you were already in single measurement mode, it takes one measurement and then waits.	Same as PSA. Accesses the measurement and sets the instrument settings to the defaults. If you were already in single measurement mode, it takes one measurement and then waits.	Accesses the measurement and sets the instrument settings to the defaults. If you were already in single measurement mode, it does not initiate a measurement. Use INIT:IMM to make one measurement.
*ESE default	Default is 255 which means that every error/status bit change that has occurred will be returned with a *ESR? query. You must set the value of *ESE to choose only the bits/status that you want returned.	Default is 0 which means that none of the error/status bit changes that have occurred will be returned with a *ESR? query. You must set the value of *ESE to choose the bits/status that you want returned.	Same as VSA A.04.00. Default is 0 which means that none of the error/status bit changes that have occurred will be returned with a *ESR? query. You must set the value of *ESE to choose the bits/status that you want returned.
*LRN	The command is <i>not</i> available.	The command is available.	The command is available.

Front-Panel Key and SCPI Command Reference

Command	PSA Series	VSA E4406A: A.04.00	VSA E4406A: A.05.00
TRIGger commands	<p>In Spectrum Analysis mode only one value can be set for the trigger's source, delay, level, or polarity.</p> <p>Basic, GSM, EDGE, cdmaOne, cdma2000, W-CDMA, NADC, PDC modes function the same as VSA</p>	<p>You can select a unique trigger source for each mode. Each trigger source can have unique settings for the its delay, level, and polarity.</p>	<p>Same as VSA A.04.00.</p> <p>You can select a unique trigger source for each mode. Each trigger source can have unique settings for the its delay, level, and polarity.</p>
AUTO ON OFF control and setting manual values	<p>We recommend that you set a function's automatic state to OFF, before you send it your manual value.</p> <p>Some functions will turn off the automatic mode when you send a specific manual value, but others will not. This also varies with the instrument model.</p>	<p>We recommend that you set a function's automatic state to OFF, before you send it your manual value.</p> <p>Some functions will turn off the automatic mode when you send a specific manual value, but others will not. This also varies with the instrument model.</p>	<p>We recommend that you set a function's automatic state to OFF, before you send it your manual value.</p> <p>Some functions will turn off the automatic mode when you send a specific manual value, but others will not. This also varies with the instrument model.</p>

4.2 Front-Panel Keys

NOTE Only front panel keys affected by selection of Measuring Receiver mode are described here. For a complete description of all front panel keys see the *PSA Series User's Guide*.

4.2.1 Det/Demod

Accesses all menus that enables to change settings on detectors and demodulation filters.

4.2.1.1 Detector

Sets the type of detectors.

Mode:	MRECEIVE
Key Path:	Det/Demod
Remote Command:	[:SENSe] :MRECeive:DETEctor PPEak NPEak PNPeak RMS [:SENSe] :MRECeive:DETEctor?
Preset:	PPEak
State Saved:	Saved in instrument state.
Range:	Peak + Peak - Peak + -/2 RMS
Dependencies/Couplings:	When current measurement is one of the four Audio measurements., the only available selection is RMS.
Remote Command Notes:	Global to the current mode.
Example:	MREC:DET PPE MREC:DET?

4.2.1.1.1 Peak Hold Turns on/off the Peak Hold mode.

Mode:	MRECEIVE
Key Path:	Det/Demod, Detector
Remote Command:	[:SENSe] :MRECeive:PHOLd ON OFF 0 1 [:SENSe] :MRECeive:PHOLd?
Preset:	OFF
State Saved:	Saved in instrument state.
Range:	On Off
Dependencies/Couplings:	This key is grayed out when the selected Detector is not either Peak + or Peak -. In this case, the Peak Hold switch is forced to be OFF.
Remote Command Notes:	Global to the current mode.
Example:	MREC:PHOL ON MREC:PHOL?

4.2.1.2 FM De-Emphasis

Sets the types of de-emphasis filters.

Mode:	MRECEIVE
Key Path:	Det/Demod
Remote Command:	[:SENSe] :MRECeive:DEEMphasis OFF T25 T50 T75 T750 [:SENSe] :MRECeive:DEEMphasis?
Preset:	OFF
State Saved:	Saved in instrument state.
Range:	None 25 us 50 us 75 us 750 us
Dependencies/Couplings:	This key is only available when Modulation Mode is set to FM or the current measurement is one of the Audio measurements.
Remote Command Notes:	Global to the current mode.
Example:	MREC:DEEM T25 MREC:DEEM?

4.2.1.3 High Pass Filter

Sets the type of high pass filters used by the instrument. The frequency indicated is the low frequency cut-off.

Mode:	MRECEIVE
Key Path:	Det/Demod
Remote Command:	<code>[:SENSe] :MRECeive :HPFilter OFF F50 F300</code> <code>[:SENSe] :MRECeive :HPFilter?</code>
Preset:	OFF
State Saved:	Saved in instrument state.
Range:	None (<20 Hz) 50 Hz 300 Hz
Dependencies/Couplings:	For Audio measurements the None (<20 Hz) key will be displayed as None, because the spec of Audio HW is from 20 Hz to 250 kHz.
Remote Command Notes:	Global to the current mode.
Example:	MREC:HPF F50 MREC:HPF?

4.2.1.4 Low Pass Filter

Sets the type of low pass filters used by the instrument. The frequency indicated is the high frequency cut-off.

Mode:	MRECEIVE
Key Path:	Det/Demod
Remote Command:	<code>[:SENSe] :MRECeive :LPFilter OFF F3K F15K F30K F300K</code> <code>[:SENSe] :MRECeive :LPFilter?</code>
Preset:	OFF
State Saved:	Saved in instrument state.
Range:	None (>300 kHz) 3 kHz 15 kHz 30 kHz 300 kHz
Dependencies/Couplings:	For Audio measurements, the 300 kHz choice is disabled, because the cutoff frequency of FIR LP filter in FPGA of Audio HW is 275 kHz. For Audio measurements the None (>300 kHz) key will be displayed as None.
Remote Command Notes:	Global to the current mode.
Example:	MREC:LPF F3K MREC:LPF?

4.2.1.5 Modulation Mode

Sets the types of analog modulation.

Mode:	MRECEIVE
Key Path:	Det/Demod
Remote Command:	[:SENSE] :MRECEIVE :MODULATION :TYPE AM FM PM [:SENSE] :MRECEIVE :MODULATION :TYPE ?
Preset:	AM
State Saved:	Saved in instrument state.
Range:	AM FM PM
Dependencies/Couplings:	This key is grayed out when current measurement is one of the four Audio measurements. If the current measurement is AM/FM/PM, the value must be AM/FM/PM and can not be modified.
Remote Command Notes:	Global to the current mode.
Example:	MREC:MOD:TYPE FM MREC:MOD:TYPE ?

4.2.2 Power Meter

Accesses the menus for setting and performing calibrations for PSA and power meter.

4.2.2.1 Calibrate Power Meter

Calibrates the power meter.

Mode:	MRECEIVE
Key Path:	System, More, More, Power Meter
Remote Command:	:CALIBRATION:PMETER:CALIBRATE
Dependencies/Couplings:	This key is grayed out when current measurement is one of the four Audio measurements.
Remote Command Notes:	Global to the current mode.
Example:	:CAL:PMET:CAL

4.2.2.2 Calibrate Power Meter State

Gets the state of power meter after being calibrated.

Mode: MRECEIVE
Remote Command: :CALibration:PMETer:CALibrate:STAT?
 Remote Command Notes: Global to the current mode.
 Example: :CAL:PMET:CAL:STAT?

4.2.2.3 Power Meter Configuration

Accesses the menu to configure connection with power meter. This key is grayed out when current measurement is one of the four Audio measurements.

4.2.2.3.1 Channel Sets the channel for the specified hardware.

Mode: MRECEIVE
 Key Path: **System, More, More, Power Meter, Power Meter Config**
Remote Command: :SYSTem:COMMunicate:PMETer:CHANnel:SElect A|B
 :SYSTem:COMMunicate:PMETer:CHANnel:SElect?
 Preset: A
 State Saved: Saved in instrument state.
 Range: A | B
 Dependencies/Couplings: Please refer to the note.
 Remote Command Notes: Global to the current mode.
 Example: :SYST:COMM:PMET:CHAN:SEL B
 :SYST:COMM:PMET:CHAN:SEL?

4.2.2.3.2 Connection Mode Sets the way that the PSA is connected with the power meter.

Mode:	MRECEIVE
Key Path:	System, More, More, Power Meter, Power Meter Config
Remote Command:	:SYSTem:COMMunicate:PMETer:CONNecTion LAN LG :SYSTem:COMMunicate:PMETer:CONNecTion?
Preset:	LAN
State Saved:	Saved in instrument state.
Range:	LAN LAN/GPIB Gateway
Remote Command Notes:	Global to the current mode.
Example:	:SYST:COMM:PMET:CONN LG :SYST:COMM:PMET:CONN?

4.2.2.3.3 IP Address To input the IP address set in the power meter or GPIB/LAN Gateway.

Mode:	MRECEIVE
Key Path:	System, More, More, Power Meter, Power Meter Config
Remote Command:	:SYSTem:COMMunicate:PMETer:IP <string> :SYSTem:COMMunicate:PMETer:IP?
Preset:	10.10.10.10
State Saved:	Saved in instrument state.
Remote Command Notes:	Global to the current mode.
Example:	:SYST:COMM:PMET:IP 10.10.10.10 :SYST:COMM:PMET:IP?

4.2.2.3.4 Model No. Returns the model number of the power meter.

Mode:	MRECEIVE
Remote Command:	:SYSTem:COMMunicate:PMETer:MODEl?
Preset:	[NONE]
State Saved:	Saved in instrument state.
Remote Command Notes:	Global to the current mode.
Example:	:SYST:COMM:PMET:MOD?

4.2.2.3.5 Power Meter GPIB Address Sets the GPIB address of the power meter.

Mode: MRECEIVE

Key Path: **System, More, More, Power Meter, Power Meter Config**

Remote Command: :SYSTem:COMMunicate:PMETer:GPIB:ADDRess <integer>
 :SYSTem:COMMunicate:PMETer:GPIB:ADDRess?

Range: 1 to 30

Preset: 13

State Saved: Saved in instrument state.

Remote Command Notes: Global to the current mode.

Example: :SYST:COMM:PMET:GPIB:ADDR 18
 :SYST:COMM:PMET:GPIB:ADDR?

4.2.2.3.6 Power Meter Firmware Version Returns the firmware version of the power meter connected.

Mode: MRECEIVE

Remote Command: :SYSTem:COMMunicate:PMETer:FW:VERSion?

Preset: [NONE]

State Saved: No

Remote Command Notes: Query Only

Example: SYST:COMM:PMET:FW:VERS?

4.2.2.3.7 Power Meter Logical Unit Sets the Logical Unit for the power meter.

Mode: MRECEIVE

Remote Command: :SYSTem:COMMunicate:PMETer:GPIB:LOGical:UNIT
 :SYSTem:COMMunicate:PMETer:GPIB:LOGical:UNIT?

Remote Command Notes: Global to the current mode.

Example: SYST:COMM:PMET:GPIB:LOG:UNIT 7
 SYST:COMM:PMET:GPIB:LOG:UNIT?

4.2.2.3.8 Power Meter Options Returns the options installed in the power meter.

Mode: MRECEIVE

Remote Command: :SYSTem:COMMunicate:PMETer:OPTions?

Preset: [NONE]

State Saved: No

Remote Command Notes: Query Only

Example: SYST:COMM:PMET:OPT?

4.2.2.3.9 Resolution Sets and Gets the resolution of the power meter.

Mode: MRECEIVE

Key Path: **System, More, More, Power Meter, Power Meter Config, More**

Remote Command: :SYSTem:COMMunicate:PMETer:RESolution D001|D01
:SYSTem:COMMunicate:PMETer:RESolution?

Range: 0.01dB|0.001dB

Preset: D01

State Saved: Saved in instrument state.

Remote Command Notes: Global to the current mode.

Example: :SYST:COMM:PMET:RES D01
:SYST:COMM:PMET:RES?

4.2.2.3.10 Serial No. Returns the serial number of the power meter.

Mode: MRECEIVE

Remote Command: :SYSTem:COMMunicate:PMETer:SNUMber?

Preset: [NONE]

State Saved: Saved in instrument state.

Remote Command Notes: Global to the current mode.

Example: :SYST:COMM:PMET:SNUM?

4.2.2.3.11 Show Setup Display the current configuration information for the power meter.

Mode: MRECEIVE
 Dependencies/Couplings: Enabled only when the power meter is available.
 Key Path: **System, More, More, Power Meter, Power Meter Config**

4.2.2.3.12 Time Out Sets and Gets the time-out time for connecting the power meter in units of seconds and milliseconds.

Mode: MRECEIVE
 Key Path: **System, More, More, Power Meter, Power Meter Config, More**
Remote Command: :SYSTem:COMMunicate:PMETer:TCONnect:TOUT <time>
 :SYSTem:COMMunicate:PMETer:TCONnect:TOUT?
 Unit: s | ms
 Range: 1.0s to 120.0s
 Preset: 10.0s
 State Saved: Saved in instrument state.
 Remote Command Notes: Global to the current mode.
 Example: :SYST:COMM:PMET:TCON:TOUT 18
 :SYST:COMM:PMET:TCON:TOUT?

4.2.2.3.13 Verify Power Meter Connection Tests the Connection from the PSA to the power meter.

Mode: MRECEIVE
 Key Path: **System, More, More, Power Meter, Power Meter Config**
Remote Command: :SYSTem:COMMunicate:PMETer:TCONnect
 Remote Command Notes: Global to the current mode.
 Example: MREC:PMET:TCON

4.2.2.3.14 Verify Power Meter Connection State Gets the state of the connection to the power meter.

Mode: MRECEIVE
Remote Command: :SYSTem:COMMunicate:PMETer:TCONnect:STATe?
 Remote Command Notes: Global to the current mode.
 Example: :SYST:COMM:PMET:TCON:STAT?

4.2.2.4 Power Meter Needs Calibration

Check whether the power meter needs calibration or not.

Mode: MRECEIVE
Remote Command: :CALibration:PMETer:NCAL?
 Remote Command Notes: Global to the current mode.
 Example: :CAL:PMET:NCAL?

4.2.2.5 Power Meter Needs Zero

Check whether the power meter needs zero or not.

Mode: MRECEIVE
Remote Command: :CALibration:PMETer:NZERo?
 Remote Command Notes: Global to the current mode.
 Example: :CAL:PMET:NZER?

4.2.2.6 Zero & Cal Power Meter

Resets & Calibrates the power meter.

Mode: MRECEIVE
 Key Path: **System, More, More, Power Meter**
Remote Command: :CALibration:PMETer:ZCALibrate
 Dependencies/Couplings: This key is grayed out when current measurement is one of the four Audio measurements.
 Remote Command Notes: Global to the current mode.
 Example: :CAL:PMET:ZCAL

4.2.2.7 Zero & Calibrate Power Meter State

Gets the state of power meter after being zeroed & calibrated.

Mode: MRECEIVE
Remote Command: :CALibration:PMETer:ZCALibrate:STATe?
 Remote Command Notes: Global to the current mode.
 Example: :CAL:PMET:ZCAL:STAT?

4.2.2.8 Zero Power Meter

Resets the power meter.

Mode: MRECEIVE
 Key Path: **System, More, More, Power Meter**
Remote Command: :CALibration:PMETer:ZERO
 Dependencies/Couplings: This key is grayed out when current measurement is one of the four Audio measurements.
 Remote Command Notes: Global to the current mode.
 Example: :CAL:PMET:ZERO

4.2.2.9 Zero Power Meter State

Gets the state of power meter after being zeroed.

Mode: MRECEIVE
Remote Command: :CALibration:PMETer:ZERO:STATe?
 Remote Command Notes: Global to the current mode.
 Example: :CAL:PMET:ZERO:STAT?

4.2.3 Power Sensor

Accesses the menu for power sensor configurations. This key is grayed out when current measurement is one of the four Audio measurements: Audio Frequency, Audio AC Level, Audio Distortion and Audio SINAD.

When the PSA is powered-on, the retained data will be displayed.

4.2.3.1 Add New Points

Adds new points.

Mode:	MRECEIVE
Remote Command:	:SYSTem:CFACtor:NPS <real>,<real>{,<real>,<real>}
Preset:	1e9, 100
State Saved:	No
Remote Command Notes:	Command Only
Example:	:SYSTem:CFAC:NPS 1.5e9,98.876,1.34e6,92.34562,100,87.3

4.2.3.2 Calibration Due Date

Sets the Calibration Due date of the sensor

Mode:	MRECEIVE
Key Path:	System, Power Sensor Config
Remote Command:	:SYSTem:PSENSor:DDATE <Integer> :SYSTem:PSENSor:DDATE?
Preset:	20000101
State Saved:	Saved in instrument state.
Min:	19000101
Max:	99991231
Example:	:SYSTem:PSEN:DDAT 20120803 :SYSTem:PSEN:DDAT?

4.2.3.3 Calibration Due Date String

Gets the Calibration Due date of the sensor in the type of string

Mode: MRECEIVE
Remote Command: :SYSTem:PSENSor:DDATE:STRing?
 Preset: 20050101 00:00:00 AM
 State Saved: Saved in instrument state.
 Example: :SYSTem:PSEN:DDAT:STR?

4.2.3.4 Clear Power Sensor

Clear all the information, including the cal factors, of the Power Sensor.

Mode: MRECEIVE
 Key Path: **System, Power Sensor Config, More**
Remote Command: :SYSTem:PSENSor:CLR
 Remote Command Notes: Global to the current mode.
 Example: SYST:PSEN:CLR

4.2.3.5 Delete All Points

Deletes all points.

Mode: MRECEIVE
 Key Path: **System, Power Sensor Config, Cal Factor**
Remote Command: :SYSTem:CFACTOR:DALL
 Key Path: **Mode Setup, Calibration, Power Sensor, Cal Factor Edit**
 Notes: There will be a pop up message to ask user to confirm deletion by pressing this key again.
 Example: :SYSTem:CFAC:DALL

4.2.3.6 Edit Cal Factors

Accesses the editor that is used to show and edit the power sensor calibration factors.

4.2.3.6.1 Cal Factor Sets the calibration factor of the current point.

Mode:	MRECEIVE
Key Path:	System, Power Sensor Config, Cal Factors, Cal Factor Edit
Preset:	0.0
State Saved:	Saved in instrument state.
Min:	0.0
Max:	100.0

4.2.3.6.2 Delete Point Deletes the current highlighted point.

Mode:	MRECEIVE
Key Path:	System, Power Sensor Config, Cal Factors, Cal Factor Edit
Notes:	There will be a pop up message to ask user to confirm deletion by pressing this key again.

4.2.3.6.3 Frequency Sets the frequency of the current point.

Mode:	MRECEIVE
Key Path:	System, Power Sensor Config, Cal Factors, Cal Factor Edit
Unit:	Hz kHz MHz GHz
Preset:	30.0
State Saved:	Saved in instrument state.
Min:	1 Hz
Max:	40 GHz

4.2.3.6.4 Point Selects the point or adds a new point.

Mode:	MRECEIVE
Key Path:	System, Power Sensor Config, Cal Factors, Cal Factor Edit
Preset:	1
State Saved:	Saved in instrument state.
Min:	1
Max:	1000

4.2.3.7 Model Number

Sets the model number of the sensor

Mode:	MRECEIVE
Key Path:	System, Power Sensor Config
Remote Command:	:SYSTem: PSENSor: MNUMBER <string> :SYSTem: PSENSor: MNUMBER?
Preset:	[NONE]
Remote Command Notes:	Global to the current mode.
Example:	:SYSTem: PSEN: MNUM "N5532A" :SYSTem: PSEN: MNUM?

4.2.3.8 Option

Sets the option of the sensor

Mode:	MRECEIVE
Key Path:	System, Power Sensor Config
Remote Command:	:SYSTem: PSENSor: OPTion <string> :SYSTem: PSENSor: OPTion?
Preset:	[NONE]
Remote Command Notes:	Global to the current mode.
Example:	MREC: PSEN: OPT "518" MREC: PSEN: OPT?

4.2.3.9 Recall Power-On Default

Recall the default power-on values of the Power Sensor.

Mode:	MRECEIVE
Key Path:	System, Power Sensor Config, More
Remote Command:	:SYSTem: PSENSor: RECDefault
Remote Command Notes:	Global to the current mode.
Example:	SYST: PSEN: RECD

4.2.3.10 Reference CF

Displays the reference CF of the sensor.

Mode:	MRECEIVE
Key Path:	System, Power Sensor Config
Remote Command:	:SYSTem:PSENSor:RCF <real> :SYSTem:PSENSor:RCF?
Preset:	100.0
State Saved:	Saved in instrument state.
Min:	0.0
Max:	100.0
Remote Command Notes:	Global to the current mode.
Example:	:SYSTem:PSEN:RCF 99 :SYSTem:PSEN:RCF?

4.2.3.11 Reset All Points

Resets all points.

Mode:	MRECEIVE
Remote Command:	:SYSTem:CFACTOR:RST <real>,<real>{,<real>,<real>}
Preset:	1e9, 100
State Saved:	No
Remote Command Notes:	Command Only
Example:	:SYSTem:CFAC:RST 1.5e9,98.876,1.34e6,92.34562,100,87.3

4.2.3.12 Serial Number

Sets the serial number of the sensor

Mode:	MRECEIVE
Key Path:	System, Power Sensor Config
Remote Command:	:SYSTem: PSENSor: SNUMber <string> :SYSTem: PSENSor: SNUMber?
Preset:	[NONE]
Remote Command Notes:	Global to the current mode.
Example:	:SYSTem: PSEN: SNUM "US0000000" :SYSTem: PSEN: SNUM?

4.2.3.13 Update Power-On Default

Keeps the current Power Sensor information as the default power-on values.

Mode:	MRECEIVE
Key Path:	System, Power Sensor Config, More
Remote Command:	:SYSTem: PSENSor: UDEFault
Remote Command Notes:	Global to the current mode.
Example:	SYST: PSEN: UDEF

4.2.4 FREQUENCY/Channel

Displays the menu of frequency functions.

4.2.4.1 Center Frequency

Sets the center frequency to be measured. This key is invalid when the measurement is Frequency Counter, RF Power and one of the four Audio measurements.

Mode:	MRECEIVE
Key Path:	FREQUENCY/Channel
Remote Command:	[:SENSe] :FREQuency:CENTer <freq> [:SENSe] :FREQuency:CENTer?
Unit:	Hz kHz MHz GHz
Preset:	1.0 GHz
State Saved:	Saved in instrument state.
Range:	Hardware dependent, see Table 4-1, “Ranges of Center Frequency,” on page 142
Dependencies/Couplings:	None.
Remote Command Notes:	Global to the current mode.

Table 4-1 Ranges of Center Frequency

Model Number	Range of Center Frequency
E4440A	3 Hz to 26.5 GHz
E4443A	3 Hz to 6.7 GHz
E4445A	3 Hz to 13.2 GHz
E4446A	3 Hz to 44 GHz
E4447A	3 Hz to 42.98 GHz
E4448A	3 Hz to 50 GHz

4.2.5 Input

This key provides the same behavior as that of Input key of the other options except the options for Input Port. Under Mode Setup menu, parameters can be changed via using the Form.

4.2.5.1 Input Port

This key provides the same behavior as that of Input Port key of the other options except new options for “Audio” and “Audio Calibrator”.

Mode:	MRECEIVE
Key Path:	Input, Input Port
Remote Command:	<code>[:SENSE] :FEED RF AREference AUDio AFAlign</code> <code>[:SENSE] :FEED?</code>
Preset:	RF
State Saved:	Saved in instrument state.
Range:	RF Amptd Ref Audio AF Calibrator
Dependencies/Couplings:	The AF and AF Calibrator keys are blank when opt. 107 is not installed.
Remote Command Notes:	Global to the current mode.
Example:	<code>:FEED Audio</code> <code>:FEED?</code>

4.2.5.2 Ext Atten

Sets the loss equal to the external attenuation used when measuring the device under test.

Mode:	MRECEIVE
Key Path:	Input, Ext Atten
Remote Command:	<code>[:SENSE] :CORRection [:RF] :LOSS <rel_power></code> <code>[:SENSE] :CORRection [:RF] :LOSS?</code>
Preset:	0 dB
State Saved:	Saved in instrument state.
Range:	- 50 to +50 dB
Remote Command Notes:	You must be in the Basic mode to use this command. Use INSTRument:SElect to set the mode. Value is global to Basic mode.
Example:	<code>POW:RF:GAIN ON</code> <code>POW:RF:GAIN?</code>

4.2.5.3 Int Preamp

Sets the state of the Internal Preamplifier.

Mode:	MRECEIVE
Key Path:	Input, Internal Preamplifier
Remote Command:	[:SENSE] :POWER:RF:GAIN [:STATE] ON OFF 0 1 [:SENSE] :POWER:RF:GAIN [:STATE] ?
Preset:	OFF
State Saved:	Saved in instrument state.
Range:	On Off
Remote Command Notes:	Global to the current mode.
Example:	POW:RF:GAIN ON POW:RF:GAIN?

4.2.5.4 Microwave Preselector

Sets the state of the Microwave Preselector.

Mode:	MRECEIVE
Key Path:	Input, Microwave Preselector
Remote Command:	[:SENSE] :POWER:RF:MW:PRESelector [:STATE] ON OFF 0 1 [:SENSE] :POWER:RF:MW:PRESelector [:STATE] ?
Preset:	ON
State Saved:	Saved in instrument state.
Range:	On Off
Notes:	This key is grayed out when center frequency \leq 3.05 GHz, and the state will always be ON.
Remote Command Notes:	Global to the current mode.
Example:	POW:RF:MW:PRES ON POW:RF:MW:PRES?

4.2.5.5 RF Input Ranging

Sets the power input range of the PSA.

Mode:	MRECEIVE
Key Path:	Input, RF Input Ranging

Remote Command:	<code>[:SENSE] :MRECEive:RAUTo OFF ON 0 1</code> <code>[:SENSE] :MRECEive:RAUTo?</code>
Preset:	OFF
State Saved:	Saved in instrument state.
Dependencies/Couplings:	This key is grayed out when current measurement is one of the four Audio measurements.
Remote Command Notes:	Global to the current mode.
Example:	MREC:RAUT ON MREC:RAUT?

4.2.5.6 Input Atten

Sets the value of the input attenuation.

Mode:	MRECEIVE
Key Path:	Input, Input Attenuation
Remote Command:	<code>[:SENSE] :POWER:RF:ATTenuation <integer></code> <code>[:SENSE] :POWER:RF:ATTenuation?</code>
Unit:	dB
Preset:	0
State Saved:	Saved in instrument state.
Min:	0 dB
Max:	70 dB
Remote Command Notes:	Global to the current mode.
Example:	POW:RF:ATT 30 POW:RF:ATT?

4.2.5.7 Ext Audio Attenuation

Sets the value of the external Audio attenuation.

Mode:	MRECEIVE
Key Path:	Input, More, Ext Audio Attenuation
Remote Command:	<code>[:SENSE] :MRECEive:AUDio:ATTenuation <real></code> <code>[:SENSE] :MRECEive:AUDio:ATTenuation?</code>

Front-Panel Keys

Unit:	dB
Preset:	0
State Saved:	Saved in instrument state.
Min:	-50.0 dB
Max:	100.0 dB
Remote Command	Global to the current mode.
Notes:	
Example:	:MREC:AUD:ATT 30 :MREC:AUD:ATT?

4.2.5.8 Ext RF Attenuation

Sets the value of the external RF input attenuation.

Mode:	MRECEIVE
Key Path:	Input
Remote Command:	[:SENSE] :CORREction[:RF] :LOSS <integer> [:SENSE] :CORREction[:RF] :LOSS?
Unit:	dB
Preset:	0
State Saved:	Saved in instrument state.
Min:	-50.0 dB
Max:	100.0 dB
Remote Command	Global to the current mode.
Notes:	
Example:	:CORR:LOSS 10 :CORR:LOSS?

4.2.5.9 Audio Ranging

Sets the measurement range of the Audio Input (option 107) if available.

Mode:	MRECEIVE
Key Path:	Input, More

Remote Command: [:SENSe]:MRECeive:ARANge R0|R1|R2|R3|R4
[:SENSe]:MRECeive:ARANge?

Preset: R0

State Saved: Saved in instrument state.

Range: Range 0 | Range 1 | Range 2 | Range 3 | Range 4, See “[Table of Audio Ranges](#)” on page 147.

Dependencies/Couplings: This key is grayed out, when option 107 is not available or the input port is set to RF.

Remote Command Notes: Global to the current mode.

Example: :MREC:ARAN R1
:MREC:ARAN?

Table 4-2 Table of Audio Ranges

Audio Range	Current Range	
	Lowest (Vrms)	Highest (Vrms)
0	1.5	3.0
1	0.75	1.5
2	0.375	0.75
3	0.1875	0.375
4	0.1	0.1875

4.2.6 Meas Control

These functions allow you to pause and resume the currently selected measurement and to select between continuous or single measurements.

4.2.6.1 Measure

Press this key to toggle the measurement state between **Single** and **Cont** (continuous). **NOTE:** This key has a different function than the **MEASURE** front panel key. When set to **Single**, the measurement will continue until it has reached the specified number of averages set by the average counter. When set to **Cont**, the measurement will run continuously and execute averaging according to the current average mode, either repeat or exponential.

Key Path	Meas Control
Factory Preset	Cont
State Saved	Saved in instrument state.
Remote Command	:INITiate:CONTinuous OFF ON
Remote Command Notes	<p>When ON, at the completion of each trigger cycle, the trigger system immediately initiates another trigger cycle.</p> <p>When OFF, the trigger system remains in an “idle” state until CONTinuous is set to ON or an :INITiate[:IMMediate] command is received. On receiving the :INITiate[:IMMediate] command, it will go through a single trigger cycle, and then return to the “idle” state.</p> <p>The query INIT:CONT? returns 1 or 0. 1 is returned when the instrument is continuous triggering. 0 is returned when it is single triggering.</p>
Example	:INIT:CONT OFF

4.2.6.2 Pause/Resume

Press this key to pause the current measurement until you reactivate the measurement. Once toggled, the label of the **Pause** key changes to read **Resume**. The **Resume** key, once pressed, continues the active measurement from the point at which it was paused.

Key Path:	Meas Control
Remote Command:	No equivalent command.

4.2.6.3 Restart

Press this key to repeat the current measurement from the beginning, while retaining the current measurement settings. This is equivalent to the **Restart** front panel key.

Key Path:	Meas Control
Remote Command:	No equivalent command.
Remote Command Notes:	This could be done by sending an :ABORt command followed by an:INITiate[:IMMediate] command.

4.2.7 Mode

Accesses any installed personality modes. The minimum set of available modes will be Spectrum Analysis and Measuring Receiver. This menu will have additional entries if other personalities have been installed, for example GSM/EDGE Option 202 or cdmaOne Option BAC.

4.2.7.1 Spectrum Analysis

For information related to the operation of the Spectrum Analysis mode refer to the *PSA User's/Programmer's Guide*.

4.2.7.2 Measuring Receiver

The Measuring Receiver mode provides you the ability to set up your own measurement environment to measure RF frequency, RF power and tuned RF level, and analyze AM/FM/PM and audio signals.

4.2.7.2.1 Instrument Selection by Name (Remote command only) Selects the measurement mode. The actual available choices depend upon which modes (measurement applications) are installed in the instrument. A list of the valid choices is returned with the INST:CAT? query.

Remote Command	:INSTrument [:SElect] SA PNOISE BASIC CDMA CDMA2K EDGEgSM NADC PDC WCDMA CDMA1XEV NFIGURE WLAN MRECEIVE :INSTrument [:SElect] ?
Example	:INST MRECEIVE :INST?
Key Path	Mode

Once an instrument mode is selected, only the commands that are valid for that mode can be executed.

NOTE If you are using the status bits and the analyzer mode is changed, the status bits should be read, and any errors resolved, prior to switching modes. Error conditions that exist prior to switching modes cannot be detected using the condition registers after the mode change. This is true unless they recur after the mode change, although transitions of these conditions can be detected using the event registers.

Changing modes resets all SCPI status registers and mask registers to their power-on defaults. Hence, any event or condition register masks must be re-established after a mode change. Also note that the power up status bit is set by any mode change, since that is the default state after power up.

4.2.7.2.2 Instrument Selection by Number (Remote command only) Selects the measurement mode by its instrument number. The actual available choices depends upon which applications are installed in the instrument.

- 1 = SA (PSA/ESA)
- 3 = GSM (GSM on E4406A, and GSM or GSM w/EDGE on ESA)
- 4 = CDMA (cdmaOne) (E4406/ESA/PSA)
- 5 = NADC (E4406/PSA)
- 6 = PDC (E4406/PSA)
- 8 = BASIC (E4406/PSA)
- 9 = WCDMA (3GPP W-CDMA with HSDPA/HSUPA) (E4406/PSA)
- 10 = CDMA2K (cdma2000 with 1xEV-DV) (E4406/PSA)
- 13 = EDGE GSM (E4406/PSA)
- 14 = PNOISE (phase noise) (ESA/PSA)
- 15 = CMDA1XEV (1xEV-D0) (E4406/PSA)
- 211 = TDSCDMA (PSA)
- 241 = DMODULATION (PSA)
- 217 = WLAN (PSA)
- 219 = NOISEFIGURE (ESA/PSA)
- 233 = MRECEIVE (PSA)

Remote Command :INSTrument:NSElect 233
 :INSTrument:NSElect?

Example :INST:NSEL 233
 :INST:NSEL?

Key Path **Mode**

4.2.8 Save/Load File Operations

4.2.8.1 Save

Saves the calibration factor information to a file. When access by front panel, the type of the file should be set to Calibration first. And if necessary, the directory and the file name can also be set.

Mode: MRECEIVE
 Key Path: **File, Save**
Remote Command: :MMEMory:STORe:PSCFactor <'file_name'>
 Remote Command Global to the current mode.
 Notes:
 Example: MMEMory:STORe:PSCF 'C:\PSCF0001.XML'

4.2.8.2 Load

Loads the calibration factor information from a file to the calibration factor editor. When access by front panel, the type of the file should be set to Calibration first. And if necessary, the directory and the file name can also be set.

Mode: MRECEIVE
 Key Path: **File, Load**
Remote Command: :MMEMory:LOAD:PSCFactor <'file_name'>
 Remote Command Global to the current mode.
 Notes:
 Example: MMEMory:LOAD:PSCF 'C:\PSCF0001.XML'

NOTE Most of the SCPI command for the calibrate factors file operations is consistent with those in the MMEMory subsystem, for example, Catalog, Delete, etc., except for Save and Load.

4.3 Measure

Accesses the Measure menus.

4.3.1 Command Interactions: MEASure, CONFigure, FETCh, INITiate and READ

Figure 4-1 Measurement Group of Commands

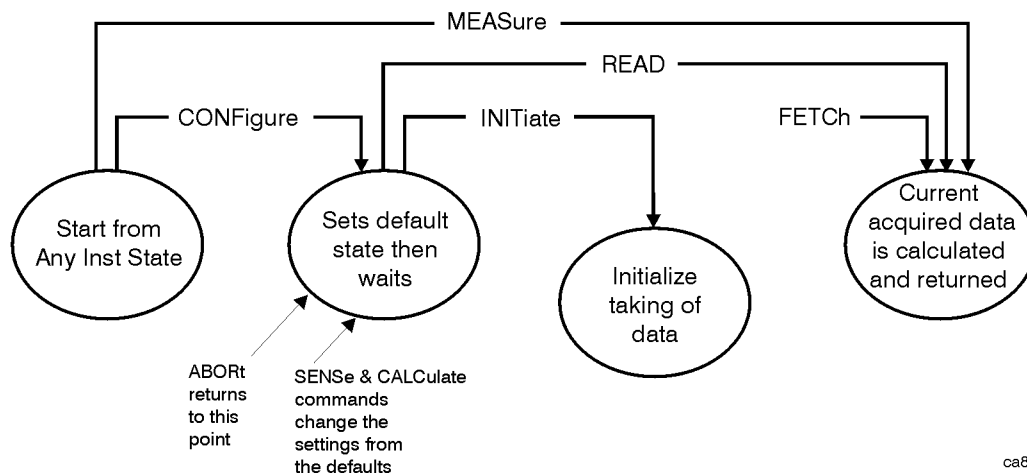

Measure Commands:

:MEASure:<measurement> [n] ?

This is a fast single-command way to make a measurement using the factory default instrument settings. These are the settings and units that conform to the Mode Setup settings (that is, radio standard) that you have currently selected.

- Stops the current measurement (if any) and sets up the instrument for the specified measurement using the factory defaults
- Initiates the data acquisition for the measurement
- Blocks other SCPI communication, waiting until the measurement is complete before returning results.
- After the data is valid it returns the scalar results, or the trace data, for the specified measurement. The type of data returned may be defined by an [n] value that is sent with the command.

The scalar measurement results will be returned if the optional [n] value is not included, or is set to 1. If the [n] value is set to a value other than 1, the selected trace data results will be returned. See each command for details of what types of scalar results or trace data results are available.

ASCII is the default format for the data output. (Older versions of Spectrum Analysis and Phase Noise mode measurements only use ASCII.) The binary data formats should be used for handling large blocks of data since they are smaller and faster than the ASCII format. Refer to the FORMat:DATA command for more information.

If you need to change some of the measurement parameters from the factory default settings you can set up the measurement with the CONFigure command. Use the commands in the SENSE:<measurement> and CALCulate:<measurement> subsystems to change the settings. Then you can use the READ? command to initiate the measurement and query the results. See [Figure 4-1](#).

If you need to repeatedly make a given measurement with settings other than the factory defaults, you can use the commands in the SENSE:<measurement> and CALCulate:<measurement> subsystems to set up the measurement. Then use the READ? command to initiate the measurement and query results.

Measurement settings persist if you initiate a different measurement and then return to a previous one. Use READ:<measurement>? if you want to use those persistent settings. If you want to go back to the default settings, use MEASure:<measurement>?.

Configure Commands:

:CONFigure:<measurement>

This command stops the current measurement (if any) and sets up the instrument for the specified measurement using the factory default instrument settings. It sets the instrument to single measurement mode but should not initiate the taking of measurement data unless INIT:CONTinuous is ON. After you change any measurement settings, the READ command can be used to initiate a measurement without changing the settings back to their defaults.

The CONFigure? query returns the current measurement name.

Fetch Commands:

:FETCh:<measurement> [n] ?

This command puts selected data from the most recent measurement into the output buffer. Use FETCh if you have already made a good measurement and you want to return several types of data (different [n] values, that is both scalars and trace data) from a single measurement. FETCh saves you the time of re-making the measurement. You can only FETCh results from the measurement that is currently active, it will not change to a different measurement.

If you need to get new measurement data, use the READ command, which is equivalent to an INITiate followed by a FETCh.

The scalar measurement results will be returned if the optional [n] value is not included, or is set to 1. If the [n] value is set to a value other than 1, the selected trace data results will be returned. See each command for details of what types of scalar results or trace data results are available. The binary data formats should be used for handling large blocks of data since they are smaller and transfer faster than the ASCII format. (FORMat:DATA)

FETCh may be used to return results other than those specified with the original READ or MEASure command that you sent.

INITiate Commands:

:INITiate:<measurement>

This command is not available for measurements in all the instrument modes:

- Initiates a trigger cycle for the specified measurement, but does not output any data. You must then use the FETCh<meas> command to return data. If a measurement other than the current one is specified, the instrument will switch to that measurement and then initiate it.
For example, suppose you have previously initiated the ACP measurement, but now you are running the channel power measurement. If you send INIT:ACP? it will change from channel power to ACP and will initiate an ACP measurement.
- Does not change any of the measurement settings. For example, if you have previously started the ACP measurement and you send INIT:ACP? it will initiate a new ACP measurement using the same instrument settings as the last time ACP was run.
- If your selected measurement is currently active (in the idle state) it triggers the measurement, assuming the trigger conditions are met. Then it completes one trigger cycle. Depending upon the measurement and the number of averages, there may be multiple data acquisitions, with multiple trigger events, for one full trigger cycle. It also holds off additional commands on GPIB until the acquisition is complete.

READ Commands:

:READ:<measurement> [n] ?

- Does not preset the measurement to the factory default settings. For example, if you have previously initiated the ACP measurement and you send READ:ACP? it will initiate a new measurement using the same instrument settings.
- Initiates the measurement and puts valid data into the output buffer. If a measurement other than the current one is specified, the instrument will switch to that measurement before it initiates the measurement and returns results.

For example, suppose you have previously initiated the ACP measurement, but now you are running the channel power measurement. Then you send READ:ACP? It will change from channel power back to ACP and, using the previous ACP settings, will initiate the measurement and return results.

- Blocks other SCPI communication, waiting until the measurement is complete before returning the results

If the optional [n] value is not included, or is set to 1, the scalar measurement results will be returned. If the [n] value is set to a value other than 1, the selected trace data results will be returned. See each command for details of what types of scalar results or trace data results are available. The binary data formats should be used when handling large blocks of data since they are smaller and faster than the ASCII format. (FORMat:DATA)

4.3.2 Frequency Counter

Allows the user to switch to the Frequency Counter measurement.

Mode: MRECEIVE
 Key Path: Measure
Remote Command: :CONFigure:FCOUNTER
 Notes: This key invokes Frequency Counter Measurement
 Example: :CONF:FCO

4.3.2.1 SCPI Remote Commands

:CONFigure:FCOUNTER
 :INITiate:FCOUNTER
 :FETCh:FCOUNTER [n] ?
 :MEASure:FCOUNTER [n] ?
 :READ:FCOUNTER [n] ?

Index: n <Mnemonic >	Results Returned
not specified or n = 1	Returns the following 4 values: Frequency (Hz) Frequency error (when set to Manual tune mode, 0 in Auto Tuning Mode) Ratio Reference Frequency (Hz) (-999 in Normal mode, depends on Display Mode setting) Frequency Ratio (-999 in Normal mode, Ratio: dB or % depending on Ratio Mode setting) <hr/> NOTE If you are using the ASCII data output format, you will not get the same number of significant digits in the returned value as shown on the display. You must select one of the binary block data formats. (See FORMat:TRACe:DATA) <hr/>

4.3.3 RF Power

Allows the user to switch to the RF Power measurement.

Mode: MRECEIVE
 Key Path: **Measure**
Remote Command: :CONFigure:RFPower
 Notes: This key invokes RF Power Measurement.
 Example: :CONF:RFP

4.3.3.1 SCPI Remote Commands

:CONFigure:RFPower
 :INITiate:RFPower
 :FETCh:RFPower [n] ?
 :MEASure:RFPower [n] ?
 :READ:RFPower [n] ?

Index: n <Mnemonic >	Results Returned
not specified or n = 1	Returns the following 4 values: RF Power (dBm, Watt or Volt depending on the Display Unit setting) RF Power Reference RF Power (–999 in Normal mode, depends on Display Mode setting) Relative RF Power (–999 in Normal mode , dB/%, depends on Ratio Mode setting) RF Frequency (Hz) Cal Factor (% , the Cal Factor is the value queried from the Cal Factor table according to the Carrier Frequency)

4.3.4 Tuned RF Level

Allows the user to switch to the Tuned RF Level measurement.

Mode:	MRECEIVE
Key Path:	Measure
Remote Command:	:CONFigure:TRFLevel
Notes:	This key invokes Tuned RF Level Measurement.
Example:	:CONF:TRFL

4.3.4.1 SCPI Remote Commands

- :CONFigure:TRFLevel
- :INITiate:TRFLevel
- :FETCh:TRFLevel [n] ?
- :MEASure:TRFLevel [n] ?
- :READ:TRFLevel [n] ?

NOTE Offsets that are turned off (inactive) will return -999.0 when their results are queried over SCPI.

Index: n <Mnemonic >	Results Returned
not specified or n = 1	Returns the following 7 values: Absolute Tuned RF level (dBm, Watt or Volt, depending on setting of Display Unit) Absolute Tuned RF Level Ratio (dB/%) (-999.0 if Display Mode is Normal) Absolute Tuned RF Level Ratio Reference (dBm, Watt or Volt, depending on setting of Display Unit) Relative Tuned RF Level (dB)(-999.0 if it is absolute measurement) Relative Tuned RF Level Reference (dBm)(-999.0 if it is absolute measurement) Frequency This is the value from Frequency counter measurement

4.3.5 AM Depth

Allows the user to switch to AM Depth measurement.

Mode: MRECEIVE
 Key Path: **Measure**
Remote Command: :CONFigure:AMDepth
 Notes: This key invokes AM Depth Measurement.
 Example: :CONF:AMD

4.3.5.1 SCPI Remote Commands

:CONFigure:AMDepth
 :INITiate:AMDepth
 :FETCh:AMDepth [n] ?
 :MEASure:AMDepth [n] ?
 :READ:AMDepth [n] ?

Index: n <Mnemonic>	Results Returned
0	Returns unprocessed I/Q trace data, as a series of comma-separated trace points, in volts. The I values are listed first in each pair, using the 0 through even-indexed values. The Q values are the odd-indexed values.
not specified or n = 1	Returns comma-separated scalar results, in the following order: AM Depth (% or dB, depending on setting of Display Unit) AM Depth Ratio (–999 in Normal mode, Ratio: dB or % depending on Ratio Mode setting) Ratio Reference Depth (dB or % depending on Display Units) Modulation Rate (Hz) Modulation Distortion (%) Modulation SINAD (dB)
2	Return demodulated waveform vs. time data, as a series of comma-separated trace points. The result is a series of real numbers in percents.

4.3.6 FM Deviation

Allows the user to switch to the FM Deviation measurement.

- Mode: MRECEIVE
- Key Path: **Measure**
- Remote Command:** :CONFigure:FMDeviation
- Notes: This key invokes FM Deviation Measurement.
- Example: :CONF:FMD

4.3.6.1 SCPI Remote Commands

- :CONFigure:FMDeviation
- :INITiate:FMDeviation
- :FETCh:FMDeviation [n] ?
- :MEASure:FMDeviation [n] ?
- :READ:FMDeviation [n] ?

Index: n <Mnemonic>	Results Returned
0	Returns unprocessed I/Q trace data, as a series of comma-separated trace points, in volts. The I values are listed first in each pair, using the 0 through even-indexed values. The Q values are the odd-indexed values.
not specified or n = 1	Returns comma-separated scalar results, in the following order: FM Deviation (Hz) FM Deviation Ratio (-999 in Normal mode, Ratio: dB or % depending on Ratio Mode setting) FM Ratio Reference Deviation (Hz) Modulation Rate (Hz) Modulation Distortion (%) Modulation SINAD (dB)
2	Return demodulated waveform vs. time data, as a series of comma-separated trace points. The result is a series of real numbers in Hz.

4.3.7 PM Deviation

Allows the user to switch to the PM Deviation measurement.

Mode: MRECEIVE
 Key Path: **Measure**
Remote Command: :CONFigure:PMDeviation
 Notes: This key invokes PM Deviation Measurement.
 Example: :CONF:PMD

4.3.7.1 SCPI Remote Commands

:CONFigure:PMDeviation
 :INITiate:PMDeviation
 :FETCh:PMDeviation [n] ?
 :MEASure:PMDeviation [n] ?
 :READ:PMDeviation [n] ?

Index: n <Mnemonic>	Results Returned
0	Returns unprocessed I/Q trace data, as a series of comma-separated trace points, in volts. The I values are listed first in each pair, using the 0 through even-indexed values. The Q values are the odd-indexed values.
not specified or n = 1	Returns comma-separated scalar results, in the following order: PM Deviation (rad or deg, depending on the setting of Display Unit) PM Deviation Ratio (–999 in Normal mode, Ratio: dB or % depending on Ratio Mode setting) PM Ratio Reference Deviation (rad or deg, depending on the setting of Display Unit) Modulation Rate (Hz) Modulation Distortion (%) Modulation SINAD (dB)
2	Return demodulated waveform vs. time data, as a series of comma-separated trace points. The result is a series of real numbers in Rad

4.3.8 Modulation Rate

Allows the user to switch to the Modulation Rate measurement.

Mode: MRECEIVE
 Key Path: **Measure, More**
Remote Command: :CONFigure:MODRate
 Notes: This key invokes Modulation Rate Measurement.
 Example: :CONF:MODR

4.3.8.1 SCPI Remote Commands

:CONFigure:MODRate
 :INITiate:MODRate
 :FETCh:MODRate [n] ?
 :MEASure:MODRate [n] ?
 :READ:MODRate [n] ?

Index: n <Mnemonic >	Results Returned
0	Returns unprocessed I/Q trace data, as a series of comma-separated trace points, in volts. The I values are listed first in each pair, using the 0 through even-indexed values. The Q values are the odd-indexed values.
not specified or n = 1	Returns comma-separated scalar results, in the following order: Return the measured modulation rate (Hz). Modulation Rate Ratio (–999 in Normal mode, Ratio: dB or % depending on Ratio Mode setting) Ratio Reference Frequency (Hz) Return demodulated result(% for AM, Hz for FM, and rad for PM) Return modulation distortion(%) Return modulation sinad(dB)

4.3.9 Modulation Distortion

Allows the user to switch to the Modulation Distortion measurement.

Mode: MRECEIVE
 Key Path: **Measure, More**
Remote Command: :CONFigure:MODDist
 Notes: This key invokes Modulation Distortion Measurement.
 Example: :CONF:MODD

4.3.9.1 SCPI Remote Commands

```
:CONFigure:MODDist
:INITiate:MODDist
:FETCh:MODDist [n] ?
:MEASure:MODDist [n] ?
:READ:MODDist [n] ?
```

Index: n <Mnemonic>	Results Returned
0	Returns unprocessed I/Q trace data, as a series of comma-separated trace points, in volts. The I values are listed first in each pair, using the 0 through even-indexed values. The Q values are the odd-indexed values.
not specified or n = 1	Returns comma-separated scalar results, in the following order: Return Modulation Distortion (dB or % depending on Display Units) Return Modulation Distortion Ratio(–999.0 in Normal mode; in Ratio mode, dB or % depending on Ratio Mode setting) Ratio Reference Distortion (dB or % depending on Display Units) Return Modulation Sinad(dB)

4.3.10 Modulation SINAD

Allows the user to switch to the Modulation SINAD measurement.

- Mode: MRECEIVE
- Key Path: **Measure, More**
- Remote Command:** :CONFigure:MODSinad
- Notes: This key invokes Modulation SINAD Measurement.
- Example: :CONF:MODS

4.3.10.1 SCPI Remote Commands

- :CONFigure:MODSinad
- :INITiate:MODSinad
- :FETCh:MODSinad [n] ?
- :MEASure:MODSinad [n] ?
- :READ:MODSinad [n] ?

Index: n <Mnemonic>	Results Returned
0	Returns unprocessed I/Q trace data, as a series of comma-separated trace points, in volts. The I values are listed first in each pair, using the 0 through even-indexed values. The Q values are the odd-indexed values.
not specified or n = 1	Returns comma-separated scalar results, in the following order: Return Modulation SINAD (dB or % depending on Display Units) Return Modulation SINAD Ratio(-999.0 in Normal mode; in Ratio mode, dB or % depending on Ratio Mode setting) Ratio Reference SINAD (dB or % depending on Display Units) Return Modulation Distortion(%)

4.3.11 Audio Frequency

Allows the user to switch to the Audio Frequency measurement.

- Mode: MRECEIVE
- Key Path: **Measure, More**
- Remote Command:** :CONFigure:AUDFreq
- Dependencies/Couplings: This key is grayed out when opt 107 is not available.
- Notes: This key invokes Audio Frequency Measurement.
- Example: :CONF:AUDF

4.3.11.1 SCPI Remote Commands

- :CONFigure:AUDFreq
- :INITiate:AUDFreq
- :FETCh:AUDFreq [n] ?
- :MEASure:AUDFreq [n] ?
- :READ:AUDFreq [n] ?

Index: n <Mnemonic >	Results Returned
0	Returns unprocessed real trace data, as a series of comma-separated trace points, in volts.
not specified or n = 1	Returns comma-separated scalar results, in the following order: Return the measured audio frequency (Hz) Audio Frequency Ratio (–999 in Normal mode, Ratio: dB or % depending on Ratio Mode setting) Ratio Reference Frequency (Hz)

4.3.12 Audio AC Level

Allows the user to switch to the Audio Level measurement.

- Mode: MRECEIVE
- Key Path: **Measure, More**
- Remote Command:** :CONFigure:AUDLevel
- Dependencies/Couplings: This key is grayed out when opt 107 is not available.
- Notes: This key invokes Audio AC Level measurement.
- Example: :CONF:AUDL

4.3.12.1 SCPI Remote Commands

- :CONFigure:AUDLevel
- :INITiate:AUDLevel
- :FETCh:AUDLevel [n] ?
- :MEASure:AUDLevel [n] ?
- :READ:AUDLevel [n] ?

Index: n <Mnemonic >	Results Returned
0	Returns unprocessed real data.
not specified or n = 1	Returns comma-separated scalar results, in the following order: Return the audio AC level(V) Return the audio AC level Ratio(−999 in Normal mode, Ratio: dB or % depending on Ratio Mode setting) Ratio Reference Level (V) Return the audio frequency(Hz) Return the audio distortion(%) Return the audio sinad(dB)

4.3.13 Audio Distortion

Allows the user to switch to the Audio Distortion measurement.

Mode: MRECEIVE
 Key Path: **Measure, More**
Remote Command: :CONFigure:AUDDist
 Dependencies/Couplings: This key is grayed out when opt 107 is not available.
 Notes: This key invokes Audio Distortion Measurement.
 Example: :CONF:AUDD

4.3.13.1 SCPI Remote Commands

```
:CONFigure:AUDDist
:INITiate:AUDDist
:FETCh:AUDDist [n] ?
:MEASure:AUDDist [n] ?
:READ:AUDDist [n] ?
```

Index: n <Mnemonic >	Results Returned
0	Returns unprocessed real trace data, as a series of comma-separated trace points, in volts.
not specified or n = 1	Returns comma-separated scalar results, in the following order: Return Audio Distortion (dB or % depending on Display Units) Return Audio Distortion Ratio(-999.0 in Normal mode; in Ratio mode, dB or % depending on Ratio Mode setting) Ratio Reference Distortion (dB or % depending on Display Units) Return Audio Sinad(dB)
2	Return Spectrum of Audio signal.

4.3.14 Audio SINAD

Allows the user to switch to the Audio SINAD measurement.

- Mode: MRECEIVE
- Key Path: **Measure, More, More**
- Remote Command:** :CONFigure:AUDSinad
- Dependencies/Couplings: This key is grayed out when opt 107 is not available.
- Notes: This key invokes Audio SINAD Measurement.
- Example: :CONF:AUDS

4.3.14.1 SCPI Remote Commands

- :CONFigure:AUDSinad
- :INITiate:AUDSinad
- :FETCh:AUDSinad [n] ?
- :MEASure:AUDSinad [n] ?
- :READ:AUDSinad [n] ?

Index: n <Mnemonic >	Results Returned
0	Returns unprocessed real trace data, as a series of comma-separated trace points, in volts.
not specified or n = 1	Returns comma-separated scalar results, in the following order: Return Audio SINAD (dB or % depending on Display Units) Return Audio SINAD Ratio(−999.0 in Normal mode; in Ratio mode, dB or % depending on Ratio Mode setting) Ratio Reference SINAD (dB or % depending on Display Units) Return Audio Distortion(%)

4.4 Measurement keys

4.4.1 Frequency Counter Measurement

There is only one view available for Frequency Counter measurement. There are two windows:

- Frequency Counter Numeric Results Window (upper)
- Frequency Counter Settings Window (lower)

See following tables for each window display:

Table 4-3 Frequency Counter Numeric Results Window

Name	Corresponding Results
RF Frequency	n=1, 1st when Display mode is Normal
RF Freq Error	n=1, 2nd It can only be displayed when tuning mode is Manual
RF Freq Ratio	n=1, 3rd when Display mode is Ratio This result will replace the Frequency when Display Mode is Ratio

Table 4-4 Frequency Counter Settings Window

Name	Corresponding Results
Tuning Mode	It can be Auto or Manual.
Tuning Frequency	It is the value of Manual Tuning Frequency
Reference	It can be Int or Ext for the Frequency Reference
Freq Ref	It is value of the reference frequency. For Int, it is 10 MHz. For ext, it can be 1 MHz ~ 30 MHz.
Gate Mode	It can be Auto or Manual
Gate Time	It is the value of Gate Time
RBW	It is the value of Resolution BW

4.4.1.1 AMPLITUDE/Y Scale

The AMPLITUDE/Y Scale key accesses the menu to set the desired vertical scale and associated settings:

NOTE Default setting numbers are independent for each window.

When you select Frequency Counter Settings Window and press AMPLITUDE/Y Scale key, a blank Y Scale menu will display.

4.4.1.1.1 Display Mode Sets the display mode.

Mode: MRECEIVE

Key Path: **Amplitude/Y Scale**

Remote Command: :DISPlay:FCOunter:MODE NORMal|RATio
:DISPlay:FCOunter:MODE?

Preset: NORMal

State Saved: Saved in instrument state.

Range: Normal | Ratio

Dependencies/Couplings: No

Example: :DISP:FCO:MODE NORM
:DISP:FCO:MODE?

4.4.1.1.2 Display Unit Sets the unit for Normal display mode.

Mode: MRECEIVE

Key Path: **Amplitude/Y Scale**

Remote Command: :DISPlay:FCOunter:UNIT HZ|KHZ|MHZ|GHZ
:DISPlay:FCOunter:UNIT?

Preset: HZ

State Saved: Saved in instrument state.

Range: Hz | kHz | MHz | GHz

Example: :DISP:FCO:UNIT GHZ
:DISP:FCO:UNIT?

4.4.1.1.3 Ratio Reference If Frequency need to be displayed relative to a reference, enter the value as a frequency ratio reference using this key.

Mode:	MRECEIVE
Key Path:	Amplitude/Y Scale
Remote Command:	:DISPlay:FCOunter:RREFerence <freq> :DISPlay:FCOunter:RREFerence? :DISPlay:FCOunter:RREFerence:AUTO 0 1 OFF ON :DISPlay:FCOunter:RREFerence:AUTO?
Unit:	Hz kHz MHz GHz
Preset:	1.0 GHz
State Saved:	Saved in instrument state.
Min:	1 Hz
Max:	Hardware dependent on the PSA specified model number
Dependencies/Couplings:	No
Example:	:DISP:FCO:RREF 500 MHz :DISP:FCO:RREF? :DISP:FCO:RREF:AUTO OFF :DISP:FCO:RREF:AUTO?

4.4.1.1.4 Ratio Mode The ratio and previous ratio functions permit any measurement result to be scaled to a reference. The reference may be either a measurement result or a keyboard entry. The Log/Linear key enables measurement results to be displayed in linear or logarithmic units.

Mode:	MRECEIVE
Key Path:	Amplitude/Y Scale
Remote Command:	:DISPlay:FCOunter:RMODe LOG LINear :DISPlay:FCOunter:RMODe?
Preset:	LOG
State Saved:	Saved in instrument state.
Range:	Log Linear
Dependencies/Couplings:	No
Example:	:DISP:FCO:RMOD LOG :DISP:FCO:RMOD?

4.4.1.2 Meas Setup

Accesses the Meas Setup menu.

4.4.1.2.1 Tuning Sets tuning mode and center frequency for manual tuning mode.

Mode:	MRECEIVE
Key Path:	Meas Setup
Remote Command:	[:SENSE] :FCOunter:TFrequency <freq> [:SENSe] :FCOunter:TFrequency? [:SENSe] :FCOunter:TAUTo 0 1 OFF ON [:SENSe] :FCOunter:TAUTo?
Unit:	Hz kHz MHz GHz
Preset:	1 GHz
State Saved:	Saved in instrument state.
Min:	100 kHz
Max:	Hardware dependent on the PSA specified model number
Example:	:FCO:TFR 100 MHz :FCO:TFR? :FCO:TAUT OFF :FCO:TAUT?

4.4.1.2.2 Gate Time Sets the gate time for frequency counter.

Mode:	MRECEIVE
Key Path:	Meas Setup
Remote Command:	[:SENSE] :FCOunter:GLENgtH <time> [:SENSe] :FCOunter:GLENgtH? [:SENSe] :FCOunter:GAUTo 0 1 OFF ON [:SENSe] :FCOunter:GAUTo?
Unit:	s ms us
Preset:	100.0ms
State Saved:	Saved in instrument state.
Min:	1us
Max:	500.0ms
Example:	:FCO:GLEN 200.0 ms :FCO:GLEN? :FCO:GAUT OFF :FCO:GAUT?

4.4.1.2.3 Avg Number Sets the number that will be averaged. After the specified number (average counts) have been averaged, the averaging mode (termination control) setting determines the averaging action.

Mode: MRECEIVE

Key Path: Meas Setup

Remote Command: [:SENSE]:FCOunter:AVERage:COUNT <integer>
[:SENSE]:FCOunter:AVERage:COUNT?
[:SENSe]:FCOunter:AVERage[:STATe] OFF|ON|0|1
[:SENSe]:FCOunter:AVERage[:STATe]?

Preset: 25, ON

State Saved: Saved in instrument state.

Min: 1

Max: 8192

Example: :FCO:AVER:COUN 10
:FCO:AVER:COUN?
:FCO:AVER:STAT OFF
:FCO:AVER:STAT?

4.4.1.2.4 Avg Mode Selects the type of termination control used for averaging. This determines the averaging action after the specified number of average count is reached.

- Repeat - After reaching the average count, the averaging is reset and a new average is started
- Exponential - Each successive result after the average count is reached, is exponentially weighted and combined with the existing average.

Mode: MRECEIVE

Key Path: Meas Setup

Remote Command: [:SENSE]:FCOunter:AVERage:TYPE REP|EXP
[:SENSe]:FCOunter:AVERage:TYPE?

Preset: REP

State Saved: Saved in instrument state.

Range: Repeat | Exponential

Example: :FCO:AVER:TYPE EXP
:FCO:AVER:TYPE?

4.4.1.2.5 RBW Selects the Resolution Bandwidth.

Mode:	MRECEIVE
Key Path:	Meas Setup
Remote Command:	[:SENSe] :FCOunter:RBW <freq> [:SENSe] :FCOunter:RBW?
Unit:	Hz kHz MHz
Preset:	1 kHz
State Saved:	Saved in instrument state.
Min:	1.0 Hz
Max:	3.0 MHz
Example:	:FCO:RBW 100 Hz :FCO:RBW?

4.4.2 RF Power Measurement

There is only one view available for RF Power measurement. There are two windows:

- RF Power Numeric Results Window (upper)
- RF Power Settings Window (lower)

Table 4-5 RF Power Numeric Results Window

Name	Corresponding Results
RF Power	n=1, 1st
Relative RF Power	n=2, 2nd This result will replace the RF Power when Display Mode is Ratio

Table 4-6 RF Power Setting Metrics Window

Name	Corresponding Results
Power Meter Model No.	Model No of the Power Meter
Power Meter Serial No.	Serial No of the Power Meter
Channel	Selected Channle of the Power Meter
Power Sensor Model No.	Model No of the Power Sensor
Power Sensor Serial No.	Serial No of the Power Sensor
Power Sensor Option	Option of the Power Sensor
Carrier Frequency	It is the value of carrier frequency measured by Frequency Counter measurement
Cal Factor	The Cal factor is the value retrieved from the Cal Factor file with the Carrier Frequency

4.4.2.1 AMPLITUDE/Y Scale

The AMPLITUDE/Y Scale key accesses the menu to set the desired vertical scale and associated settings.

4.4.2.1.1 Display Mode Sets the display mode.

Mode:	MRECEIVE
Key Path:	Amplitude/Y Scale
Remote Command:	:DISPlay:RFPower:MODE NORMAl RATio :DISPlay:RFPower:MODE?
Preset:	NORMAl
State Saved:	Saved in instrument state.
Range:	Normal Ratio
Example:	:DISP:RFP:MODE RAT :DISP:RFP:MODE?

4.4.2.1.2 Display Unit Sets the units for normal display mode.

Mode:	MRECEIVE
Key Path:	Amplitude/Y Scale
Remote Command:	:DISPlay:RFPower:UNIT DBM WATT V :DISPlay:RFPower:UNIT?
Preset:	DBM
State Saved:	Saved in instrument state.
Range:	dBm Watt V
Example:	:DISP:RFP:UNIT WATT :DISP:RFP:UNIT?

4.4.2.1.3 Ratio Reference If RF Power is to be displayed relative to a reference, enter the value as a ratio reference using this key.

Mode:	MRECEIVE
Key Path:	Amplitude/Y Scale
Remote Command:	:DISPlay:RFPower:RREference <real> :DISPlay:RFPower:RREference? :DISPlay:RFPower:RREference:AUTO 0 1 OFF ON :DISPlay:RFPower:RREference:AUTO?
Unit:	dBm
Preset:	0 dBm
State Saved:	Saved in instrument state.
Min:	-200 dBm
Max:	50 dBm
Dependencies/Couplings:	No
Example:	:DISP:POW:RREF -10 dBm :DISP:POW:RREF? :DISP:RFP:RREF:AUTO OFF :DISP:RFP:RREF:AUTO?

4.4.2.1.4 Ratio Mode

The ratio reference and ratio mode function permits measurement result to be scaled to a reference. The reference may be either a measurement result or a keyboard entry. The Log/Linear key enables measurement results to be displayed in linear or logarithmic units.

Mode:	MRECEIVE
Key Path:	Amplitude/Y Scale
Remote Command:	:DISPlay:RFPower:RMODe LOG LINear :DISPlay:RFPower:RMODe?
Preset:	LOG
State Saved:	Saved in instrument state.
Range:	Log Linear
Dependencies/Couplings:	No
Example:	:DISP:RFP:RMOD LOG :DISP:RFP:RMOD?

4.4.2.2 Meas Setup

Accesses the Meas Setup menu.

4.4.2.2.1 Avg Number Sets the number that will be averaged.

Mode:	MRECEIVE
Key Path:	Meas Setup
Remote Command:	[:SENSE] :RFPower:AVERage:COUNT <integer> [:SENSE] :RFPower:AVERage:COUNT? [:SENSE] :RFPower:AVERage [:STATE] OFF ON 0 1 [:SENSE] :RFPower:AVERage [:STATE] ?
Preset:	4, ON
State Saved:	Saved in instrument state.
Min:	1
Max:	1024
Example:	:RFP:AVER:COUN 10 :RFP:AVER:COUN? :RFP:AVER:STAT OFF :RFP:AVER:STAT?

4.4.2.2.2 Avg Mode Selects the type of termination control used for averaging. This determines the averaging action after the specified number of average count is reached.

- Repeat - After reaching the average count, the averaging is reset and a new average is started
- Exponential - Each successive result after the average count is reached, is exponentially weighted and combined with the existing average.

Mode:	MRECEIVE
Key Path:	Meas Setup
Remote Command:	[:SENSE] :RFPower:AVERage:TYPE REP EXP [:SENSE] :RFPower:AVERage:TYPE?
Preset:	REP
State Saved:	Saved in instrument state.
Range:	Repeat Exponential
Notes:	None
Example:	:RFP:AVER:TYPE EXP :RFP:AVER:TYPE?

4.4.2.2.3 Use Power Meter Selects whether an external power meter is used, if yes the RF RMS power is measured, else RF Peak power is measured.

Mode:	MRECEIVE
Key Path:	Mode Setup
<i>Remote Command:</i>	[:SENSe] :RFPower :PMETer :USE YES NO [:SENSe] :RFPower :PMETer :USE?
Preset:	YES
State Saved:	Saved in instrument state.
Range:	Yes no
Remote Command Notes:	Global to the current mode.
Example:	:RFP:PMET:USE NO :RFP:PMET:USE?

4.4.3 Tuned RF Level Measurement

There is only one view available for Tuned RF Level measurement. There are two windows:

- Tuned RF Level Numeric Results Window (upper)
- Measurement Settings window (lower)

Table 4-7 Tuned RF Level Measurement Result Window

Name	Corresponding Results
Tuned RF level	n=1 1st

Table 4-8 Tuned RF Level Setting Metrics Window

Name	Corresponding Results
IFBW	It is the value of IFBW
Display Mode	It can be Normal or Ratio
Ratio Reference	It is the reference value for Ratio mode
Ratio Mode	It can be Log or Linear
Carrier Frequency	It is the value of carrier frequency measured by Frequency Counter measurement
Cal Factor	The Cal factor is the value retrieved from the Cal Factor file with the Carrier Frequency
Range Hold	It can be On or Off
Range Switching Level	It is displayed when range switching is Man
Power Sensor	Sensor type

4.4.3.1 AMPLITUDE/Y Scale

The AMPLITUDE/Y Scale key accesses the menu to set the desired vertical scale and associated settings.

4.4.3.1.1 Display Mode Sets the display mode.

Mode:	MRECEIVE
Key Path:	Amplitude / Y Scale
Remote Command:	:DISPlay:TRFLevel:MODE NORMal RATio :DISPlay:TRFLevel:MODE?
Preset:	NORMal
State Saved:	Saved in instrument state.
Range:	Normal Ratio
Example:	DISP:TRFL:MODE NORM DISP:TRFL:MODE?

4.4.3.1.2 Display Unit Sets the unit for Normal display.

Mode:	MRECEIVE
Key Path:	Amplitude / Y Scale
Remote Command:	:DISPlay:TRFLevel:UNIT DBM WATT V :DISPlay:TRFLevel:UNIT?
Preset:	DBM
State Saved:	Saved in instrument state.
Range:	dBm Watt V
Example:	DISP:TRFL:UNIT DBM DISP:TRFL:UNIT?

4.4.3.1.3 Ratio Reference If the Tuned RF Level is to be displayed relative to a reference, enter the value as a ratio reference using this key.

Mode:	MRECEIVE
Key Path:	Amplitude / Y Scale
Remote Command:	:DISPlay:TRFLevel:RREference <real> :DISPlay:TRFLevel:RREference? :DISPlay:TRFLevel:RREference:AUTO 0 1 OFF ON :DISPlay:TRFLevel:RREference:AUTO?
Preset:	0dBm
State Saved:	Saved in instrument state.
Unit:	dBm
Min:	-150dBm
Max:	30dBm
Example:	DISP:TRFL:RREF 0.0 DISP:TRFL:RREF? :DISP:TRFL:RREF:AUTO OFF :DISP:TRFL:RREF:AUTO?

4.4.3.1.4 Ratio Mode

The ratio and previous ratio functions permit any measurement result to be scaled to a reference. The reference may be either a measurement result or a keyboard entry.

The Log/Linear key enables measurement results to be displayed in linear or logarithmic units, both absolute and relative. Examples of absolute units are kHz and mV (linear), or dBm (logarithmic). Examples of relative units are % and dB. When the instrument displays dB as a relative unit, the “REL” indicator is shown on the display.

Mode:	MRECEIVE
Key Path:	Display
Remote Command:	:DISPlay:TRFLevel:RMODe LOG LINear :DISPlay:TRFLevel:RMODe?
Preset:	LOG
State Saved:	Saved in instrument state.
Range:	Log Linear
Example:	DISP:TRFL:RMOD LOG DISP:TRFL:RMOD?

4.4.3.2 Meas Setup

Displays the measurement setup menu for the TRFL Measurement when the TRFLMeasurement key has been selected in the Measure menu.

4.4.3.2.1 Accuracy

This parameter is used to set average accuracy mode which can take effect on the actual average time used in this measurement. There are two modes that can be selected by user, they are Normal accuracy and High accuracy. The two modes can be explained as follows,

- Normal accuracy mode is the default state of this parameter. In this setting, the standard deviation of uncertainty of measurement level is set to 0.027 when SNR >30 dB or 0.1 when SNR <30 dB.
- High accuracy mode will set the standard deviation of uncertainty of measurement level as 0.027 when SNR >30 dB or SNR <30 dB.

Mode:	MRECEIVE
Key Path:	Meas Setup
Remote Command:	[:SENSE] :TRFLLevel :AVERage :ACCuracy NORM HIGH [:SENSE] :TRFLLevel :AVERage :ACCuracy?
Preset:	NORM
State Saved:	Saved in instrument state.
Range:	Normal High
Example:	:TRFL:AVER:ACC HIGH :TRFL:AVER:ACC?

4.4.3.2.2 IF BW

This parameter allows you to set IF BW. Only two options can be selected, 10 Hz or 75 Hz. 10Hz is the default setting and measures lower signal levels, but it can not tolerate poor residual FM noise from source. 75 Hz is better in tolerance of contrast in poor residual FM noise but it can measure signal level 8.75 dB higher than 10 Hz.

Key Path:	Meas Setup
Remote Command:	[:SENSE] :TRFLLevel :IFBW H10 H75 [:SENSE] :TRFLLevel :IFBW?
Preset:	H10
State Saved:	Saved in instrument state.
Range:	H10 H75
Example:	:TRFL:IFBW H10 :TRFL:IFBW?

4.4.3.2.3 Range Switching

Two kinds of range switching are supported. One is Manual ranging which is similar to what 8902A does. For example, when you use 0dBm and -60dBm signal to calibrate measuring receiver, while the signal is near 0dBm and -60dBm, recal status is displayed, then TRFL Calibrate key should be pressed. In Auto mode, the TRFL Calibrate key is grayed out, and the range switching can be made automatically depending on SNR.

Key Path:	Meas Setup
Remote Command:	<code>[:SENSe] :TRFLLevel:RASWitch AUTO MAN</code> <code>[:SENSe] :TRFLLevel:RASWitch?</code>
Preset:	AUTO
State Saved:	Saved in instrument state.
Range:	Auto Man
Dependencies/Couplings:	While Auto is selected, TRFL calibrated key must be grayed.
Example:	<code>:TRFL:RASW MAN</code> <code>:TRFL:RASW?</code>

4.4.3.2.4 Range Hold

In TRFL measurement, there are 2 ranges which may be used to measure over a range of >100 dB. This parameter forces the measurement to remain in the current range. One use for this parameter is when you are measuring unstable signals, which can cause the analyzer to switch between 2 different ranges. Selecting **RangeHold** holds the analyzer in the current range.

Mode:	MRECEIVE
Key Path:	Meas Setup
Remote Command:	<code>[:SENSe] :TRFLLevel:RHOLD OFF ON 0 1</code> <code>[:SENSe] :TRFLLevel:RHOLD?</code>
Preset:	OFF
State Saved:	Saved in instrument state.
Range:	On Off
Example:	<code>:TRFL:RHOL ON</code> <code>:TRFL:RHOL?</code>

4.4.3.2.5 TRFL Calibrate

Used to calibrate the Measurement Receiver while Recal status is displayed. Note, if Range Switching = Auto, this key will be unavailable in this case.

Mode:	MRECEIVE
Key Path:	Meas Setup
Remote Command:	[:SENSe] :TRFLLevel :CALibrate
Dependencies/Couplings:	This key will be grayed while Range Switching = AUTO
Example:	:TRFL:CAL

4.4.3.2.6 Set Ref

Used to make relative measurements such as attenuator measurement. When this key is pressed, the system is instructed to make a relative measurement, so the range1 initial power is not obtained from the power meter. The reference power is that power measured by PSA while the key is pressed.

NOTE If Set Ref key was previously pressed, the Amplitude/Y Scale menu is not available.

Mode:	MRECEIVE
Key Path:	Meas Setup
Remote Command:	[:SENSe] :TRFLLevel :SETRef
Dependencies/Couplings:	While this key is pressed, the menu under Display key is unavailable.
Example:	:TRFL:SETR

4.4.3.2.7 Range 3 Switch Delay

Adds a 5 minute delay when switching from Range 2 to Range 3. Range 3 turns on the internal preamplifier and this delay is necessary to allow the preamplifier to settle. When performing the Ranging Calibration, ensure that the Range 3 Switch Delay is ON for both the Ranging Calibration and the TRFL measurement routines, since you may perform the Ranging Calibration as a separate routine. However, you can take advantage of the fact that the Ranging Calibration will be triggered automatically (if the Range Switching is set to AUTO) as part of the TRFL measurement routine.

Mode:	MRECEIVE
Key Path:	Meas Setup
Remote Command:	<code>[:SENSe] :TRFLlevel :RDElay OFF ON 0 1 </code> <code>[:SENSe] :TRFLlevel :RDElay?</code>
Preset:	OFF
State Saved:	Saved in instrument state.
Example:	<code>:TRFL:RDEL ON</code> <code>:TRFL:RDEL?</code>

4.4.3.2.8 Range 1 cal factor

Indicates cal factor for range1.

Remote Command:	<code>:CALCulate:TRFLlevel:CAF1?</code>
Preset:	-999.0
State Saved:	Saved in instrument state.
Range:	-999dB to 999dB
Remote Command Notes:	Query Only
Example:	<code>:CALC:TRFL:CAF1?</code>

4.4.3.2.9 Range 2 cal factor

Indicates cal factor for range2.

Remote Command:	:CALCulate:TRFLevel:CAF2?
Preset:	-999.0
State Saved:	Saved in instrument state.
Range:	-999dB to 999dB
Remote Command Notes:	Query Only
Example:	:CALC:TRFL:CAF2?

4.4.3.2.10 Range 3 cal factor

Indicates cal factor for range3.

Remote Command:	:CALCulate:TRFLevel:CAF3?
Preset:	-999.0
State Saved:	Saved in instrument state.
Range:	-999dB to 999dB
Remote Command Notes:	Query Only
Example:	:CALC:TRFL:CAF3?

4.4.3.2.11 SNR

Indicates SNR measured by TRFL.

Remote Command:	:CALCulate:TRFLevel:SNR?
Preset:	-999.0
State Saved:	Saved in instrument state.
Range:	-999dB to 999dB
Remote Command Notes:	Query Only
Example:	:CALC:TRFL:SNR?

4.4.3.2.12 Range 2 switching point

Indicates range 2 switching point.

Remote Command:	:CALCulate:TRFLLevel:SPO1int?
Unit:	DBm
Preset:	-999.0dBm
State Saved:	Saved in instrument state.
Range:	-999dBm to 999dBm
Remote Command	Query Only
Notes:	
Example:	:CALC:TRFL:SPO1?

4.4.3.2.13 Range 3 switching point

Indicates range 3 switching point.

Remote Command:	:CALCulate:TRFLLevel:SPO2int?
Unit:	DBm
Preset:	-999.0dBm
State Saved:	Saved in instrument state.
Range:	-999dBm to 999dBm
Remote Command	Query Only
Notes:	
Example:	:CALC:TRFL:SPO2?

4.4.3.2.14 Store and Recall TRFL CalFactors

See [“Save/Load File Operations” on page 151.](#)

4.4.4 AM Depth Measurement

The AM Depth measurement consists of 2 views: Numeric Results View and Waveform View.

1. AM Depth Numeric Results View has two windows:

- AM Depth Numeric Results Window (upper)
- AM Depth Settings Window (lower)

Table 4-9 AM Depth Numeric Results Window

Name	Corresponding Results
AM Depth	n=1 1st AM depth output
Modulation Rate	n=1 3rd
Modulation Distortion	n=1 4th
Modulation SINAD	n=1 5th

Table 4-10 AM Depth Settings Window

Name	Corresponding Results
IF BW Type	It can be Auto, Manual or Min
IF BW	This value is the IF bandwidth set manually
Detector Selection	It can be Peak +, Peak -, Peak +/- 2 or RMS
Peak Hold	It can be On or Off
HP Filter	It can be None, 50 Hz or 300 Hz
LP Filter	It can be None, 3 kHz, 15 kHz, 30 kHz or 300 kHz

2. AM Depth Demod Waveform View has two windows:

- AM Depth Waveform Window (upper)
- AM Depth Numeric Results Window (lower)

Table 4-11 AM Depth Waveform Window

Marker Trace	Yes
Corresponding Trace	AM depth vs. Seconds trace (n=0)

Table 4-12 AM Depth Numeric Results Window

Name	Corresponding Results
AM Depth	n=1 1st AM depth output
Modulation Rate	n=1 3rd
Modulation Distortion	n=1 4th
Modulation SINAD	n=1 5th

4.4.4.1 SPAN/X Scale

The SPAN/X Scale key accesses the menu to set the desired horizon scale and associated settings of waveform.

4.4.4.1.1 Scale/Div This key is for Scale/Div control

Mode: MRECEIVE

Key Path: **Span X Scale**

Remote Command: :DISPlay:AMDepth[1] | 2:WINDow[1] | 2 | 3 | 4:TRACe:X[:SCALe]:PDI
Vision <seconds>

:DISPlay:AMDepth[1] | 2:WINDow[1] | 2 | 3 | 4:TRACe:X[:SCALe]:PDI
Vision?

Unit: Seconds

Preset: 100us

State Saved: Saved in instrument state.

Min: 1.0 ns

Max: 1 s

Dependencies/Couplings: See Restriction and Notes

Notes: If the Scale Coupling is set to On, this value is automatically determined by the measurement result. When you set this value manually, Scale Coupling automatically changes to Off.

Example: :DISP:AMD:WIND:TRAC:X:PDIV 100us
:DISP:AMD:WIND:TRAC:X:PDIV?

4.4.4.1.2 Ref Value Allows you to set the display reference.

Mode:	MRECEIVE
Key Path:	Span X Scale
Remote Command:	:DISPlay:AMDepth [1] 2 :WINDow [1] 2 3 4 :TRACe:X [:SCALe] :R LEVel <seconds> :DISPlay:AMDepth [1] 2 :WINDow [1] 2 3 4 :TRACe:X [:SCALe] :R LEVel?
Unit:	Seconds
Preset:	0.0
State Saved:	Saved in instrument state.
Min:	1 ns
Max:	10 s
Dependencies/Couplings:	See Restriction and Notes
Notes:	If the Scale Coupling is set to On, this value is automatically determined by the measurement result. When you set this value manually, Scale Coupling automatically changes to Off.
Example:	:DISP:AMD:WIND:TRAC:X:RLEV 0s :DISP:AMD:WIND:TRAC:X:RLEV?

4.4.4.1.3 Ref Position Allows you to set the display reference position to either Left, Ctr (center), or Right.

Mode:	MRECEIVE
Key Path:	Span X Scale
Remote Command:	:DISPlay:AMDepth [1] 2 :WINDow [1] 2 3 4 :TRACe:X [:SCALe] :RPOSition LEFT CENTer RIGHT :DISPlay:AMDepth [1] 2 :WINDow [1] 2 3 4 :TRACe:X [:SCALe] :RPOS ition?
Preset:	LEFT
State Saved:	Saved in instrument state.
Range:	Left Ctr Right
Example:	:DISP:AMD:WIND:TRAC:X:RPOS CENT :DISP:AMD:WIND:TRAC:X:RPOS?

4.4.4.1.4 Scale Coupling Allows you to toggle the scale coupling function between On and Off.

Mode:	MRECEIVE
Key Path:	Span X Scale
Remote Command:	:DISPlay:AMDepth[1] 2:WINDow[1] 2 3 4:TRACe:X[:SCALe]:COUPle 0 1 OFF ON :DISPlay:AMDepth[1] 2:WINDow[1] 2 3 4:TRACe:X[:SCALe]:COUPle?
Preset:	ON
State Saved:	Saved in instrument state.
Range:	Off On
Dependencies/Couplings:	See Restriction and Notes
Notes:	Upon pressing the Restart front-panel key or Restart softkey under the Meas Control menu, the scale coupling function automatically determines the scale per division and reference values based on the measurement results if this parameter is set to On. When you set a value to either Scale/Div or Ref Value manually, Scale Coupling automatically changes to Off.
Example:	:DISP:AMD:WIND:TRAC:X:COUP OFF :DISP:AMD:WIND:TRAC:X:COUP?

4.4.4.2 AMPLITUDE/Y Scale

The AMPLITUDE/Y Scale key accesses the menu to set the desired vertical scale and associated settings.

Default numbers are independent for each window.

4.4.4.2.1 AM Depth Numeric Results Window

If Numeric Result Window is chosen, the following menu is available.

4.4.4.2.1.1 Display Mode If measurement results are to be displayed relative to a reference, enter the value as a ratio reference by selecting **RATIO**.

Mode:	MRECEIVE
Key Path:	Amplitude Y Scale
Remote Command:	:DISPlay:AMDepth:MODE NORMal RATIo :DISPlay:AMDepth:MODE?
Preset:	NORMal
State Saved:	Saved in instrument state.
Range:	Normal Ratio
Example:	:DISP:AMD:MODE NORM :DISP:AMD:MODE?

4.4.4.2.1.2 Display Unit Sets the unit for Normal display.

Mode:	MRECEIVE
Key Path:	Amplitude Y Scale
Remote Command:	:DISPlay:AMDepth:UNIT PCT DB :DISPlay:AMDepth:UNIT?
Preset:	PCT
State Saved:	Saved in instrument state.
Range:	% dB
Example:	:DISP:AMD:UNIT PCT :DISP:AMD:UNIT?

4.4.4.2.1.3 Ratio Reference If AM depth is to be displayed relative to a reference, enter the value as a ratio reference using this key.

Mode:	MRECEIVE
Key Path:	Amplitude Y Scale
Remote Command:	:DISPlay:AMDepth:RREfERENCE <percent> :DISPlay:AMDepth:RREfERENCE? :DISPlay:AMDepth:RREfERENCE:AUTO 0 1 OFF ON :DISPlay:AMDepth:RREfERENCE:AUTO?
Preset:	100.00
State Saved:	Saved in instrument state.
Min:	0.01
Max:	100.00
Example:	:DISP:AMD:RREF 1.0 :DISP:AMD:RREF? :DISP:AMD:RREF:AUTO OFF :DISP:AMD:RREF:AUTO?

4.4.4.2.1.4 Ratio Mode The ratio and previous ratio functions permit any measurement result to be scaled to a reference. The reference may be either a measurement result or a keyboard entry. The Log/Linear key enables measurement results to be displayed in linear or logarithmic units. In the Ratio mode, measurements are made in the same way as when not in the Ratio mode. However, before the result is displayed, the internal controller converts it to ratio. The following equations are used for computing ratio:

$$(M/R) * 100 \% = \% \text{ ratio for linear display,}$$

$$20 * \log (M/R) = \text{dB ratio for logarithmic display,}$$

where M is the measurement result and R is the ratio reference.

Mode:	MRECEIVE
Key Path:	Amplitude Y Scale
Remote Command:	:DISPlay:AMDepth:RMODE LOG LINEar :DISPlay:AMDepth:RMODE?
Preset:	LOG
State Saved:	Saved in instrument state.
Range:	Log Linear
Example:	:DISP:AMD:RMOD LOG :DISP:AMD:RMOD?

4.4.4.2.2 AM Depth Waveform Window If the Demod Waveform Window is chosen, the following menu is available.

4.4.4.2.2.1 Scale/Div Allows you to enter a numeric value to change the vertical display sensitivity.

Mode:	MRECEIVE
Key Path:	Amplitude Y Scale
Remote Command:	:DISPlay:AMDepth [1] 2 :WINDow [1] 2 3 4 :TRACe:Y [:SCALe] :PDIV ision <percent> :DISPlay:AMDepth [1] 2 :WINDow [1] 2 3 4 :TRACe:Y [:SCALe] :PDIV ision?
Unit:	percent
Preset:	20
State Saved:	Saved in instrument state.
Range:	0.100 to 50.0
Dependencies/Couplings:	See Restriction and Notes
Notes:	If the Scale Coupling is set to On, this value is automatically determined by the measurement result. When you set this value manually, Scale Coupling automatically changes to Off.
Example:	:DISP:AMD:WIND:TRAC:Y:PDIV 20 :DISP:AMD:WIND:TRAC:Y:PDIV?

4.4.4.2.2.2 Ref Value Allows you to set the absolute power reference.

Mode:	MRECEIVE
Key Path:	Amplitude Y Scale
Remote Command:	:DISPlay:AMDepth [1] 2 :WINDow [1] 2 3 4 :TRACe:Y [:SCALe] :RLEV el <percent> :DISPlay:AMDepth [1] 2 :WINDow [1] 2 3 4 :TRACe:Y [:SCALe] :RLEV el?
Unit:	percent
Preset:	0.00
State Saved:	Saved in instrument state.
Min:	-500.0
Max:	500.0
Dependencies/Couplings:	See Restriction and Notes
Notes:	If the Scale Coupling is set to On, this value is automatically determined by the measurement result. When you set this value manually, Scale Coupling automatically changes to Off.

Measurement keys

Example: :DISP:AMD:WIND:TRAC:Y:RLEV 0
 :DISP:AMD:WIND:TRAC:Y:RLEV?

4.4.4.2.2.3 Ref Position Allows you to set the display reference position to either Top, Ctr (center), or Bot (Bottom).

Mode: MRECEIVE

Key Path: **Amplitude Y Scale**

Remote Command: :DISPlay:AMDepth [1] | 2:WINDow [1] | 2 | 3 | 4:TRACe:Y[:SCALE]
 :RPOSition TOP|CENTer|BOTTom
 :DISPlay:AMDepth [1] | 2:WINDow [1] | 2 | 3 | 4:TRACe:Y[:SCALE] :RPOS
 ition?

Preset: CENTer

State Saved: Saved in instrument state.

Range: Top | Ctr | Bottom

Example: :DISP:AMD:WIND:TRAC:Y:RPOS TOP
 :DISP:AMD:WIND:TRAC:Y:RPOS?

4.4.4.2.2.4 Scale Coupling Allows you to toggle the scale coupling function between On and Off.

Mode: MRECEIVE

Key Path: **Amplitude Y Scale**

Remote Command: :DISPlay:AMDepth [1] | 2:WINDow [1] | 2 | 3 | 4:TRACe:Y[:SCALE] :C
 OUPlE 0|1|OFF|ON
 :DISPlay:AMDepth [1] | 2:WINDow [1] | 2 | 3 | 4:TRACe:Y[:SCALE] :C
 OUPlE?

Preset: ON

State Saved: Saved in instrument state.

Range: On | Off

Dependencies/Couplings: See Restriction and Notes

Notes: Upon pressing the Restart front-panel key or Restart softkey under the Meas Control menu, the scale coupling function automatically determines the scale per division and reference values based on the measurement results if this parameter is set to On. When you set a value to either Scale/Div or Ref Value manually, Scale Coupling automatically changes to Off.

Example: :DISP:AMD:WIND:TRAC:Y:COUP OFF
 :DISP:AMD:WIND:TRAC:Y:COUP?

4.4.4.3 Trace / View

Allows you to select the desired measurement view from the following selections:

- Numeric Results
- Demod Waveform

Mode:	MRECEIVE
Key Path:	View/Display
Preset:	NUMeric
State Saved:	Saved in instrument state.
Range:	Numeric results Waveform result

4.4.4.4 Window Selection

Sets the active window.

Mode:	MRECEIVE
Remote Command:	:DISPlay:WINDow:SElect 1 2 :DISPlay:WINDow:SElect?
Preset:	1
State Saved:	No
Range:	1 2
Dependencies/Couplings:	Changing the selected window changes the value displayed on the Window Content softkey. The 'green border' round the window shows the active window.
Notes:	Window selection is performed on front panel using the 'Next Window' key.
Example:	:DISP:WIND:SEL 2 :DISP:WIND:SEL?

4.4.4.5 Meas setup

Displays the measurement setup menu for the AM Depth Measurement when the AM Depth **Measurement** key has been selected in the **Measure** menu.

4.4.4.5.1 IF BW Used to specify the IF BW, if the IF BW Type is set to Man.

Mode:	MRECEIVE
Key Path:	Meas Setup
Remote Command:	[:SENSE] :AMDepth:BANDwidth BWIDth <freq> [:SENSe] :AMDepth:BANDwidth BWIDth?
Preset:	1MHz
State Saved:	Saved in instrument state.
Range:	1 kHz to 10 MHz
Notes:	When IF BW Type is set to “AUTO” or “MIN”, the measurement does not use this value.
Example:	:AMD:BAND 1MHz :AMD:BAND?

4.4.4.5.2 IF BW Type Used to adjust the IF Bandwidth that the analyzer uses while making a modulation measurement. In this measurement, there are three BW types: Auto, Manual and Minimal. However, the parameter can be set only when Bandwidth Type is set to Manual. In Auto and Minimal types, the system determines this parameter automatically. Usually auto mode is sufficient for most measurement conditions, but this parameter allows adjustment when challenging measurement conditions exist. Signals with hard to measure bandwidths, such as low rate and high deviation FM/PM signals are an example. A value that is very close to the actual signal bandwidth should be used in this case. (If the value is too low, an inaccurate measurement reading will result, whereas a value too high will allow unwanted noise and increase measurement time, unnecessarily.) The type of IF bandwidths that the PSA uses can vary from ~25 kHz to 8 MHz.

- **Auto:** This is the default setting. This setting causes system to perform an occupied bandwidth measurement on the modulated signal. This measurement will occur at the start of any modulation measurement, and will help determine the final IF bandwidth that the PSA will use in analyzing the signal. The main drawback of this mode is measurement throughput; extra time is required during initialization to perform the bandwidth measurement.
- **Manual:** In this mode you can use the IF Bandwidth parameter to suggest a bandwidth for the system to use during demodulation. The actual IF bandwidth that is used will try to be greater than this value, and at a point where the PSA is optimized to produce fast, accurate results. In this mode measurement throughput is increased because initialization bandwidth measurements are bypassed. Another use of this mode is to ensure that the analyzer is behaving correctly for signals whose bandwidth is hard to measure (that is, low rate audio signals).

Measurement keys

- **Minimal:** This will choose the minimum IF bandwidth necessary to perform the modulation measurement. The minimum bandwidth used is determined by the Low Pass Filter setting and is a value that is $> 2 \times \text{LowPassFilter}$. This mode usually works for most signals with a low modulation index. This mode will increase measurement throughput because the analyzer can bypass the bandwidth measurement routines that are performed at initialization for the Auto mode.

Mode:	MRECEIVE
Key Path:	Meas Setup
Remote Command:	[:SENSE] :AMDepth: BANDwidth BWIDth: TYPE MIN AUTO MAN [:SENSE] :AMDepth: BANDwidth BWIDth: TYPE?
Preset:	AUTO
State Saved:	Saved in instrument state.
Range:	Auto Man Min
Example:	:AMD: BAND: TYPE MIN :AMD: BAND: TYPE?

4.4.4.5.3 Average Number Sets the number that will be averaged. After the specified number (average counts) have been averaged, the averaging mode (termination control) setting determines the averaging action.

Mode:	MRECEIVE
Key Path:	Meas Setup
Remote Command:	[:SENSE] :AMDepth: AVERage: COUNT <integer> [:SENSE] :AMDepth: AVERage: COUNT? [:SENSE] :AMDepth: AVERage [:STATe] OFF ON 0 1 [:SENSE] :AMDepth: AVERage [:STATe] ?
Preset:	25, ON
State Saved:	Saved in instrument state.
Min:	1
Max:	8192
Example:	:AMD: AVER: COUN 25 :AMD: AVER: COUN? :AMD: AVER: STAT OFF :AMD: AVER: STAT?

4.4.4.5.4 Average Mode Selects the type of termination control used for averaging. This determines the averaging action after the specified number of frames(average count) is reached.

- **Exponential** - Each successive data acquisition after the average count is reached, is exponentially weighted and combined with the existing average.
- **Repeat** - After reaching the average count, the averaging is reset and a new average is started.

Mode:	MRECEIVE
Key Path:	Meas Setup
Remote Command:	[:SENSe] :AMDepth:AVERage:TYPE REP EXP [:SENSe] :AMDepth:AVERage:TYPE?
Preset:	REP
State Saved:	Saved in instrument state.
Range:	Repeat Exponential
Example:	:AMD:AVER:TYPE EXP :AMD:AVER:TYPE?

4.4.4.5.5 Trig Source Displays menu keys that enable you to select the trigger mode of a measurement. When in a trigger mode other than Free Run, the analyzer will begin the measurement only when the proper trigger condition is met. This key is available only when sub-option 23A is installed. The following trigger menu keys are available:

- **Free Run (Immediate)** - The next measurement is taken immediately, capturing the signal asynchronously (also called Immediate).
- **Video (IF Envlp)** - An internal IF envelope trigger that occurs at the absolute threshold level of the IF signal.
- **RF Burst (IF Wideband)** - An internal wideband RF burst trigger that has an automatic level control for burst signals. It triggers on a level that is relative to the peak of the signal passed by the RF or absolute level.
- **Ext Front** - Sets the trigger directly to an external signal connected to the front-panel **EXT TRIGGER INPUT** connector. No measurement will be made unless a signal is connected to the **EXT TRIGGER INPUT** connector on the front panel.
- **Ext Rear** - Sets the trigger directly to an external signal connected to the rear-panel **TRIGGER IN** connector. No measurement will be made unless a signal is connected to the **TRIGGER IN** connector on the rear panel.

Key Path:	Meas Setup
Remote Command:	[:SENSe] :AMDepth:TRIGger:SOURce IMMEDIATE IF EXTernal [1] EXTernal [2] RFBurst [:SENSe] :AMDepth:TRIGger:SOURce?
Default:	IMMEDIATE
State Saved:	Saved in instrument state.
Range:	Free Run (Immediate) Video (IF Envlp) RF Burst Ext Front Ext Rear
Example:	:AMD:TRIG:SOUR IF :AMD:TRIG:SOUR?

4.4.4.5.6 Capture Time Sets the capturing data time. When in manual mode, the user determines the capture time; otherwise, it is determined automatically by the measurement.

This key is available only when sub-option 23A is installed.

Key Path:	Meas Setup
Remote Command:	[:SENSe]:AMDepth:CAPTure <seconds> [:SENSe]:AMDepth:CAPTure? [:SENSe] :AMDepth:CAPTure:AUTO 0 1 ON OFF [:SENSe]:AMDepth:CAPTure:AUTO?
Preset/Default:	250 ms
State Saved:	Saved in instrument state.
Min:	1 μ s
Max:	10 s
Resolution	1 ms
Example:	:AMD:CAPT 0.25 :AMD:CAPT? :AMD:CAPT:AUTO OFF :AMD:CAPT:AUTO?

4.4.4.5.7 Fast Mode Allows you to toggle the **Fast Mode** between **On** and **Off**. Fast Mode can speed up the measurement.

Key Path:	Meas Setup
Remote Command:	[:SENSe] :AMDepth:FAST 0 1 OFF ON [:SENSe] :AMDepth:FAST?
Default:	OFF
State Saved:	Saved in instrument state.
Range:	ON OFF
Example:	:AMD:FAST ON :AMD:FAST?

4.4.4.5.8 AM Depth Only Allows you to select only the results of AM depth. When it is NO, you can get the results of AM depth, modulation rate, distortion, and sinad at the same time. When it is YES, you can only get the results of AM depth. All others will return - 999, which can help to increase the speed of the measurement.

Key Path:	Meas Setup, More
Remote Command:	[:SENSe] :AMDepth:ONLY YES NO [:SENSe] :AMDepth:ONLY?
Default:	NO
State Saved:	Saved in instrument state.
Range	YES NO
Example:	:AMD:ONLY NO :AMD:ONLY?

4.4.5 FM Deviation Measurement

The FM Deviation measurement consists of 2 views: Numeric Results View and Waveform View

1. FM Deviation Numeric Results View has two windows:
 - FM Deviation Numeric Results Window (upper)
 - FM Deviation Settings Window (lower)

Table 4-13 FM Deviation Numeric Results Window

Name	Corresponding Results
FM Deviation	n=1 1st FM Deviation output
Modulation Rate	n=1 3rd
Modulation Distortion	n=1 4th
Modulation SINAD	n=1 5th

Table 4-14 FM Deviation Settings Window

Name	Corresponding Results
IF BW Type	It can be Auto, Manual
IF BW	This value is the IF bandwidth set manually
Detector Selection	It can be Peak +, Peak -, Peak +/- 2 or RMS
Peak Hold	It can be On or Off
HP Filter	It can be None, 50 Hz or 300 Hz
LP Filter	It can be None, 3 kHz, 15 kHz, 30 kHz or 300 kHz
De-emphasis Filter	It can be None, 25 us, 50 us, 75 us, or 750 us

2. FM Deviation Demod Waveform View has two windows:
 - FM Deviation Waveform Window (lower)
 - FM Deviation Numeric Results Window (upper)

Table 4-15 FM Deviation Waveform Window

Marker Trace	Yes
Corresponding Trace	FM Deviation vs. Seconds trace (n=0)

Table 4-16 FM Deviation Numeric Results Window

Name	Corresponding Results
FM Deviation	N=1 1st FM Deviation output
Modulation Rate	n=1 3rd
Modulation Distortion	n=1 4th
Modulation SINAD	n=1 5th

4.4.5.1 SPAN/X Scale

The SPAN/X Scale key accesses the menu to set the desired horizon scale and associated settings of waveform.

4.4.5.1.1 Scale/Div This key is for Scale/Div control

Mode:	MRECEIVE
Key Path:	Span X Scale
Remote Command:	:DISPlay:FMDeviation [1] 2:WINDow [1] 2 3 4:TRACe:X [:SCALE] :PDIVision <seconds> :DISPlay:FMDeviation [1] 2:WINDow [1] 2 3 4:TRACe:X [:SCALE] :PDIVision?
Unit:	Seconds
Preset:	100us
State Saved:	Saved in instrument state.
Min:	1.0 ns
Max:	1 s
Dependencies/Couplings:	See Restriction and Notes
Notes:	If the Scale Coupling is set to On, this value is automatically determined by the measurement result. When you set this value manually, Scale Coupling automatically changes to Off.
Example:	:DISP:FMD:WIND:TRAC:X:PDIV 100us :DISP:FMD:WIND:TRAC:X:PDIV?

Front-Panel Key and SCPI Command Reference

4.4.5.1.2 Ref Value Allows you to set the display reference.

Mode:	MRECEIVE
Key Path:	Span X Scale
Remote Command:	:DISPlay:FMDeviatiOn[1] 2:WINDow[1] 2 3 4:TRACe:X[:SCALe] :R LEVel <seconds> :DISPlay:FMDeviatiOn[1] 2:WINDow[1] 2 3 4:TRACe:X[:SCALe] :R LEVel?
Unit:	Seconds
Preset:	0.0
State Saved:	Saved in instrument state.
Min:	1 ns
Max:	10 s
Dependencies/Couplings:	See Restriction and Notes
Notes:	If the Scale Coupling is set to On, this value is automatically determined by the measurement result. When you set this value manually, Scale Coupling automatically changes to Off.
Example:	:DISP:FMD2:WIND:TRAC:X:RLEV 0s :DISP:FMD2:WIND:TRAC:X:RLEV?

4.4.5.1.3 Ref Position Allows you to set the display reference position to either Left, Ctr (center), or Right.

Mode:	MRECEIVE
Key Path:	Span X Scale
Remote Command:	:DISPlay:FMDeviatiOn[1] 2:WINDow[1] 2 3 4:TRACe:X[:SCALe] :RPOSitiOn LEFT CENTer RIGHT :DISPlay:FMDeviatiOn[1] 2:WINDow[1] 2 3 4:TRACe:X[:SCALe] :RPOS itiOn?
Preset:	LEFT
State Saved:	Saved in instrument state.
Range:	Left Ctr Right
Example:	:DISP:FMD:WIND:TRAC:X:RPOS CENT :DISP:FMD:WIND:TRAC:X:RPOS?

4.4.5.1.4 Scale Coupling Allows you to toggle the scale coupling function between On and Off.

Mode:	MRECEIVE
Key Path:	Span X Scale
Remote Command:	:DISPlay:FMDeviatiOn[1] 2:WINDow[1] 2 3 4:TRACe:X[:SCALe]:COUPle 0 1 OFF ON :DISPlay:FMDeviatiOn[1] 2:WINDow[1] 2 3 4:TRACe:X[:SCALe]:COUPle?
Preset:	ON
State Saved:	Saved in instrument state.
Range:	Off On
Dependencies/Couplings:	See Restriction and Notes
Notes:	Upon pressing the Restart front-panel key or Restart softkey under the Meas Control menu, the scale coupling function automatically determines the scale per division and reference values based on the measurement results if this parameter is set to On. When you set a value to either Scale/Div or Ref Value manually, Scale Coupling automatically changes to Off.
Example:	:DISP:FMD:WIND:TRAC:X:COUP OFF :DISP:FMD:WIND:TRAC:X:COUP?

4.4.5.2 AMPLITUDE/Y Scale

The AMPLITUDE/Y Scale key accesses the menu to set the desired vertical scale and associated settings:

Default numbers are independent for each window.

4.4.5.2.1 FM Deviation Numeric Results Window If Numeric Results Window is chosen, the following menu is available.

4.4.5.2.1.1 Display Mode If measurement results are to be displayed relative to a reference, enter the value as a ratio reference by selecting **RATIO**.

Mode:	MRECEIVE
Key Path:	Amplitude Y Scale
Remote Command:	:DISPlay:FMDeviation:MODE NORMal RATio :DISPlay:FMDeviation:MODE?
Preset:	NORMal
State Saved:	Saved in instrument state.
Range:	Normal Ratio
Example:	:DISP:FMD:MODE NORM :DISP:FMD:MODE?

4.4.5.2.1.2 Display Unit Sets unit for Normal display mode.

Mode:	MRECEIVE
Key Path:	Amplitude Y Scale
Remote Command:	:DISPlay:FMDeviation:UNIT HZ KHZ :DISPlay:FMDeviation:UNIT?
Preset:	HZ
State Saved:	Saved in instrument state.
Range:	Hz kHz
Example:	:DISP:FMD:UNIT HZ :DISP:FMD:UNIT?

4.4.5.2.1.3 Ratio Reference If FM Deviation is to be displayed relative to a reference, enter the value as a ratio reference using this key.

Mode: MRECEIVE

Key Path: **Amplitude Y Scale**

Remote Command: :DISPlay:FMDeviation:RREFerence <freq>
:DISPlay:FMDeviation:RREFerence?
:DISPlay:FMDeviation:RREFerence:AUTO 0|1|OFF|ON
:DISPlay:FMDeviation:RREFerence:AUTO?

Preset: 1.000Hz

State Saved: Saved in instrument state.

Min: 1Hz

Max: 800kHz

Example: :DISP:FMD:RREF 10
:DISP:FMD:RREF?
:DISP:FMD:RREF:AUTO OFF
:DISP:FMD:RREF:AUTO?

4.4.5.2.1.4 Ratio Mode The ratio and previous ratio functions permit any measurement result to be scaled to a reference. The reference may be either a measurement result or a keyboard entry. The Log/Linear key enables measurement results to be displayed in linear or logarithmic units. In the Ratio mode, measurements are made in the same way as when not in the Ratio mode, however, before the result is displayed, the internal controller converts it to ratio. The following equations are used for computing ratio:

$$(M/R) * 100 \% = \% \text{ ratio for linear display,}$$

$$20 * \log (M/R) = \text{dB ratio for logarithmic display,}$$

where M is the measurement result and R is the ratio reference.

Mode: MRECEIVE

Key Path: **Amplitude Y Scale**

Remote Command: :DISPlay:FMDeviation:RMODE LOG|LINear
:DISPlay:FMDeviation:RMODE?

Preset: LOG

State Saved: Saved in instrument state.

Range: Log | Linear

Example: :DISP:FMD:RMOD LOG
:DISP:FMD:RMOD?

4.4.5.2.2 FM Deviation Waveform Window If the Waveform Window is chosen, the following menu is available.

4.4.5.2.2.1 Scale/Div Allows you to enter a numeric value to change the vertical display sensitivity.

Mode:	MRECEIVE
Key Path:	Amplitude Y Scale
Remote Command:	:DISPlay:FMDeviation[1] 2:WINDow[1] 2 3 4:TRACe:Y[:SCALe]:PDIVision <freq> :DISPlay:FMDeviation[1] 2:WINDow[1] 2 3 4:TRACe:Y[:SCALe]:PDIVision?
Unit:	Hz
Preset:	1000
State Saved:	Saved in instrument state.
Range:	1Hz to 1GHz
Dependencies/Couplings:	See Restriction and Notes
Notes:	If the Scale Coupling is set to On, this value is automatically determined by the measurement result. When you set this value manually, Scale Coupling automatically changes to Off.
Example:	:DISP:FMD2:WIND:TRAC:Y:PDIV 20 :DISP:FMD2:WIND:TRAC:Y:PDIV?

4.4.5.2.2.2 Ref Position Allows you to set the display reference position to either Top, Ctr (center), or Bot (Bottom).

Mode:	MRECEIVE
Key Path:	Amplitude Y Scale
Remote Command:	:DISPlay:FMDeviation[1] 2:WINDow[1] 2 3 4:TRACe:Y[:SCALe]:RPOSition TOP CENTer BOTTom :DISPlay:FMDeviation[1] 2:WINDow[1] 2 3 4:TRACe:Y[:SCALe]:RPOSition?
Preset:	CENTer
State Saved:	Saved in instrument state.
Range:	Top Ctr Bottom
Example:	:DISP:FMD:WIND:TRAC:Y:RPOS TOP :DISP:FMD:WIND:TRAC:Y:RPOS?

4.4.5.2.2.3 Ref Value Allows you to set the absolute power reference.

Mode:	MRECEIVE
Key Path:	Amplitude Y Scale
Remote Command:	:DISPlay:FMDeviatiOn[1] 2:WINDow[1] 2 3 4:TRACe:Y[:SCALe]:R LEVel <freq> :DISPlay:FMDeviatiOn[1] 2:WINDow[1] 2 3 4:TRACe:Y[:SCALe]:R LEVel?
Unit:	Hz
Preset:	0.00
State Saved:	Saved in instrument state.
Min:	-4GHz
Max:	4GHz
Dependencies/Couplings:	See Restriction and Notes
Notes:	If the Scale Coupling is set to On, this value is automatically determined by the measurement result. When you set this value manually, Scale Coupling automatically changes to Off.
Example:	:DISP:FMD:WIND:TRAC:Y:RLEV 0 :DISP:FMD:WIND:TRAC:Y:RLEV?

4.4.5.2.2.4 Scale Coupling Allows you to toggle the scale coupling function between On and Off.

Mode:	MRECEIVE
Key Path:	Amplitude Y Scale
Remote Command:	:DISPlay:FMDeviatiOn[1] 2:WINDow[1] 2 3 4:TRACe:Y[:SCALe]:C OUPle 0 1 OFF ON :DISPlay:FMDeviatiOn[1] 2:WINDow[1] 2 3 4:TRACe:Y[:SCALe]:C OUPle?
Preset:	OFF
State Saved:	Saved in instrument state.
Range:	On Off
Dependencies/Couplings:	See Restriction and Notes
Notes:	Upon pressing the Restart front-panel key or Restart softkey under the Meas Control menu, the scale coupling function automatically determines the scale per division and reference values based on the measurement results if this parameter is set to On. When you set a value to either Scale/Div or Ref Value manually, Scale Coupling automatically changes to Off.

Measurement keys

Example: :DISP:FMD:WIND:TRAC:Y:COUP OFF
 :DISP:FMD:WIND:TRAC:Y:COUP?

4.4.5.3 Trace / View

Allows you to select the desired measurement view from the following selections:

- Numeric results
- Waveform result

Mode: MRECEIVE
 Key Path: **View/Display**
 Preset: NUMeric
 State Saved: Saved in instrument state.
 Range: Numeric results | Waveform result

4.4.5.4 Meas Setup

Displays the measurement setup menu for the FM Deviation Measurement when the FM Deviation Measurement key has been selected in the Measure menu.

4.4.5.4.1 IF BW Used to specify the IF BW, if the IF BW Type is set to Man.

Mode: MRECEIVE
 Key Path: **Meas Setup**
Remote Command: [:SENSe]:FMDeviation:BANDwidth|BWIDth <freq>
 [:SENSe]:FMDeviation:BANDwidth|BWIDth?
 Preset: 1MHz
 State Saved: Saved in instrument state.
 Range: 1 kHz to 10 MHz
 Notes: When IF BW Type is set to “AUTO”, the measurement does not use this value.
 Example: :FMD:BAND 1MHz
 :FMD:BAND?

4.4.5.4.2 IF BW Type Selects the type of using IF BW. It can be automatically set by measurement, or manually set by user. The function of the two types can reference to FM Deviation's.

Mode:	MRECEIVE
Key Path:	Meas Setup
Remote Command:	<code>[:SENSe] :FMDeviation :BANDwidth BWIDth :TYPE AUTO MAN</code> <code>[:SENSe] :FMDeviation :BANDwidth BWIDth :TYPE ?</code>
Preset:	AUTO
State Saved:	Saved in instrument state.
Range:	Auto Man
Example:	<code>:FMD :BAND :TYPE MAN</code> <code>:FMD :BAND :TYPE ?</code>

4.4.5.4.3 Average Number Sets the number that will be averaged. After the specified number (average counts) have been averaged, the averaging mode (termination control) setting determines the averaging action.

Mode:	MRECEIVE
Key Path:	Meas Setup
Remote Command:	<code>[:SENSe] :FMDeviation :AVERage :COUNT <integer></code> <code>[:SENSe] :FMDeviation :AVERage :COUNT ?</code> <code>[:SENSe] :FMDeviation :AVERage [:STATe] OFF ON 0 1</code> <code>[:SENSe] :FMDeviation :AVERage [:STATe] ?</code>
Preset:	25, ON
State Saved:	Saved in instrument state.
Min:	1
Max:	8192
Example:	<code>:FMD :AVER :COUN 25</code> <code>:FMD :AVER :COUN ?</code> <code>:FMD :AVER :STAT OFF</code> <code>:FMD :AVER :STAT ?</code>

4.4.5.4.4 Average Mode Selects the type of termination control used for averaging. This determines the averaging action after the specified number of frames (average count) is reached.

Exponential - Each successive data acquisition after the average count is reached, is exponentially weighted and combined with the existing average.

Repeat - After reaching the average count, the averaging is reset and a new average is started.

Mode:	MRECEIVE
Key Path:	Meas Setup
Remote Command:	[:SENSE] :FMDeviation:AVERage:TYPE REP EXP [:SENSE] :FMDeviation:AVERage:TYPE?
Preset:	REP
State Saved:	Saved in instrument state.
Range:	Repeat Exponential
Example:	:FMD:AVER:TYPE EXP :FMD:AVER:TYPE?

4.4.5.4.5 Trig Source Displays menu keys that enable you to select the trigger mode of a measurement. When in a trigger mode other than Free Run, the analyzer will begin the measurement only when the proper trigger condition is met. This key is available only when sub-option 23A is installed. The following trigger menu keys are available:

- **Free Run (Immediate)** - The next measurement is taken immediately, capturing the signal asynchronously (also called Immediate).
- **Video (IF Envlp)** - An internal IF envelope trigger that occurs at the absolute threshold level of the IF signal.
- **RF Burst (IF Wideband)** - An internal wideband RF burst trigger that has an automatic level control for burst signals. It triggers on a level that is relative to the peak of the signal passed by the RF or absolute level.
- **Ext Front** - Sets the trigger directly to an external signal connected to the front-panel **EXT TRIGGER INPUT** connector. No measurement will be made unless a signal is connected to the **EXT TRIGGER INPUT** connector on the front panel.
- **Ext Rear** - Sets the trigger directly to an external signal connected to the rear-panel **TRIGGER IN** connector. No measurement will be made unless a signal is connected to the **TRIGGER IN** connector on the rear panel.

Key Path:	Meas Setup
Remote Command:	[:SENSe] :FMDev:TRIGger:SOURce IMMEDIATE IF EXTERNAL [1] EXTERNAL [2] RFBURST [:SENSe] :FMDev:TRIGger:SOURce?
Default:	IMMEDIATE
State Saved:	Saved in instrument state.
Range:	Free Run (Immediate) Video (IF Envlp) RF Burst Ext Front Ext Rear
Example:	:FMD:TRIG:SOUR IF :FMD:TRIG:SOUR?

4.4.5.4.6 Capture Time Sets the capturing data time. When in manual mode, the user determines the capture time; otherwise, it is determined automatically by the measurement.

This key is available only when sub-option 23A is installed.

Key Path:	Meas Setup
Remote Command:	[:SENSe] :FMDev:CAPTure <seconds> [:SENSe] :FMDev:CAPTure? [:SENSe] :FMDev:CAPTure:AUTO 0 1 ON OFF [:SENSe] :FMDev:CAPTure:AUTO?
Preset/Default:	250 ms
State Saved:	Saved in instrument state.
Min:	1 μ s
Max:	10 s
Resolution	1 ms
Example:	:FMD:CAPT 0.25 :FMD:CAPT? :FMD:CAPT:AUTO OFF :FMD:CAPT:AUTO?

Measurement keys

4.4.5.4.7 Fast Mode Allows you to toggle the **Fast Mode** between **On** and **Off**. Fast Mode can speed up the measurement.

Key Path:	Meas Setup
Remote Command:	[:SENSe] :FMDev:FAST 0 1 OFF ON [:SENSe] :FMDev:FAST?
Default:	OFF
State Saved:	Saved in instrument state.
Range:	ON OFF
Example:	:FMD:FAST ON :FMD:FAST?

4.4.5.4.8 FM Dev Only Allows you to select only the results of FM deviation. When it is NO, you can get the results of FM deviation, modulation rate, distortion, and sinad at the same time. When it is YES, you can only get the results of FM deviation. All others will return - 999, which can help to increase the speed of the measurement.

Key Path:	Meas Setup, More
Remote Command:	[:SENSe] :FMDev:ONLY YES NO [:SENSe] :FMDEev:ONLY?
Default:	NO
State Saved:	Saved in instrument state.
Range	YES NO
Example:	:FMD:ONLY NO :FMD:ONLY?

4.4.6 PM Deviation Measurement Definition

The PM Deviation measurement consists of 2 views: Numeric Results View and Waveform View.

1. PM Deviation Numeric Results View has two windows:
 - PM Deviation Numeric Results Window (upper)
 - PM Deviation Settings Window (lower)

Table 4-17 PM Deviation Numeric Results Window

Name	Corresponding Results
PM Deviation	n=1 1st PM Deviation output
Modulation Rate	n=1 3rd
Modulation Distortion	n=1 4th
Modulation SINAD	n=1 5th

Table 4-18 PM Deviation Settings Window

Name	Corresponding Results
IF BW Type	It can be Auto, Manual
IF BW	This value is the IF bandwidth set manually
Detector Selection	It can be Peak +, Peak -, Peak +/- 2 or RMS
Peak Hold	It can be On or Off
HP Filter	It can be None, 50 Hz or 300 Hz
LP Filter	It can be None, 3 kHz, 15 kHz, 30 kHz or 300 kHz

2. PM Deviation Demod Waveform View has two windows:
 - PM Deviation Waveform Window (upper)
 - PM Deviation Numeric Results Window (lower)

Table 4-19 PM Deviation Waveform Window

Marker Trace	Yes
Corresponding Trace	PM Deviation vs. Seconds trace (n=0)

Table 4-20 PM Deviation Numeric Results Window

Name	Corresponding Results
PM Deviation	n=1 1st PM Deviation output
Modulation Rate	n=1 3rd
Modulation Distortion	n=1 4th
Modulation SINAD	n=1 5th

4.4.6.1 SPAN/X Scale

The SPAN/X Scale key accesses the menu to set the desired horizon scale and associated settings of waveform.

4.4.6.1.1 Scale/Div This key is for Scale/Div control

Key Path:	Span X Scale
Remote Command:	:DISPlay:PMDeviation [1] 2:WINDow [1] 2 3 4:TRACe:X [:SCALE] :PDIVision <seconds> :DISPlay:PMDeviation [1] 2:WINDow [1] 2 3 4:TRACe:X [:SCALE] :PDIVision?
Unit:	Seconds
Preset:	100us
State Saved:	Saved in instrument state.
Min:	1.0 ns
Max:	1 s
Dependencies/Couplings:	See Restriction and Notes
Notes:	If the Scale Coupling is set to On, this value is automatically determined by the measurement result. When you set this value manually, Scale Coupling automatically changes to Off.
Example:	:DISP:PMD:WIND:TRAC:X:PDIV 100us :DISP:PMD:WIND:TRAC:X:PDIV?

4.4.6.1.2 Ref Value Allows you to set the display reference.

Key Path:	Span X Scale
Remote Command:	:DISPlay:PMDeviatiOn[1] 2:WINDow[1] 2 3 4:TRACe:X[:SCALe]:R LEVEl <seconds> :DISPlay:PMDeviatiOn[1] 2:WINDow[1] 2 3 4:TRACe:X[:SCALe]:R LEVEl?
Unit:	Seconds
Preset:	0.0
State Saved:	Saved in instrument state.
Min:	1 ns
Max:	10 s
Dependencies/Couplings:	See Restriction and Notes
Notes:	If the Scale Coupling is set to On, this value is automatically determined by the measurement result. When you set this value manually, Scale Coupling automatically changes to Off.
Example:	:DISP:PMD:WIND2:TRAC:X:RLEV 0s :DISP:PMD:WIND2:TRAC:X:RLEV?

4.4.6.1.3 Ref Position Allows you to set the display reference position to either Left, Ctr (center), or Right.

Key Path:	Span X Scale
Remote Command:	:DISPlay:PMDeviatiOn[1] 2:WINDow[1] 2 3 4:TRACe:X[:SCALe] :RPOSitiOn LEFT CENTer RIGHT :DISPlay:PMDeviatiOn[1] 2:WINDow[1] 2 3 4:TRACe:X[:SCALe]:RPOS itiOn?
Preset:	LEFT
State Saved:	Saved in instrument state.
Range:	Left Ctr Right
Notes:	None
Example:	:DISP:PMD:WIND:TRAC:X:RPOS 5 :DISP:PMD:WIND:TRAC:X:RPOS?

4.4.6.1.4 Scale Coupling

Allows you to toggle the scale coupling function between On and Off.

Key Path:	Span X Scale
Remote Command:	:DISPlay:PMDeviatiOn[1] 2:WINDow[1] 2 3 4:TRACe:X[:SCALe]:COUPle 0 1 OFF ON :DISPlay:PMDeviatiOn[1] 2:WINDow[1] 2 3 4:TRACe:X[:SCALe]:COUPle?
Preset:	ON
State Saved:	Saved in instrument state.
Range:	Off On
Dependencies/Couplings:	See Restriction and Notes
Notes:	Upon pressing the Restart front-panel key or Restart softkey under the Meas Control menu, the scale coupling function automatically determines the scale per division and reference values based on the measurement results if this parameter is set to On. When you set a value to either Scale/Div or Ref Value manually, Scale Coupling automatically changes to Off.
Example:	:DISP:PMD:WIND:TRAC:X:COUP OFF :DISP:PMD:WIND:TRAC:X:COUP?

4.4.6.2 AMPLITUDE/Y Scale

The AMPLITUDE/Y Scale key accesses the menu to set the desired vertical scale and associated settings:

Default numbers are independent for each window.

4.4.6.2.1 PM Deviation Numeric Results Window If Numeric Results Window is chosen, the following menu is available.

4.4.6.2.1.1 Display Mode If measurement results are to be displayed relative to a reference, enter the value as a ratio reference by selecting RATIO.

Key Path:	Amplitude Y Scale
Remote Command:	:DISPlay:PMDeviatiOn:MODE NORMal RATio :DISPlay:PMDeviatiOn:MODE?
Preset:	NORMal
State Saved:	Saved in instrument state.
Range:	Normal Ratio
Example:	:DISP:PMD:MODE NORM :DISP:PMD:MODE?

4.4.6.2.1.2 Display Unit Sets unit for Normal display mode.

Key Path:	Amplitude Y Scale
Remote Command:	:DISPlay:PMDeviation:UNIT RAD DEG :DISPlay:PMDeviation:UNIT?
Preset:	RAD
State Saved:	Saved in instrument state.
Range:	rad deg
Example:	:DISP:PMD:UNIT RAD :DISP:PMD:UNIT?

4.4.6.2.1.3 Ratio Reference If PM deviation is to be displayed relative to a reference, enter the value as a ratio reference using this key.

Key Path:	Amplitude Y Scale
Remote Command:	:DISPlay:PMDeviation:RREference <degrees> :DISPlay:PMDeviation:RREference? :DISPlay:PMDeviation:RREference:AUTO 0 1 OFF ON :DISPlay:PMDeviation:RREference:AUTO?
Preset:	1.000
State Saved:	Saved in instrument state.
Min:	0.1rad
Max:	800rad
Example:	:DISP:PMD:RREF 1.0 :DISP:PMD:RREF? :DISP:PMD:RREF:AUTO OFF :DISP:PMD:RREF:AUTO?

4.4.6.2.1.4 Ratio Mode The ratio and previous ratio functions permit any measurement result to be scaled to a reference. The reference may be either a measurement result or a keyboard entry. The Log/Linear key enables measurement results to be displayed in linear or logarithmic units. In the Ratio mode, measurements are made in the same way as when not in the Ratio mode, however, before the result is displayed, the internal controller converts it to ratio. The following equations are used for computing ratio:

$$(M/R) * 100 \% = \% \text{ ratio for linear display,}$$

$$20 * \log (M/R) = \text{dB ratio for logarithmic display,}$$

where M is the measurement result and R is the ratio reference.

Key Path:	Amplitude Y Scale
Remote Command:	:DISPlay:PMDeviatiOn:RMODe LOG LINear :DISPlay:PMDeviatiOn:RMODe?
Preset:	LOG
State Saved:	Saved in instrument state.
Range:	Log Linear
Example:	:DISP:PMD:RMOD LOG :DISP:PMD:RMOD?

4.4.6.2.2 PM Deviation Waveform Window If the waveform window is chosen, the following menu is available.

4.4.6.2.2.1 Scale/Div Allows you to enter a numeric value to change the vertical display sensitivity.

Key Path:	Amplitude Y Scale
Remote Command:	:DISPlay:PMDeviatiOn[1] 2:WINDow[1] 2 3 4:TRACe:Y[:SCALe]:PDIVision <angle> :DISPlay:PMDeviatiOn[1] 2:WINDow[1] 2 3 4:TRACe:Y[:SCALe]:PDIVision?
Unit:	RAD
Preset:	1.0
State Saved:	Saved in instrument state.
Range:	1mrad to 62.8rad
Dependencies/Couplings:	See Restriction and Notes
Notes:	If the Scale Coupling is set to On, this value is automatically determined by the measurement result. When you set this value manually, Scale Coupling automatically changes to Off.
Example:	:DISP:PMD:WIND:TRAC:Y:PDIV 20 :DISP:PMD:WIND:TRAC:Y:PDIV?

4.4.6.2.2.2 Ref Value Allows you to set the absolute power reference.

Key Path:	Amplitude Y Scale
Remote Command:	:DISPlay:PMDeviatiOn[1] 2:WINDow[1] 2 3 4:TRACe:Y[:SCALe] :R LEVel <angle> :DISPlay:PMDeviatiOn[1] 2:WINDow[1] 2 3 4:TRACe:Y[:SCALe] :R LEVel?
Unit:	rad
Preset:	0.00
State Saved:	Saved in instrument state.
Min:	-628 rad
Max:	628 rad
Dependencies/Couplings:	See Restriction and Notes
Notes:	If the Scale Coupling is set to On, this value is automatically determined by the measurement result. When you set this value manually, Scale Coupling automatically changes to Off.
Example:	:DISP:PMD:WIND:TRAC:Y:RLEV 0 :DISP:PMD:WIND:TRAC:Y:RLEV?

Front-Panel Key and SCPI Command Reference

4.4.6.2.2.3 Ref Position Allows you to set the display reference position to either Top, Ctr (center), or Bot (Bottom).

Key Path:	Amplitude Y Scale
Remote Command:	:DISPlay:PMDeviatiOn[1] 2:WINDow[1] 2 3 4:TRACe:Y[:SCALe] :RPOSitiOn TOP CENTer BOTTom :DISPlay:PMDeviatiOn[1] 2:WINDow[1] 2 3 4:TRACe:Y[:SCALe] :RPOSi tion?
Preset:	CENTer
State Saved:	Saved in instrument state.
Range:	Top Ctr Bottom
Example:	:DISP:PMD:WIND:TRAC:Y:RPOS TOP :DISP:PMD:WIND:TRAC:Y:RPOS?

4.4.6.2.2.4 Scale Coupling Allows you to toggle the scale coupling function between On and Off.

Key Path:	Amplitude Y Scale
Remote Command:	:DISPlay:PMDeviation[1] 2:WINDow[1] 2 3 4:TRACe:Y[:SCALe] :COUPle 0 1 OFF ON :DISPlay:PMDeviation[1] 2:WINDow[1] 2 3 4:TRACe:Y[:SCALe] :COUPle?
Preset:	OFF
State Saved:	Saved in instrument state.
Range:	On Off
Dependencies/Couplings:	See Restriction and Notes
Notes:	Upon pressing the Restart front-panel key or Restart softkey under the Meas Control menu, the scale coupling function automatically determines the scale per division and reference values based on the measurement results if this parameter is set to On. When you set a value to either Scale/Div or Ref Value manually, Scale Coupling automatically changes to Off.
Example:	:DISP:PMD:WIND:TRAC:Y:COUP OFF :DISP:PMD:WIND:TRAC:Y:COUP?

4.4.6.3 Trace / View

Allows you to select the desired measurement view from the following selections:

- Numeric Results
- Demod Waveform

Mode:	MRECEIVE
Key Path:	View/Display
Preset:	NUMeric
State Saved:	Saved in instrument state.
Range:	Numeric results Waveform result

4.4.6.4 Meas Setup

4.4.6.4.1 IF BW Used specify the IF BW, if the IF BW Type is set to Man.

Key Path:	Meas Setup
Remote Command:	[:SENSE] :PMDeviation :BANDwidth BWIDth <freq> [:SENSE] :PMDeviation :BANDwidth BWIDth ?
Preset:	1MHz
State Saved:	Saved in instrument state.
Range:	1 kHz to 10 MHz
Notes:	When IF BW Type is set to “AUTO”, the measurement does not use this value.
Example:	:PMD:BAND 1MHz :PMD:BAND ?

4.4.6.4.2 IF BW Type Selects the type of using IF BW. It can be automatically set by measurement, or manually set by user. The function of the tow types can reference to AM depth's.

Key Path:	Meas Setup
Remote Command:	[:SENSE] :PMDeviation :BANDwidth BWIDth :TYPE AUTO MAN [:SENSE] :PMDeviation :BANDwidth BWIDth :TYPE ?
Preset:	AUTO
State Saved:	Saved in instrument state.
Range:	Auto Man
Example:	:PMD:BAND:TYPE MAN :PMD:BAND:TYPE ?

4.4.6.4.3 Average Number Sets the number that will be averaged. After the specified number (average counts) have been averaged, the averaging mode (termination control) setting determines the averaging action.

Key Path:	Meas Setup
Remote Command:	[:SENSE]:PMDeviation:AVERage:COUNT <integer> [:SENSE]:PMDeviation:AVERage:COUNT? [:SENSE]:PMDeviation:AVERage[:STATe] OFF ON 0 1 [:SENSE]:PMDeviation:AVERage[:STATe]?
Preset:	25, ON
State Saved:	Saved in instrument state.
Min:	1
Max:	8192
Example:	:PMD:AVER:COUN 25 :PMD:AVER:COUN? :PMD:AVER:STAT OFF :PMD:AVER:STAT?

4.4.6.4.4 Average Mode Selects the type of termination control used for averaging. This determines the averaging action after the specified number of frames (average count) is reached.

- Exponential - Each successive data acquisition after the average count is reached, is exponentially weighted and combined with the existing average.
- Repeat - After reaching the average count, the averaging is reset and a new average is started.

Key Path:	Meas Setup
Remote Command:	[:SENSE]:PMDeviation:AVERage:TYPE REP EXP [:SENSE]:PMDeviation:AVERage:TYPE?
Preset:	REP
State Saved:	Saved in instrument state.
Range:	Repeat Exponential
Example:	:PMD:AVER:TYPE EXP :PMD:AVER:TYPE?

4.4.6.4.5 Trig Source Displays menu keys that enable you to select the trigger mode of a measurement. When in a trigger mode other than Free Run, the analyzer will begin the measurement only when the proper trigger condition is met. This key is available only when sub-option 23A is installed. The following trigger menu keys are available:

- **Free Run (Immediate)** - The next measurement is taken immediately, capturing the signal asynchronously (also called Immediate).
- **Video (IF Envlp)** - An internal IF envelope trigger that occurs at the absolute threshold level of the IF signal.
- **RF Burst (IF Wideband)** - An internal wideband RF burst trigger that has an automatic level control for burst signals. It triggers on a level that is relative to the peak of the signal passed by the RF or absolute level.
- **Ext Front** - Sets the trigger directly to an external signal connected to the front-panel **EXT TRIGGER INPUT** connector. No measurement will be made unless a signal is connected to the **EXT TRIGGER INPUT** connector on the front panel.
- **Ext Rear** - Sets the trigger directly to an external signal connected to the rear-panel **TRIGGER IN** connector. No measurement will be made unless a signal is connected to the **TRIGGER IN** connector on the rear panel.

Key Path:	Meas Setup
Remote Command:	[:SENSE] :PMDev:TRIGger:SOURce IMMediate IF EXTernal [1] EXTernal [2] RFBurst [:SENSe] :PMDev:TRIGger:SOURce?
Default:	IMMediate
State Saved:	Saved in instrument state.
Range:	Free Run (Immediate) Video (IF Envlp) RF Burst Ext Front Ext Rear
Example:	:PMD:TRIG:SOUR IF :PMD:TRIG:SOUR?

Measurement keys

4.4.6.4.6 Capture Time Sets the capturing data time. When in manual mode, the user determines the capture time; otherwise, it is determined automatically by the measurement.

This key is available only when sub-option 23A is installed.

Key Path:	Meas Setup
Remote Command:	[:SENSe] :PMDev :CAPTure <seconds> [:SENSe] :PMDev :CAPTure? [:SENSe] :PMDev :CAPTure :AUTO 0 1 ON OFF [:SENSe] :PMDev :CAPTure :AUTO?
Preset/Default:	250 ms
State Saved:	Saved in instrument state.
Min:	1 μs
Max:	10 s
Resolution	1 ms
Example:	:PMD:CAPT 0.25 :PMD:CAPT? :PMD:CAPT:AUTO OFF :PMD:CAPT:AUTO?

4.4.6.4.7 Fast Mode Allows you to toggle the Fast Mode between On and Off. Fast Mode can speed up the measurement.

Key Path:	Meas Setup
Remote Command:	[:SENSe] :PMDev :FAST 0 1 OFF ON [:SENSe] :PMDev :FAST?
Default:	OFF
State Saved:	Saved in instrument state.
Range:	ON OFF
Example:	:PMD:FAST ON :PMD:FAST?

4.4.6.4.8 PM Dev Only Allows you to select only the results of PM deviation. When it is NO, you can get the results of PM deviation, modulation rate, distortion, and sinad at the same time. When it is YES, you can only get the results of PM deviation. All others will return – 999, which can help to increase the speed of the measurement.

Key Path:	Meas Setup, More
Remote Command:	[:SENSe] :PMDev :ONLY YES NO [:SENSe] :PMDEv :ONLY?
Default:	NO
State Saved:	Saved in instrument state.
Range	YES NO
Example:	:PMD:ONLY NO :PMD:ONLY?

4.4.7 Modulation Rate Measurement

NOTE Firstly the PSA will down-convert the RF signal to base-band and then make the specified AM, FM or PM demodulation. Modulation rate (modulation signal frequency) is calculated by a time domain counter.

There is only one view available for Frequency Counter measurement. There are two windows:

- Modulation Rate Numeric Results Window (upper)
- Modulation Rate Settings Window (lower)

Table 4-21 Modulation Rate Numeric Results Window

Name	Corresponding Results
Modulation Rate	n=1, 1st

Table 4-22 Modulation Rate Settings Window

Name	Corresponding Results
IF BW Type	It can be Auto, Manual or Min
IF BW	This value is the IF bandwidth set manually
Detector Selection	It can be Peak +, Peak -, Peak +/- 2 or RMS
Peak Hold	It can be On or Off
HP Filter	It can be None, 50 Hz or 300 Hz
LP Filter	It can be None, 3 kHz, 15 kHz, 30 kHz or 300 kHz
De-emphasis Filter	It can be None, 25 us, 50 us, 75 us, or 750 us

4.4.7.1 Amplitude/Y Scale

The AMPLITUDE/Y Scale key accesses the menu to set the desired vertical scale and associated settings:

Default numbers are independent for each window.

4.4.7.1.1 Display Mode Sets the display mode.

Mode:	MRECEIVE
Key Path:	Amplitude Y Scale
Remote Command:	:DISPlay:MODRate:MODE NORMal RATio :DISPlay:MODRate:MODE?
Preset:	NORMal
State Saved:	Saved in instrument state.
Range:	Normal Ratio
Dependencies/Couplings:	No
Example:	:DISP:MODR:MODE NORM :DISP:MODR:MODE?

4.4.7.1.2 Display Unit Sets unit for Normal display mode.

Mode:	MRECEIVE
Key Path:	Amplitude Y Scale
Remote Command:	:DISPlay:MODRate:UNIT HZ KHZ :DISPlay:MODRate:UNIT?
Preset:	HZ
State Saved:	Saved in instrument state.
Range:	Hz kHz
Example:	:DISP:MODR:UNIT KHZ :DISP:MODR:UNIT?

4.4.7.1.3 Ratio Reference If Frequency is to be displayed relative to a reference, enter the value as a ratio reference using this key.

Mode:	MRECEIVE
Key Path:	Amplitude Y Scale
Remote Command:	:DISPlay:MODRate:RREference <freq> :DISPlay:MODRate:RREference? :DISPlay:MODRate:RREference:AUTO 0 1 OFF ON :DISPlay:MODRate:RREference:AUTO?
Unit:	Hz kHz
Preset:	400 Hz
State Saved:	Saved in instrument state.
Min:	20 Hz
Max:	500 kHz
Dependencies/Couplings:	No
Example:	:DISP:MODR:RREF 400 Hz :DISP:MODR:RREF? :DISP:MODR:RREF:AUTO OFF :DISP:MODR:RREF:AUTO?

4.4.7.1.4 Ratio Mode The ratio and previous ratio functions permit any measurement result to be scaled to a reference. The reference may be either a measurement result or a keyboard entry. The Log/Linear key enables measurement results to be displayed in linear or logarithmic units.

Mode:	MRECEIVE
Key Path:	Amplitude Y Scale
Remote Command:	:DISPlay:MODRate:RMODE LOG LINear :DISPlay:MODRate:RMODE?
Preset:	LOG
State Saved:	Saved in instrument state.
Range:	Log Linear
Dependencies/Couplings:	No
Example:	:DISP:MODR:RMODE LOG :DISP:MODR:RMODE?

4.4.7.2 Meas Setup

4.4.7.2.1 IF BW Used to specify the IF BW, if the IF BW Type is set to Man.

Mode	MRECEIVE
Key Path:	Meas Setup
Remote Command:	[:SENSE] :MODRate:BANDwidth BWIDth <freq> [:SENSE] :MODRate:BANDwidth BWIDth?
Preset:	1 MHz
State Saved:	Saved in instrument state.
Min:	1 kHz
Max:	10 MHz
Example:	:MODR:BAND 1 MHz :MODR:BAND?

4.4.7.2.2 IF BW Type

Used to adjust the IF Bandwidth that the analyzer uses while making a modulation measurement. In this measurement, there are three BW types: Auto, Manual and Minimal. However, the parameter can be set only when Bandwidth Type is set to Manual. In Auto and Minimal types, the system determines this parameter automatically. Usually auto mode is sufficient for most measurement conditions, but this parameter allows adjustment when challenging measurement conditions exist. Signals with hard to measure bandwidths, such as low rate and high deviation FM/PM signals are an example. A value that is very close to the actual signal bandwidth should be used in this case. (If the value is too low, an inaccurate measurement reading will result, whereas a value too high will allow unwanted noise and increase measurement time, unnecessarily.) The type of IF bandwidths that the PSA uses can vary from ~25 kHz to 8 MHz.

- **Auto:** This is the default setting. This setting causes system to perform an occupied bandwidth measurement on the modulated signal. This measurement will occur at the start of any modulation measurement, and will help determine the final IF bandwidth that the PSA will use in analyzing the signal. The main drawback of this mode is measurement throughput; extra time is required during initialization to perform the bandwidth measurement.
- **Manual:** In this mode you can use the IF Bandwidth parameter to suggest a bandwidth for the system to use during demodulation. The actual IF bandwidth that is used will try to be greater than this value, and at a point where the PSA is optimized to produce fast, accurate results. In this mode measurement throughput is increased because initialization bandwidth measurements are bypassed. Another use of this mode is to ensure that the analyzer is behaving correctly for signals whose bandwidth is hard to measure (that is, low rate audio signals).
- **Minimal:** This will choose the minimum IF bandwidth necessary to perform the modulation measurement. The minimum bandwidth used is determined by the Low Pass Filter setting

and is a value that is $> 2 \times \text{LowPassFilter}$. This mode usually works for most signals with a low modulation index. This mode will increase measurement throughput because the analyzer can bypass the bandwidth measurement routines that are performed at initialization for the Auto mode.

Key Path:	Meas Setup
Remote Command:	<code>[:SENSe] :MODRate :BANDwidth BWIDth :TYPE MIN AUTO MAN</code> <code>[:SENSe] :MODRate :BANDwidth BWIDth :TYPE?</code>
Preset:	AUTO
State Saved:	Saved in instrument state.
Range:	Auto Man Min
Dependencies/Couplings:	When user set the IF BW, the IF BW Type is automatically set to “Man”.
Notes:	The IF BW type “Min” is meaningful only when the Modulation Mode is “AM”. For FM, PM signal, the result will not be correct with this IF BW Type.
Example:	<code>:MODR:BAND:TYPE MIN</code> <code>:MODR:BAND:TYPE?</code>

4.4.7.2.3 Avg Mode Selects the type of termination control used for averaging. This determines the averaging action after the specified number of average count is reached.

- Repeat - After reaching the average count, the averaging is reset and a new average is started
- Exponential - Each successive data acquisition after the average count is reached, is exponentially weighted and combined with the existing average.

Mode:	MRECEIVE
Key Path:	Meas Setup
Remote Command:	<code>[:SENSe] :MODRate :AVERage :TYPE REP EXP</code> <code>[:SENSe] :MODRate :AVERage :TYPE?</code>
Preset:	REP
State Saved:	Saved in instrument state.
Range:	Repeat Exponential
Example:	<code>:MODR:AVER:TYPE EXP</code> <code>:MODR:AVER:TYPE?</code>

4.4.7.2.4 Avg Number Sets the number that will be averaged. After the specified number (average counts) has been averaged, the averaging mode (termination control) setting determines the averaging action.

Mode:	MRECEIVE
Key Path:	Meas Setup
Remote Command:	[:SENSe] :MODRate:AVERage:COUNT <integer> [:SENSe] :MODRate:AVERage:COUNT? [:SENSe] :MODRate:AVERage [:STATe] OFF ON 0 1 [:SENSe] :MODRate:AVERage [:STATe] ?
Preset:	25, ON
State Saved:	Saved in instrument state.
Min:	1
Max:	8192
Example:	:MODR:AVER:COUN 10 :MODR:AVER:COUN? :MODR:AVER:STAT OFF :MODR:AVER:STAT?

4.4.7.2.5 Fast Mode Allows you to toggle the **Fast Mode** between **On** and **Off**. Fast Mode can speed up the measurement.

Key Path:	Meas Setup
Remote Command:	[:SENSe] :MODRate:FAST 0 1 OFF ON [:SENSe] :MODRate:FAST?
Default:	OFF
State Saved:	Saved in instrument state.
Range:	ON OFF
Example:	:MODR:FAST ON :MODR:FAST?

4.4.8 Modulation Distortion Measurement

There is only one view available for Modulation Distortion measurement.

There are two windows in this view:

- Modulation Distortion Numeric Results Window (upper)
- Modulation Distortion Settings Window (lower)

Table 4-23 Modulation Distortion Numeric Results Window

Name	Corresponding Results
Modulation Distortion	n=1, 1st Modulation Distortion
Modulation Distortion Ratio	n=1, 2nd This result will replace Modulation Distortion when Display Mode is Ratio

Table 4-24 Modulation Distortion Settings Window

Name	Corresponding Results
IF BW Type	It can be Auto, Manual or Min
IF BW	This value is the IF bandwidth set manually
Detector Selection	It can be Peak +, Peak -, Peak +/- 2 or RMS
Peak Hold	It can be On or Off
HP Filter	It can be None, 50 Hz or 300 Hz
LP Filter	It can be None, 3 kHz, 15 kHz, 30 kHz or 300 kHz
De-emphasis Filter	It can be None, 25 us, 50 us, 75 us, or 750 us

4.4.8.1 Amplitude/Y Scale

The AMPLITUDE/Y Scale key accesses the menu to set the desired vertical scale and associated settings:

Default numbers are independent for each window.

4.4.8.1.1 Display Mode Sets display mode.

Key Path: **Amplitude Y Scale**

Remote Command: :DISPlay:MODDist:MODE NORMal|RATio
 :DISPlay:MODDist:MODE?

Preset: NORMal

State Saved: Saved in instrument state.
 Range: Normal | Ratio
 Example: DISP:MODD:MODE NORM
 DISP:MODD:MODE?

4.4.8.1.2 Display Unit Sets unit for Normal display mode.

Key Path: **Amplitude Y Scale**
Remote Command: :DISPlay:MODDist:UNIT PCT|DB
 :DISPlay:MODDist:UNIT?
 Preset: PCT
 State Saved: Saved in instrument state.
 Range: %|dB
 Example: DISP:MODDist:UNIT PCT
 DISP:MODDist:UNIT?

4.4.8.1.3 Ratio Reference If AM depth is to be displayed relative to a reference, enter the value as a ratio reference using this key.

Key Path: **Amplitude Y Scale**
Remote Command: :DISPlay:MODDist:RREfERENCE <percent>
 :DISPlay:MODDist:RREfERENCE?
 :DISPlay:MODDist:RREfERENCE:AUTO 0|1|OFF|ON
 :DISPlay:MODDist:RREfERENCE:AUTO?
 Preset: 100.00
 State Saved: Saved in instrument state.
 Min: 0.01
 Max: 500.00
 Example: :DISP:MODD:RREF 100.0
 :DISP:MODD:RREF?
 :DISP:MODD:RREF:AUTO OFF
 :DISP:MODD:RREF:AUTO?

4.4.8.1.4 Ratio Mode The ratio and previous ratio functions permit any measurement result to be scaled to a reference. The reference may be either a measurement result or a keyboard entry.

The Log/Linear key enables measurement results to be displayed in linear or logarithmic units. For purposes of discussion, % for AM is treated as absolute unit. When the instrument display dB as relative unit, annunciator REL is added to the display.

Key Path:	Amplitude Y Scale
Remote Command:	:DISPlay:MODDist:RMODE LOG LINear :DISPlay:MODDist:RMODE?
Preset:	LOG
State Saved:	Saved in instrument state.
Range:	Log Linear
Example:	:DISP:MODD:RMOD LOG :DISP:MODD:RMOD?

4.4.8.2 Meas Setup

Displays the measurement setup menu for the Modulation Distortion Measurement when the Modulation Distortion **Measurement** key has been selected in the **Measure** menu.

4.4.8.2.1 IF BW Used to specify the IF BW, if the IF BW Type is set to Man.

Key Path:	Meas Setup
Remote Command:	[:SENSe]:MODDist:BANDwidth BWIDth <bandwidth> [:SENSe]:MODDist:BANDwidth BWIDth?
Preset:	1 MHz
State Saved:	Saved in instrument state.
Min:	1 kHz
Max:	10 MHZ
Example:	:MODD:BAND 200kHz :MODD:BAND?

4.4.8.2.2 IF BW Type Used to adjust the IF Bandwidth that the analyzer uses while making a modulation measurement. In this measurement, there are three BW types: Auto, Manual and Minimal. However, the parameter can be set only when Bandwidth Type is set to Manual. In Auto and Minimal types, the system determines this parameter automatically. Usually auto type is sufficient for most measurement conditions, but this parameter allows adjustment when challenging measurement conditions exist. Signals with hard to measure bandwidths, such as

low rate and high deviation FM/PM signals are an example. A value that is very close to the actual signal bandwidth should be used in this case. (If the value is too low, an inaccurate measurement reading will result, whereas a value too high will allow unwanted noise and increase measurement time, unnecessarily.) The type of IF bandwidths that the PSA uses can vary from ~25 kHz to 8 MHz.

Auto: This is the default setting. This setting causes system to perform an occupied bandwidth measurement on the modulated signal. This measurement will occur at the start of any modulation measurement, and will help determine the final IF bandwidth that the PSA will use in analyzing the signal. The main drawback of this mode is measurement throughput; extra time is required during initialization to perform the bandwidth measurement.

Manual: In this mode you can use the IF Bandwidth parameter to suggest a bandwidth for the system to use during demodulation. The actual IF bandwidth that is used will try to be greater than this value, and at a point where the PSA is optimized to produce fast, accurate results. In this mode measurement throughput is increased because initialization bandwidth measurements are bypassed. Another use of this mode is to ensure that the analyzer is behaving correctly for signals whose bandwidth is hard to measure (that is, low rate audio signals).

Minimal: This will choose the minimum IF bandwidth necessary to perform the modulation measurement. The minimum bandwidth used is determined by the Low Pass Filter setting and is a value that is $> 2 \times \text{LowPassFilter}$. This mode usually works for most signals with a low modulation index. This mode will increase measurement throughput because the analyzer can bypass the bandwidth measurement routines that are performed at initialization for the Auto mode.

Key Path:	Meas Setup
Remote Command:	[:SENSe] :MODDist :BANDwidth BWIDth :TYPE MIN AUTO MAN [:SENSe] :MODDist :BANDwidth BWIDth :TYPE?
Preset:	AUTO
State Saved:	Saved in instrument state.
Range:	Auto Man Min
Notes:	The IF BW type “Min” is meaningful only when the Modulation Mode is “AM”. For FM, PM signal, the result will not be correct with this IF BW Type.
Example:	MODD:BAND:TYPE AUTO MODD:BAND:TYPE?

4.4.8.2.3 Average Mode There are four modes which define how the average is determined.

- Repeat: Adds the values for each measurement and divides this number by the Count value.
- Exponential: Each successive data acquisition after the average count is reached is exponentially weighted and combined with the existing average. Exponential averaging weights new data more than old data, which facilitates tracking of slow-changing signals. The average will be displayed at the end of each measurement.

Key Path:	Meas Setup
Remote Command:	[:SENSE] :MODDist:AVERage:TYPE REP EXP [:SENSe] :MODDist:AVERage:TYPE?
Preset:	REP
State Saved:	Saved in instrument state.
Range:	Repeat Exponential
Example:	MODD:AVER:TYPE EXP MODD:AVER:TYPE?

4.4.8.2.4 Average Number Allows you to specify the number of measurement averages used when calculating the measurement result.

Key Path:	Meas Setup
Remote Command:	[:SENSE] :MODDist:AVERage:COUNT <integer> [:SENSe] :MODDist:AVERage:COUNT? [:SENSE] :MODDist:AVERage [:STATe] OFF ON 0 1 [:SENSe] :MODDist:AVERage [:STATe] ?
Preset:	25, ON
State Saved:	Saved in instrument state.
Min:	1
Max:	8192
Example:	:MODD:AVER:COUN 25 :MODD:AVER:STAT OFF :MODD:AVER:STAT?

4.4.8.2.5 Fast Mode Allows you to toggle the **Fast Mode** between **On** and **Off**. Fast Mode can speed up the measurement.

Key Path:	Meas Setup
Remote Command:	[:SENSe] :MODDist:FAST 0 1 OFF ON [:SENSe] :MODDist:FAST?
Default:	OFF
State Saved:	Saved in instrument state.
Range:	ON OFF
Example:	:MODD:FAST ON :MODD:FAST?

4.4.9 Modulation SINAD Measurement

There is only one view available for this measurement.

There are two windows in this view:

- Modulation SINAD Numeric Result Window (upper)
- Modulation SINAD Settings Window (lower)

Table 4-25 Modulation SINAD Numeric Results Window

Name	Corresponding Results
Modulation SINAD	n=1, 1st Modulation SINAD
Modulation SINAD Ratio	n=1, 2nd This result will replace Modulation SINAD when Display Mode is Ratio

Table 4-26 Modulation SINAD Settings Window

Name	Corresponding Results
IF BW Type	It can be Auto, Manual or Min
IF BW	This value is the IF bandwidth set manually
Detector Selection	It can be Peak +, Peak -, Peak +/- 2 or RMS
Peak Hold	It can be On or Off
HP Filter	It can be None, 50 Hz or 300 Hz
LP Filter	It can be None, 3 kHz, 15 kHz, 30 kHz or 300 kHz
De-emphasis Filter	It can be None, 25 us, 50 us, 75 us, or 750 us

4.4.9.1 Amplitude/Y Scale

The AMPLITUDE/Y Scale key accesses the menu to set the desired vertical scale and associated settings:

Default numbers are independent for each window.

4.4.9.1.1 Display Mode Sets the display mode.

Key Path:	Amplitude Y Scale
Remote Command:	:DISPlay:MODSinad:MODE NORMal RATio :DISPlay:MODSinad:MODE?
Preset:	NORMal
State Saved:	Saved in instrument state.
Range:	Normal Ratio
Example:	DISP:MODS:MODE NORM DISP:MODS:MODE?

4.4.9.1.2 Display Unit Sets the unit for Normal display mode.

Key Path:	Amplitude Y Scale
Remote Command:	:DISPlay:MODSinad:UNIT PCT DB :DISPlay:MODSinad:UNIT?
Preset:	DB
State Saved:	Saved in instrument state.
Range:	% dB
Example:	DISP:MODSinad:UNIT PCT DISP:MODSinad:UNIT?

4.4.9.1.3 Ratio Reference If AM depth is to be displayed relative to a reference, enter the value as a ratio reference using this key.

Key Path:	Amplitude Y Scale
Remote Command:	:DISPlay:MODSinad:RREFerence <rel_ampl> :DISPlay:MODSinad:RREFerence? :DISPlay:MODSinad:RREFerence:AUTO 0 1 OFF ON :DISPlay:MODSinad:RREFerence:AUTO?
Preset:	0.00 dB
State Saved:	Saved in instrument state.
Min:	0.00 dB
Max:	200.00 dB
Example:	:DISP:MODS:RREF 10 dB :DISP:MODS:RREF? :DISP:MODS:RREF:AUTO OFF :DISP:MODS:RREF:AUTO?

4.4.9.1.4 Ratio Mode The ratio and previous ratio functions permit any measurement result to be scaled to a reference. The reference may be either a measurement result or a keyboard entry.

The Log/Linear key enables measurement results to be displayed in linear or logarithmic units. For purposes of discussion, % for AM is treated as absolute unit. When the instrument display dB as relative unit, annunciator REL is added to the display.

Key Path:	Amplitude Y Scale
Remote Command:	:DISPlay:MODSinad:RMODe LOG LINear :DISPlay:MODSinad:RMODe?
Preset:	LOG
State Saved:	Saved in instrument state.
Range:	Log Linear
Example:	:DISP:MODS:RMOD LOG :DISP:MODS:RMOD?

4.4.9.2 Meas Setup

Displays the measurement setup menu for the Modulation SINAD Measurement when the Modulation SINAD **Measurement** key has been selected in the **Measure** menu.

4.4.9.2.1 IF BW Used to specify the IF BW, if the IF BW Type is set to Man.

Key Path:	Meas Setup
Remote Command:	[:SENSE] :MODSinad: BANDwidth BWIDth <bandwidth> [:SENSE] :MODSinad: BANDwidth BWIDth?
Preset:	1 MHz
State Saved:	Saved in instrument state.
Min:	1 kHz
Max:	10 MHz
Example:	:MODSinad: BAND 200kHz :MODSinad: BAND?

4.4.9.2.2 IF BW Type Used to adjust the IF Bandwidth that the analyzer uses while making a modulation measurement. In this measurement, there are three BW types: Auto, Manual and Minimal. However, the parameter can be set only when Bandwidth Type is set to Manual. In Auto and Minimal types, the system determines this parameter automatically. Usually auto mode is sufficient for most measurement conditions, but this parameter allows adjustment when challenging measurement conditions exist. Signals with hard to measure bandwidths, such as low rate and high deviation FM/PM signals are an example. A value that is very close to the actual signal bandwidth should be used in this case. (If the value is too low, an inaccurate measurement reading will result, whereas a value too high will allow unwanted noise and increase measurement time, unnecessarily.) The type of IF bandwidths that the PSA uses can vary from ~25 kHz to 8 MHz.

- **Auto:** This is the default setting. This setting causes system to perform an occupied bandwidth measurement on the modulated signal. This measurement will occur at the start of any modulation measurement, and will help determine the final IF bandwidth that the PSA will use in analyzing the signal. The main drawback of this mode is measurement throughput; extra time is required during initialization to perform the bandwidth measurement.
- **Manual:** In this mode you can use the IF Bandwidth parameter to suggest a bandwidth for the system to use during demodulation. The actual IF bandwidth that is used will try to be greater than this value, and at a point where the PSA is optimized to produce fast, accurate results. In this mode measurement throughput is increased because initialization bandwidth measurements are bypassed. Another use of this mode is to ensure that the analyzer is behaving correctly for signals whose bandwidth is hard to measure (that is, low rate audio signals).
- **Minimal:** This will choose the minimum IF bandwidth necessary to perform the modulation

Measurement keys

measurement. The minimum bandwidth used is determined by the Low Pass Filter setting and is a value that is $> 2 \times \text{LowPassFilter}$. This mode usually works for most signals with a low modulation index. This mode will increase measurement throughput because the analyzer can bypass the bandwidth measurement routines that are performed at initialization for the Auto mode.

Key Path:	Meas Setup
Remote Command:	<code>[:SENSE] :MODSinad :BANDwidth BWIDth :TYPE MIN AUTO MAN</code> <code>[:SENSE] :MODSinad :BANDwidth BWIDth :TYPE ?</code>
Preset:	AUTO
State Saved:	Saved in instrument state.
Range:	Auto Man Min
Notes:	The IF BW type “Min” is meaningful only when the Modulation Mode is “AM”. For FM, PM signal, the result will not be correct with this IF BW Type.
Example:	<code>AUDSinad :BAND :TYPE AUTO</code> <code>AUDSinad :BAND :TYPE ?</code>

4.4.9.2.3 Average Number Allows you to specify the number of measurement averages used when calculating the measurement result.

Key Path:	Meas Setup
Remote Command:	<code>[:SENSE] :MODSinad :AVERage :COUNT <integer></code> <code>[:SENSE] :MODSinad :AVERage :COUNT ?</code> <code>[:SENSE] :MODSinad :AVERage [:STATE] OFF ON 0 1</code> <code>[:SENSE] :MODSinad :AVERage [:STATE] ?</code>
Preset:	25, ON
State Saved:	Saved in instrument state.
Min:	1
Max:	8192
Example:	<code>:MODSinad :AVERage :COUNT 25</code> <code>:MODS :AVER :STAT OFF</code> <code>:MODS :AVER :STAT ?</code>

4.4.9.2.4 Average Mode There are four modes which define how the average is determined.

- **Repeat:** Adds the values for each measurement and divides this number by the Count value.
- **Exponential:** Each successive data acquisition after the average count is reached is exponentially weighted and combined with the existing average. Exponential averaging weights new data more than old data, which facilitates tracking of slow-changing signals. The average will be displayed at the end of each measurement.

Key Path:	Meas Setup
Remote Command:	[:SENSE] :MODSinad:AVERAge:TYPE REP EXP [:SENSE] :MODSinad:AVERAge:TYPE?
Preset:	REP
State Saved:	Saved in instrument state.
Range:	Repeat Exponential
Example:	AUDSinad:AVERAge:TYPE EXP AUDSinad:AVERAge:TYPE?

4.4.10 Audio Frequency Measurement

There is only one view available for this measurement.

- - Audio Frequency Numeric Results Window (upper)
- - Audio Frequency Settings Window (lower)

Table 4-27 Audio Frequency Numeric Results Window

Name	Corresponding Results
Audio Frequency	n=1, 1st

Table 4-28 Audio Frequency Settings Window

Name	Corresponding Results
Ratio Reference	It is the reference value for Ratio mode
Ratio Mode	It can be Log or Linear
Detector Selection	It can be Peak +, Peak -, Peak +/- 2 or RMS
Peak Hold	It can be On or Off
HP Filter	It can be None, 50 Hz or 300 Hz
LP Filter	It can be None, 3 kHz, 15 kHz, 30 kHz or 300 kHz

4.4.10.1 Amplitude/Y Scale

The AMPLITUDE/Y Scale key accesses the menu to set the desired vertical scale and associated settings:

Default numbers are independent for each window.

4.4.10.1.1 Display Mode Sets the display mode.

Mode: MRECEIVE

Key Path: **Amplitude/Y Scale**

Remote Command: :DISPlay:AUDFreq:MODE NORMal|RATio
 :DISPlay:AUDFreq:MODE?

Preset: NORMal

State Saved: Saved in instrument state.

Range: Normal | Ratio

Dependencies/Couplings: No

Example: :DISP:AUDF:MODE NORM
 :DISP:AUDF:MODE?

4.4.10.1.2 Display Unit Sets unit for Normal display mode.

Mode:	MRECEIVE
Key Path:	Amplitude/Y Scale
Remote Command:	:DISPlay:AUDFreq:UNIT HZ KHZ :DISPlay:AUDFreq:UNIT?
Preset:	HZ
State Saved:	Saved in instrument state.
Range:	Hz kHz
Example:	:DISP:AUDF:UNIT KHZ :DISP:AUDF:UNIT?

4.4.10.1.3 Ratio Reference If Frequency is to be displayed relative to a reference, enter the value as a ratio reference using this key.

Mode:	MRECEIVE
Key Path:	Amplitude/Y Scale
Remote Command:	:DISPlay:AUDFreq:RREference <freq> :DISPlay:AUDFreq:RREference? :DISPlay:AUDFreq:RREference:AUTO 0 1 OFF ON :DISPlay:AUDFreq:RREference:AUTO?
Unit:	Hz kHz
Preset:	400 Hz
State Saved:	Saved in instrument state.
Min:	20 Hz
Max:	500 kHz
Dependencies/Couplings:	No
Example:	:DISP:AUDF:RREF 400 Hz :DISP:AUDF:RREF? :DISP:AUDF:RREF:AUTO OFF :DISP:AUDF:RREF:AUTO?

4.4.10.1.4 Ratio Mode The ratio and previous ratio functions permit any measurement result to be scaled to a reference. The reference may be either a measurement result or a keyboard entry. The Log/Linear key enables measurement results to be displayed in linear or logarithmic units.

Mode:	MRECEIVE
Key Path:	Amplitude/Y Scale
Remote Command:	:DISPlay:AUDFreq:RMODe LOG LINear :DISPlay:AUDFreq:RMODe?
Preset:	LOG
State Saved:	Saved in instrument state.
Range:	Log Linear
Dependencies/Couplings:	No
Example:	:DISP:AUDF:RMOD LOG :DISP:AUDF:RMOD?

4.4.10.2 Meas Setup

Displays the measurement setup menu for the Audio Frequency Measurement when the **Audio Frequency** key has been selected in the **Measure** menu.

4.4.10.2.1 Avg Mode Selects the type of termination control used for averaging. This determines the averaging action after the specified number of average count is reached.

- Repeat - After reaching the average count, the averaging is reset and a new average is started
- Exponential - Each successive data acquisition after the average count is reached, is exponentially weighted and combined with the existing average.

Mode:	MRECEIVE
Key Path:	Meas Setup
Remote Command:	[:SENSe] :AUDFreq:AVERage:TYPE REP EXP [:SENSe] :AUDFreq:AVERage:TYPE?
Preset:	REP
State Saved:	Saved in instrument state.
Range:	Repeat Exponential
Example:	:AUDF:AVER:TYPE EXP :AUDF:AVER:TYPE?

4.4.10.2.2 Avg Number Sets the number that will be averaged. After the specified number (average counts) has been averaged, the averaging mode (termination control) setting determines the averaging action.

Mode: MRECEIVE

Key Path: **Meas Setup**

Remote Command: [:SENSe]:AUDFreq:AVERage:COUNT <integer>
[:SENSe]:AUDFreq:AVERage:COUNT?
[:SENSe]:AUDFreq:AVERage[:STATe] OFF|ON|0|1
[:SENSe]:AUDFreq:AVERage[:STATe]?

Preset: 25, ON

State Saved: Saved in instrument state.

Min: 1

Max: 8192

Example: :AUDF:AVER:COUN 10
:AUDF:AVER:COUN?
:AUDF:AVER:STAT OFF
:AUDF:AVER:STAT?

4.4.11 Audio AC Level Measurement

There is only one view available for Audio AC Level measurement. There are two windows in this view:

- Audio AC Level Numeric Results Window
- Audio AC Level Settings Window

Table 4-29 Audio AC Level Numeric Results Window

Name	Corresponding Results
Audio AC Level	n=1 1st

Table 4-30 Audio AC Level Settings Window

Name	Corresponding Results
Detector Selection	It can be RMS
Peak Hold	It can be On or Off
HP Filter	It can be None, 50 Hz or 300 Hz
LP Filter	It can be None, 3 kHz, 15 kHz, 30 kHz or 300 kHz

4.4.11.1 AMPLITUDE/Y Scale

The AMPLITUDE/Y Scale key accesses the menu to set the desired vertical scale and associated settings:

Default numbers are independent for each window.

4.4.11.1.1 Display Mode If measurement results are to be displayed relative to a reference, enter the value as a ratio reference by selecting **RATIO**.

Key Path:	Amplitude/Y Scale
Remote Command:	:DISPlay:AUDLevel:MODE NORMal RATio :DISPlay:AUDLevel:MODE?
Preset:	NORMal
State Saved:	Saved in instrument state.
Range:	Normal Ratio
Example:	:DISP:AUDL:MODE NORM :DISP:AUDL:MODE?

4.4.11.1.2 Display Unit

Key Path:	Amplitude/Y Scale
Remote Command:	:DISPlay:AUDLevel:UNIT V MV UV :DISPlay:AUDLevel:UNIT?
Preset:	V
State Saved:	Saved in instrument state.
Range:	V mV uV
Example:	:DISP:AUDL:UNIT V :DISP:AUDL:UNIT?

4.4.11.1.3 Ratio Reference If audio AC level is to be displayed relative to a reference, enter the value as a ratio reference using this key.

Key Path:	Amplitude/Y Scale
Remote Command:	:DISPlay:AUDLevel:RREference <real> :DISPlay:AUDLevel:RREference? :DISPlay:AUDLevel:RREference:AUTO 0 1 OFF ON :DISPlay:AUDLevel:RREference:AUTO?
Preset:	100mV
State Saved:	Saved in instrument state.
Min:	1mV
Max:	20V
Example:	:DISP:AUDL:RREF 100mV :DISP:AUDL:RREF? :DISP:AUDL:RREF:AUTO OFF :DISP:AUDL:RREF:AUTO?

4.4.11.1.4 Ratio Mode The ratio and previous ratio functions permit any measurement result to be scaled to a reference. The reference may be either a measurement result or a keyboard entry. The Log/Linear key enables measurement results to be displayed in linear or logarithmic units. In the Ratio mode, measurements are made in the same way as when not in the Ratio mode. However, before the result is displayed, the internal controller converts it to ratio. The following equations are used for computing ratio:

$$(M/R) * 100 \% = \% \text{ ratio for linear display,}$$

$$20 * \log (M/R) = \text{dB ratio for logarithmic display,}$$

where M is the measurement result and R is the ratio reference.

Key Path:	Amplitude/Y Scale
Remote Command:	:DISPlay:AUDLevel:RMODE LOG LINear :DISPlay:AUDLevel:RMODE?
Preset:	LOG
State Saved:	Saved in instrument state.
Range:	Log Linear
Example:	:DISP:AUDL:RMOD LOG :DISP:AUDL:RMOD?

4.4.11.2 Meas Setup

Displays the measurement setup menu for the Audio AC Level Measurement when the Audio AC Level **Measurement** key has been selected in the **Measure** menu.

4.4.11.2.1 Average Mode Selects the type of termination control used for averaging. This determines the averaging action after the specified number of frames (average count) is reached.

Exponential - Each successive data acquisition after the average count is reached, is exponentially weighted and combined with the existing average.

Repeat - After reaching the average count, the averaging is reset and a new average is started.

Key Path:	Meas Setup
Remote Command:	[:SENSe] :AUDLevel :AVERage:TYPE REP EXP [:SENSe] :AUDLevel :AVERage:TYPE?
Preset:	REP
State Saved:	Saved in instrument state.
Range:	Repeat Exponential
Example:	:AUDL:AVER:TYPE EXP :AUDL:AVER:TYPE?

4.4.11.2.2 Average Number Sets the number that will be averaged. After the specified number (average counts) have been averaged, the averaging mode (termination control) setting determines the averaging action.

Key Path:	Meas Setup
Remote Command:	[:SENSe]:AUDLevel:AVERage:COUNt <integer> [:SENSe]:AUDLevel:AVERage:COUNt? [:SENSe]:AUDLevel:AVERage[:STATe] OFF ON 0 1 [:SENSe]:AUDLevel:AVERage[:STATe]?
Preset:	25, ON
State Saved:	Saved in instrument state.
Min:	1
Max:	8192
Example:	:AUDL:AVER:COUN 25 :AUDL:AVER:COUN? :AUDL:AVER:STAT OFF :AUDL:AVER:STAT?

4.4.12 Audio Distortion Measurement

There is only one view available for this measurement.

There are two windows in this view:

- Audio Distortion Numeric Results Window (upper)
- Audio Distortion Settings Window (lower)

Table 4-31 Audio Distortion Numeric Results Window

Name	Corresponding Results
Audio Distortion	n=1, 1st Audio Distortion
Audio Distortion Ratio	n=1, 2nd This result will replace Audio Distortion when Display Mode is Ratio

Table 4-32 Audio Distortion Settings Window

Name	Corresponding Results
Average Mode	It can be Off, Repeat, Exponential or Peak Hold
Average Count	It is the number of averages
Display Mode	It can be Normal or Ratio
Ratio Reference	It is the reference value for Ratio mode
Ratio Mode	It can be Log or Linear
Detector Selection	It can be Peak +, Peak -, Peak +/- 2 or RMS
Peak Hold	It can be On or Off
HP Filter	It can be None, 50 Hz or 300 Hz
LP Filter	It can be None, 3 kHz, 15 kHz, 30 kHz or 300 kHz

4.4.12.1 Amplitude/Y Scale

The AMPLITUDE/Y Scale key accesses the menu to set the desired vertical scale and associated settings:

Default numbers are independent for each window.

4.4.12.1.1 Display Mode Sets display mode.

Key Path:	Amplitude/Y Scale
Remote Command:	:DISPlay:AUDDist:MODE NORMal RATio :DISPlay:AUDDist:MODE?
Preset:	NORMal
State Saved:	Saved in instrument state.
Range:	Normal Ratio
Example:	DISP:AUDD:MODE NORM DISP:AUDD:MODE?

4.4.12.1.2 Display Unit Sets unit for Normal display mode.

Key Path:	Amplitude/Y Scale
Remote Command:	:DISPlay:AUDDist:UNIT PCT DB :DISPlay:AUDDist:UNIT?
Preset:	PCT
State Saved:	Saved in instrument state.
Range:	% dB
Example:	DISP:AUDDist:UNIT PCT DISP:AUDDist:UNIT?

4.4.12.1.3 Ratio Reference If AM depth is to be displayed relative to a reference, enter the value as a ratio reference using this key.

Key Path:	Amplitude/Y Scale
Remote Command:	:DISPlay:AUDDist:RREFerence <percent> :DISPlay:AUDDist:RREFerence? :DISPlay:AUDDist:RREFerence:AUTO 0 1 OFF ON :DISPlay:AUDDist:RREFerence:AUTO?
Preset:	100.00
State Saved:	Saved in instrument state.
Min:	0.01
Max:	500.00
Example:	:DISP:AUDD:RREF 100.0 :DISP:AUDD:RREF? :DISP:AUDD:RREF:AUTO OFF :DISP:AUDD:RREF:AUTO?

4.4.12.1.4 Ratio Mode The ratio and previous ratio functions permit any measurement result to be scaled to a reference. The reference may be either a measurement result or a keyboard entry.

The Log/Linear key enables measurement results to be displayed in linear or logarithmic units. For purposes of discussion, % for AM is treated as absolute unit. When the instrument display dB as relative unit, annunciator REL is added to the display.

Key Path:	Amplitude/Y Scale
Remote Command:	:DISPlay:AUDDist:RMODE LOG LINear :DISPlay:AUDDist:RMODE?
Preset:	LOG
State Saved:	Saved in instrument state.
Range:	Log Linear
Example:	:DISP:AUDD:RMOD LOG :DISP:AUDD:RMOD?

4.4.12.2 Meas Setup

Displays the measurement setup menu for the Audio Distortion Measurement when the Audio Distortion **Measurement** key has been selected in the **Measure** menu.

4.4.12.2.1 Average Number Allows you to specify the number of measurement averages used when calculating the measurement result.

Key Path:	Meas Setup
Remote Command:	[:SENSE] :AUDDist:AVERage:COUNT <integer> [:SENSE] :AUDDist:AVERage:COUNT? [:SENSE] :AUDDist:AVERage [:STATe] OFF ON 0 1 [:SENSE] :AUDDist:AVERage [:STATe] ?
Preset:	25, ON
State Saved:	Saved in instrument state.
Min:	1
Max:	8192
Example:	:AUDD:AVER:COUN 25 :AUDD:AVER:COUN? :AUDD:AVER:STAT OFF :AUDD:AVER:STAT?

4.4.12.2.2 Average Mode There are four modes which define how the average is determined.

- Repeat: Adds the values for each measurement and divides this number by the Count value.
- Exponential: Each successive data acquisition after the average count is reached is exponentially weighted and combined with the existing average. Exponential averaging weights new data more than old data, which facilitates tracking of slow-changing signals. The average will be displayed at the end of each measurement.

Key Path:	Meas Setup
Remote Command:	[:SENSE] :AUDDist:AVERage:TYPE REP EXP [:SENSE] :AUDDist:AVERage:TYPE?
Preset:	REP
State Saved:	Saved in instrument state.
Range:	Normal Exponential
Example:	AUDDist:AVERage:TYPE EXP AUDDist:AVERage:TYPE?

4.4.13 Audio SINAD Measurement

There is only one view available for this measurement.

There are two windows in this view:

- Audio SINAD Numeric Results Window (upper)
- Audio SINAD Settings Window (lower)

Table 4-33 Audio SINAD Numeric Results Window

Name	Corresponding Results
Audio SINAD	n=1,1st Audio SINAD
Audio SINAD Ratio	n=1, 2nd This result will replace Audio SINAD when Display Mode is Ratio

Table 4-34 Audio SINAD Settings Window

Name	Corresponding Results
Detector Selection	It can be Peak +, Peak -, Peak +/- 2 or RMS
Peak Hold	It can be On or Off
HP Filter	It can be None, 50 Hz or 300 Hz
LP Filter	It can be None, 3 kHz, 15 kHz, 30 kHz or 300 kHz

4.4.13.1 Amplitude/Y Scale

The AMPLITUDE/Y Scale key accesses the menu to set the desired vertical scale and associated settings:

Default numbers are independent for each window.

Audio SINAD Settings window does not have this menu (Blank menu).

4.4.13.1.1 Display Mode Sets the display mode.

Key Path:	Amplitude/Y Scale
Remote Command:	:DISPlay:AUDSinad:MODE NORMal RATio :DISPlay:AUDSinad:MODE?
Preset:	NORMal
State Saved:	Saved in instrument state.
Range:	Normal Ratio
Example:	DISP:AUDS:MODE NORM DISP:AUDS:MODE?

4.4.13.1.2 Display Unit Sets the unit for Normal display mode.

Key Path:	Amplitude/Y Scale
Remote Command:	:DISPlay:AUDSinad:UNIT PCT DB :DISPlay:AUDSinad:UNIT?
Preset:	DB
State Saved:	Saved in instrument state.
Range:	% dB
Example:	DISP:AUDSinad:UNIT PCT DISP:AUDSinad:UNIT?

4.4.13.1.3 Ratio Reference If audio SINAD is to be displayed relative to a reference, enter the value as a ratio reference using this key.

Key Path:	Amplitude/Y Scale
Remote Command:	:DISPlay:AUDSinad:RREference <rel_ampl> :DISPlay:AUDSinad:RREference? :DISPlay:AUDSinad:RREference:AUTO 0 1 OFF ON :DISPlay:AUDSinad:RREference:AUTO?
Preset:	0.00 dB
State Saved:	Saved in instrument state.
Min:	0.00 dB
Max:	200.00 dB
Example:	:DISP:AUDS:RREF 10 dB :DISP:AUDS:RREF? :DISP:AUDS:RREF:AUTO OFF :DISP:AUDS:RREF:AUTO?

4.4.13.1.4 Ratio Mode The ratio and previous ratio functions permit any measurement result to be scaled to a reference. The reference may be either a measurement result or a keyboard entry.

The Log/Linear key enables measurement results to be displayed in linear or logarithmic units. For purposes of discussion, % for AM is treated as absolute unit. When the instrument display dB as relative unit, annunciator REL is added to the display.

Key Path:	Amplitude/Y Scale
Remote Command:	:DISPlay:AUDSinad:RMODe LOG LInear :DISPlay:AUDSinad:RMODe?
Preset:	LOG
State Saved:	Saved in instrument state.
Range:	Log Linear
Example:	:DISP:AUDS:RMOD LOG :DISP:AUDS:RMOD?

4.4.13.2 Meas Setup

Displays the measurement setup menu for the Audio SINAD Measurement when the Audio SINAD **Measurement** key has been selected in the **Measure** menu.

4.4.13.2.1 Average Number Allows you to specify the number of measurement averages used when calculating the measurement result.

Key Path:	Meas Setup
Remote Command:	[:SENSE] :AUDSinad:AVERage:COUNT <integer> [:SENSE] :AUDSinad:AVERage:COUNT? [:SENSE] :AUDSinad:AVERage [:STATe] OFF ON 0 1 [:SENSE] :AUDSinad:AVERage [:STATe] ?
Preset:	25, ON
State Saved:	Saved in instrument state.
Min:	1
Max:	8192
Example:	:AUDS:AVER:COUN 25 :AUDS:AVER:COUN? :AUDS:AVER:STAT OFF :AUDS:AVER:STAT?

4.4.13.2.2 Average Mode There are four modes which define how the average is determined.

- **Repeat:** Adds the values for each measurement and divides this number by the Count value.
- **Exponential:** Each successive data acquisition after the average count is reached is exponentially weighted and combined with the existing average. Exponential averaging weights new data more than old data, which facilitates tracking of slow-changing signals. The average will be displayed at the end of each measurement.

Key Path:	Meas Setup
Remote Command:	[:SENSE] :AUDSinad:AVERage:TYPE REP EXP [:SENSE] :AUDSinad:AVERage:TYPE?
Preset:	REP
State Saved:	Saved in instrument state.
Range:	Repeat Exponential
Example:	:AUDS:AVER:TYPE EXP :AUDS:AVER:TYPE?

5**Concepts**

This chapter provides concepts pertaining to the N5531S Measuring Receiver System, signal modulation, and explains how the various measurements are performed by the system. A list of related Agilent documents are referenced for further information.

N5531S Block Diagram

A block diagram of the N5531S Measuring Receiver System is shown below.

The system may consist of:

1. PSA Series Spectrum analyzer (PSA) (For specifications, refer to [Table 2-1 on page 37.](#))
2. P-Series Power Meter (For specifications, refer to [Table 2-2 on page 37.](#))
3. N5532A Sensor Module (For specifications, refer to [Table 2-3 on page 38.](#))
4. Optional: Personal computer (PC) running the Measuring Receiver PC Software (For specifications, refer to [Table 7-2 on page 358](#) and [Table 7-3 on page 358.](#))

Figure 5-1 N5531S Block Diagram

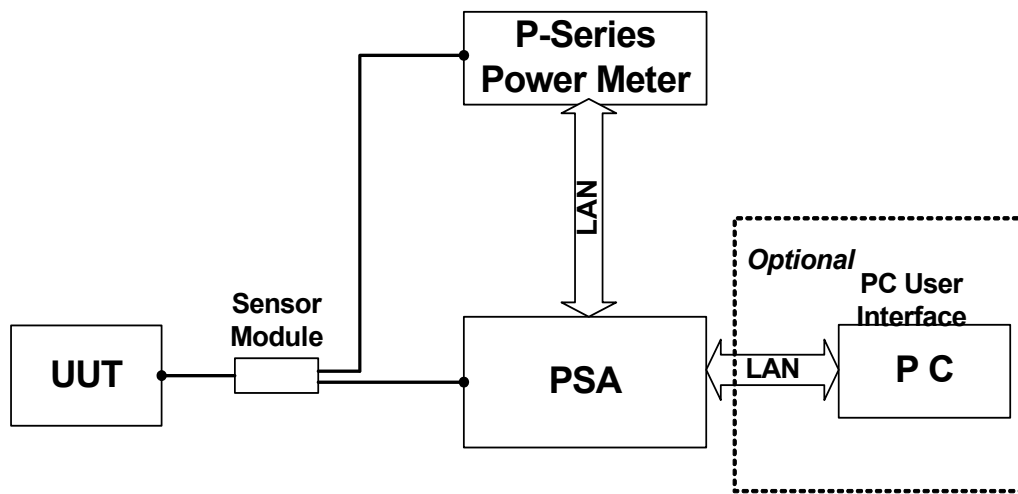

The N5532A Sensor Module receives the incoming signal from the UUT and splits it between the Power Meter and PSA. RF Power is measured by the Power Meter, whereas all other measurements are performed using the PSA.

Frequency Counter Measurements Concepts

Purpose

Frequency Counter measurement is fundamental to characterization of all signal generators that have periodic RF/microwave outputs. Frequency Counter measurements are used to accurately tune to and measure the carrier frequency of the signal. The Frequency Counter measurement and its result are the fundamental to all of the other measurements in the Measure Receiver System.

Measurement Technique

In automatic operation, the Frequency Counter automatically adjusts attenuation as the input level changes.

The frequency counter can accurately measure the carrier frequency by searching the full span of the spectrum analyzer as follows:

1. RBW 1 kHz is used for searching through the signal range from 1 kHz to 1 MHz with DC coupling.
2. RBW 10 kHz is used for searching through 1 MHz to 100 MHz with DC coupling.
3. RBW 3 MHz is used for searching above 100 MHz with AC coupling for PSA models E4440A, E443A, E4445A with DC coupling for PSA models E4446A, E4447A, E4448A (these models don't support AC coupling). Using these settings, the PSA can find signals above 100 MHz for all supported PSA models.
4. When the PSA finds a signal, the PSA searches the span= $106 \times \text{RBW}$ and uses marker frequency counter to assure the resolution. RBW can be set from the front panel. The default setting is 1 kHz.

The default gate time of 100ms is long enough to make the counter resolution as low as 0.001Hz. For E4440A, E4443A, E4445A models, if the PSA fails to find a signal through 1 kHz to 100 MHz, the PSA will try AC coupling from 100 MHz above. The PSA never goes back to DC coupling even though the frequency is re-tuned to below 100MHz in order to protect the switch.

For FM/PM modulated measurements, you should turn off the modulation and measure the carrier frequency first and then turn on the modulation and make other modulation measurement. For AM modulated measurement, it is also recommended to first turn off the modulation when measuring the Frequency Counter. If the AM modulation is not turned off, make sure that the RBW setting lower than the Modulation Rate.

The result of Frequency Error can be used to measure the frequency drift of input signals, or to compare input frequencies against a keyboard-entered reference.

RF Power Measurement Concepts

Purpose

RF Power quantifies the output level, in an absolute term, of a signal generator or an attenuator being calibrated. This is a common measurement for broadband RF/microwave signals.

The RF Power Measurement is used to accurately measure the RMS RF power of the signal by using the power meter with a sensor module. Absolute level accuracy and sensitivity are determined by the particular power sensor selected and the SWR (Standing Wave Ratio) of the signal source.

Measurement Technique

RF Power measurements uses an external power meter with a sensor module to measure the RMS power of the RF input signal. The frequency of the RF input signal is automatically measured by the Frequency Counter measurement, then the appropriate Cal Factor is obtained from the stored Cal Factor File and automatically applied to the power meter data.

The corrected power measurement data is then converted to the units selected and final result is displayed on the PSA or your PC monitor. When using the IVI-COM API or SCPI commands, the result is available for remote query.

The calibration procedure allows the system to set the power-measurement transfer function so the displayed power correctly represents the actual power. This procedure can be visualized as a process that adjusts the intercept and slope of the sensor's transfer function. The displayed power is given by the equation:

Equation 5-1

$$P_{dis} = mP_{act} + b$$

where:

P_{dis} = Displayed Power,

P_{act} = Actual Power,

b = zero crossing, and

m = slope.

The calibration routine forces b = 0 and m = 1.

The following example shows the different responses that occur during

calibration:

Figure 5-2 Simplified Block Diagram of RF Power Calibration

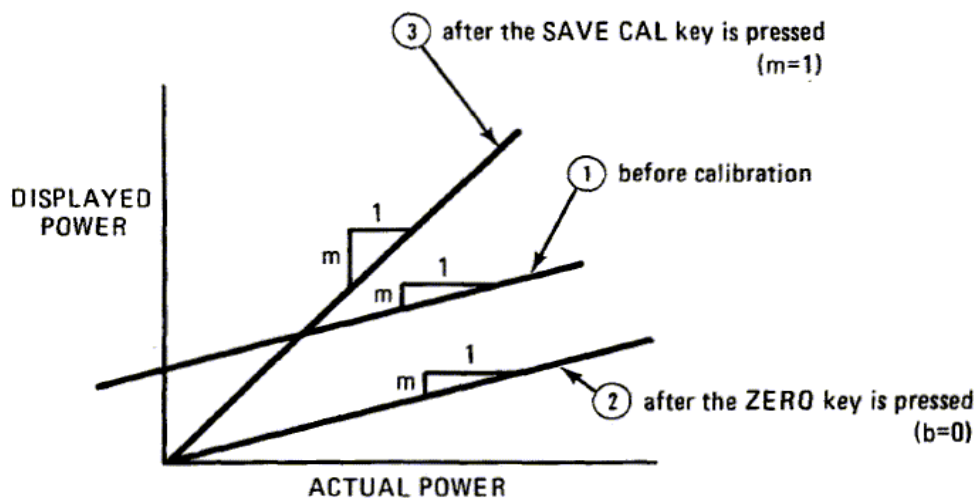

Minor adjustments in the slope are made, based on the calibration factors, to correct for variations in the power sensor's sensitivity due to frequency and mismatch.

Tuned RF Level Measurement Concepts

Purpose

Unlike RF Power measurements which measure total power across a wide frequency band, Tuned RF Level measurements tune to the frequency in interest and are capable of measuring extremely low levels of power. This is particularly useful when a step attenuator or a signal generator is tested for step accuracy of power output with incremental changes.

The Measuring Receiver System can accurately measure the absolute or relative power of low level, continuous wave (CW), RF signals. At each measurement frequency, the instrument must be calibrated to correct for frequency-dependent measurement variations.

Calibration over the full dynamic range requires calibration at three different levels. The calibration remains valid for any CW signal at that frequency +/- 5% (or above 100 MHz +/- 5 MHz, whichever is smaller).

Measurement Technique

Two ways of making ranging calibration are supported: automatic ranging calibration and manual ranging calibration, which have different calibration procedures.

1. Automatic ranging calibration

With automatic ranging calibration, the Measuring Receiver can make automatic ranging calibration without manual intervention. The Measuring Receiver will perform ranging calibration automatically depending on the SNR of input RF signal; if SNR is lower than 35 dB, the Measuring Receiver will perform a range-to-range calibration.

2. Manual ranging calibration

With manual ranging calibration, the Measuring Receiver performs ranging calibration with manual intervention manually, depending on the input RF signal level and the signal frequency. If the power of the signal of interest is close to a range calibration level, the Measuring Receiver will perform a range-to-range calibration by displaying the "Recal" indicator. The calibration must be initiated by pressing **TRFL Cal**.

Power Calibration

An initial absolute power level calibration is made by applying a signal to the Measuring Receiver via a calibrated sensor module. The signal must be within both the sensor module's and Measuring Receiver's

power and frequency range. The absolute power is first measured by Power Meter and stored as the reference level. Then PSA makes a power measurement at the same frequency. The input signal level must not change during this re-calibration. The signal level must be constant during the calibration. Then the two levels (reference level and PSA level) are compared to get a ratio (noted as CF1, Cal Factor for Range1). The ratio of the two measurements is stored as a calibration factor.

First RF Input Ranging Calibration

When the power of the input signal is lowered to the 2nd range (which varies by different frequency band in the PSA), the Measuring Receiver creates a second calibration factor (as CF2, Cal Factor for Range2) by comparing the power level measured before and after the range changes. (The input signal level must not change during this recalibration.) This new calibration factor CF2 is multiplied by the calibration factor CF1 made previously (with the reference) to be used in all subsequent measurements in RF range2 at that frequency.

Table 5-1 SNR vs. PSA Ranging

Frequency Bands	IF BW 75 Hz		IF BW 10 Hz	
	SNR (dB)	PSA Attenuator (dB)	SNR (dB)	PSA Attenuator (dB)
100 kHz - 3.05 GHz	45	10	45	10
3.05 GHz - 6.6 GHz	45	10	45	10
6.6 GHz - 13.2 GHz	45	10	45	10
13.2 GHz - 19.2 GHz	45	10	45	10
19.2 GHz - 26.5 GHz	45	4	45	10
26.5 GHz - 31.1GHz	45	4	45	4
31.1 GHz - 41 GHz	40	4	45	4
41 GHz - 50.0 GHz	30	4	30	4

- When IFBW = 10Hz, once SNR < 10dB, IFBW will be set to 1 Hz automatically in order to measure lower levels.
- If 110 option is detected, Preamp is always set to OFF in range 3 while center frequency is from 100KHz to 10MHz.
- While N5532A is connected:
When initial source power >+16dBm, Preamp is always set to OFF in range 3;
When initial source power < +16dBm, Preamp is always set to ON in range 3.

- Range 3 attenuator is fixed at 4 dB.

Second RF Input Ranging Calibration

When the power level of the input signal is lowered to the 3rd range (which varies by different frequency band in the PSA), the Measuring Receiver creates a third calibration factor (as CF3, Cal Factor for Range3) by comparing the power level measured before and after the range changes. The input signal level must not change during this recalibration. This new calibration factor CF3 is multiplied by the calibration factor CF2, and C1 made previously (with the reference) to be used in all subsequent measurements in RF range3 at that frequency.

Calibrating the Calibrated Level

From above, two Cal factors can be obtained for three ranges, range1, range2 and range3 as CF1, CF2 and CF3 (linear unit instead of dB). If let P1, P2 and P3 (linear unit instead of dBm) be the levels for range1, range2 and range3 from PSA separately, the P is the actual power, we have:

$$P = P1 * CF1, \text{ If } P1 \text{ is in range1}$$

$$P = P2 * CF1 * CF2, \text{ If } P2 \text{ is in range2}$$

$$P = P3 * CF1 * CF2 * CF3, \text{ If } P3 \text{ is in range3}$$

Figure 5-3 TRFL Ranging Calibration

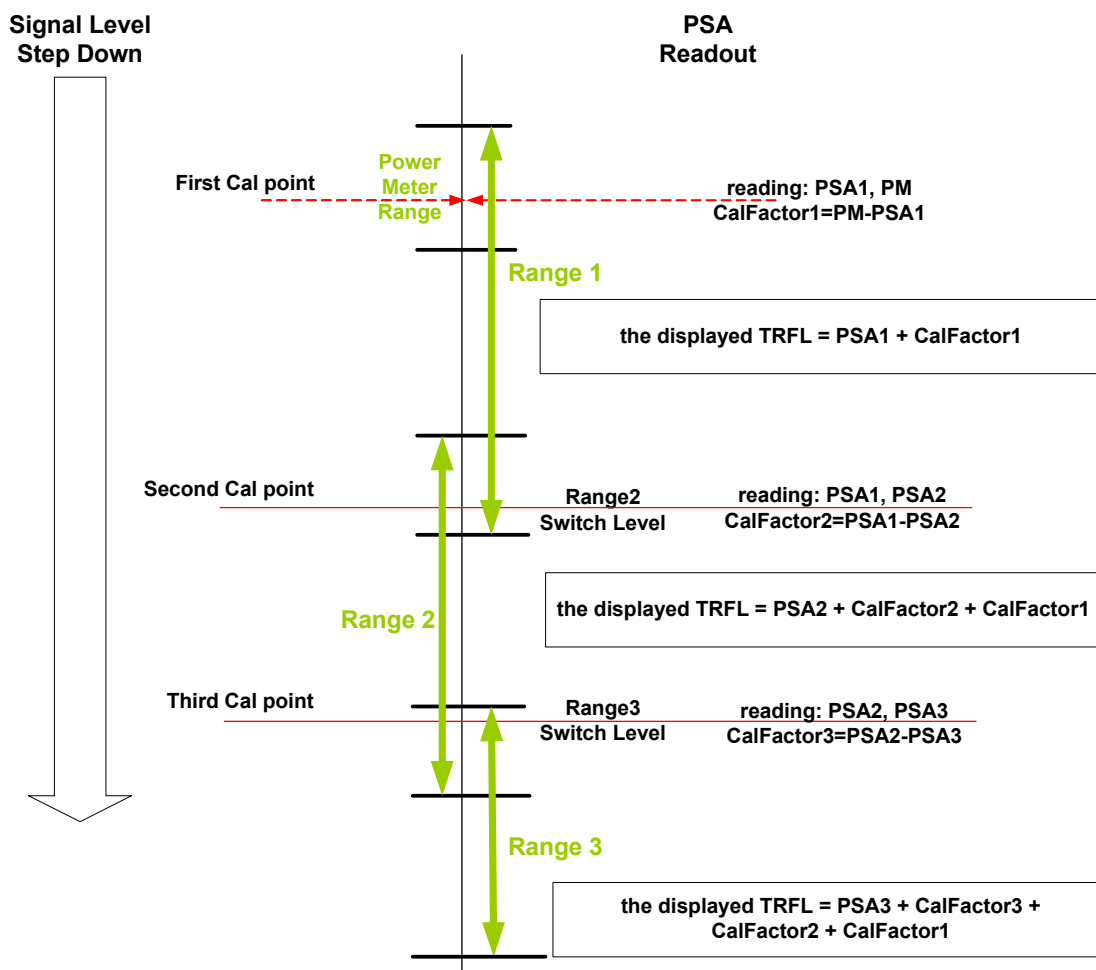

Calibration Factors

An individual calibration factor is computed for each RF range-to-range change by comparing the level measured during the initial power sensor calibration to the level measured for each RF range. This individual level measurements are ratioed to determine the relative, range-to-range calibration factors actually used in Tuned RF Level measurements.

The following table describes the equations used to calculate the ratioed calibration factors using individual calibration factors.

In this table, the Power Reference Range is the range used for initial calibration to the power sensor, and CF1, CF2 and CF3 are the "individual" calibration factor values for the range reference to 1, 2, or 3

(respectively)

Table 5-2 Table of Calibration Factors

Power Reference Range	Current Range		
	1	2	3
1	CF1	CF1 CF2	CF1 CF2 CF3
2	CF2/CF1	CF2	CF2 CF3
3	CF3/ CF2/CF1	CF3/CF2	CF3

If no actual calibration factors are available, an approximate calibration factor (accurate within a few dB) is derived.

Requirements for the Tuned RF Level Measurement

1. The Power Meter and Sensor must be calibrated.

The accuracy of the Tuned RF Level measurement depends on a calibrated RF Power measurement made with an external power sensor.

2. The PSA must be properly tuned.

The PSA must be tuned manually to the DUT frequency. Press **Frequency** and enter the DUT frequency.

3. The Tuned RF Level calibration factors for the frequency being measured must be in place or obtained during the TRFL measurement. See [“PSA Range Calibration” on page 52](#).

Up to three calibration factors will be created.

Each individual calibration factor is tagged with the frequency at which it is valid, the IF BW setting, and the Accuracy (Normal/High) setting. If any of these conditions change, the calibration factor becomes invalid.

File Operations

See [“File Operations”, on page 50](#).

Analog Modulation Concepts

Modulation Basics

The Measuring Receiver can demodulate and measure three types of modulation: amplitude modulation (AM), frequency modulation (FM), and phase modulation (ΦM). In general, modulation is that characteristic of a signal which conveys the information. A signal without modulation is said to be a continuous-wave (CW) signal. CW signals contain two information-carrying parameters: amplitude and frequency. These two parameters, however, are static (time invariant). Consequently, the information conveyed by them is scant - you know only that a signal is present at a certain frequency. When one or both of these parameters is altered as a function of time, the signals is said to be modulated.

The RF signal which is modulated is called the carrier. The modulating signal is referred to as the baseband signal and can be of any arbitrary form (for example, voice, tone, noise). Demodulation is the process of recovering the baseband signal from the modulated carrier.

Amplitude Modulation

As the name implies, a carrier is amplitude modulated when its amplitude is varied as a function of time. [Figure 5-4 on page 277](#) shows a carrier with amplitude modulation and, for reference, also shows the baseband signal. As you can see, the tips of the carrier trace out a waveform that resembles the baseband signal. This trace is called the envelope. The envelope rises to a maximum called the peak and drops to minimum called trough.

A quantity which describes the amount of AM or the AM depth is the modulation index. If the peak amplitude is called P and the trough amplitude is called T, the modulation index m (usually expressed in %) is defined as

$$m = (P-T)/(P+T)*100\%$$

Figure 5-4 Baseband Signal and the Corresponding Amplitude Modulated Carrier

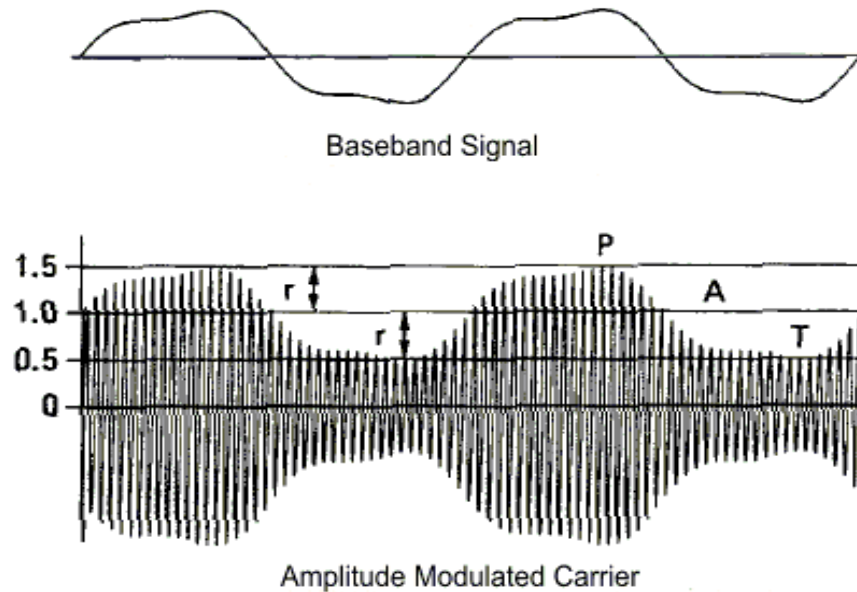

In the example of [Figure 5-4 on page 277](#), $P = 1.5$ and $T = 0.5$; therefore,

$$m = (1.5 - 0.5) / (1.5 + 0.5) * 100\% = 50\%.$$

[Figure 5-5 on page 278](#) shows AM signals with modulation indexes varying from 0 to 100%.

When the baseband signal is symmetrical, the modulation index can also be expressed in terms of the average carrier level, A , and the envelope peak, r , relative to the carrier. Then $P = A + r$, and $T = A - r$, and the expression for modulation index becomes

$$m = (A + r - A + r) / (A + r + A - r) * 100\% = r / A * 100\%.$$

This is the expression which the Measuring Receiver evaluates when making an AM measurement. Referring back to [Figure 5-4 on page 277](#), it is apparent that $A = 1$ and $r = 0.5$ so

$$m = 0.5 / 1 * 100\% = 50\%$$

as before.

Figure 5-5 AM for Various Depths

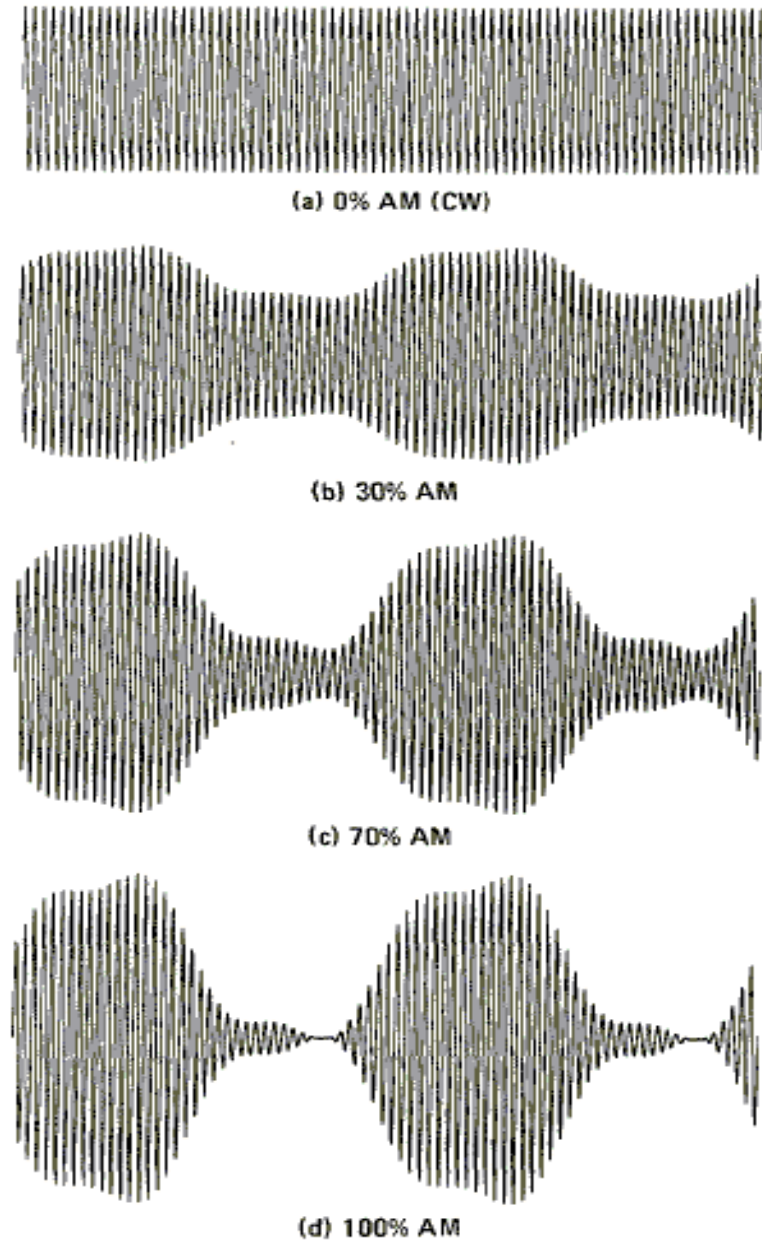
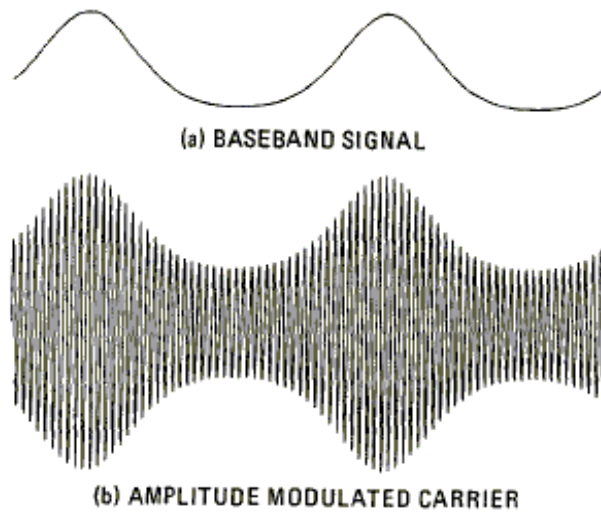

Figure 5-6 on page 279 illustrates an AM signal with an asymmetrical baseband source. The first definition of modulation index still applies here. For it, $m = 46\%$. The second definition, however, does not apply since $P - A$ is not equal to $A - T$. The Measuring Receiver detects a different value for r if the positive peak of the recovered signal is detected than if the negative peak is detected. Thus a different modulation index is measured for PEAK+ than for PEAK-.

Figure 5-6 AM with an Asymmetrical Baseband Signal



The range of modulation indexes for AM measurements by the Measuring Receiver is essentially 0 to 100%. There are, however, types of modulation that produce modulation indexes greater than 100%. An example of such is suppressed-carrier AM. The Measuring Receiver is not intended for measuring such signals. Nevertheless, there are cases, when the Measuring Receiver will display a modulation index that exceeds 100%. This can occur, for example, on an asymmetrical waveform where a narrow peak is greater than the average carrier level. This is illustrated in [Figure 5-7 on page 279](#).

Figure 5-7 AM with Modulation Exceeding 100% as Measured by the Peak+ Detector

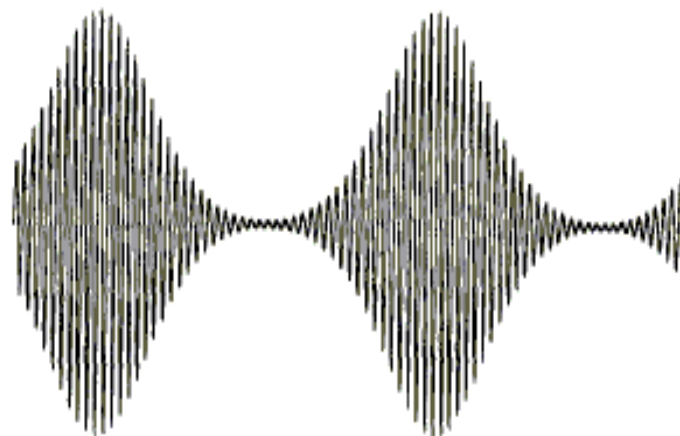

Phase (Exponential) Modulation

Phase (Exponential, or angular) modulation is the generic name given to modulation in which the frequency or phase of the carrier is varied. Frequency and phase modulation are very closely related. In fact, it is impossible to tell whether the signal was produced by a frequency modulator or phase modulator by analyzing the received signal unless specific information about the baseband signal is given.

It is certainly true to say that a signal is frequency modulated when the modulation is generated by a frequency modulator. A varactor diode across the tank circuit of an LC oscillator will produce FM when the varactor bias is varied. (It is assumed that the carrier is on the slope of the filter and that the filter is driven from a well-buffered carrier source. This modulator simultaneously produces AM.)

The signal from both modulators will show readings on the Measuring Receiver when in both the FM and Φ M measurement modes. When in FM, the quantity being measured is the peak frequency deviation, which is the maximum frequency excursion from the average carrier frequency. When measuring Φ M, the peak phase deviation is measured, which is the maximum phase excursion from the average carrier phase. Phase and frequency have the relationship that phase is the integral of the frequency or frequency is the derivative of the phase.

This relationship is most easily visualized by some examples. Look at [Figure 5-8 on page 282](#). The first baseband signal shown is a square wave. The three waveforms under it are the result of applying this signal to an FM, Φ M, and AM modulator respectively. (The AM waveform is included only for reference.) It is assumed that the phase modulator doesn't produce AM - only Φ M. The FM waveform is as expected. The frequency goes up on the positive peak of the baseband signal and down on the negative peak. The phase modulated signal, however, is peculiar. The frequency is generally constant throughout except for a discontinuity where the baseband signal switches amplitude. The waveform of the figure was contrived so that a 180° phase shift occurred exactly at a zero crossing of the carrier. Mathematically, the derivative of a square wave is the constant zero, except for a positive spike (impulse) where the baseband signal switches positive and a negative spike where the square wave switches negative.

Now look at the triangle wave [Figure 5-8 on page 282](#). The frequency modulator produces a continually increasing frequency as the baseband signal slopes upward and a continually decreasing frequency as the signal slopes downward. The phase modulator produces a signal that resembles the signal from the frequency modulator for the square wave baseband signal. This is because the derivative of a constant slope is a constant. When the slope is positive, the phase shift is continually increasing, thus producing a uniform frequency shift upward. When the slope is negative, the phase shift is continually decreasing and produces

a downward frequency shift. For the triangle wave baseband signal, the shift in frequency when the slope changes is proportional to the change in slope.

Figure 5-8 Signals from Frequency, Phase and Amplitude Modulators for Various Baseband Signals (Square and Triangle Waves)

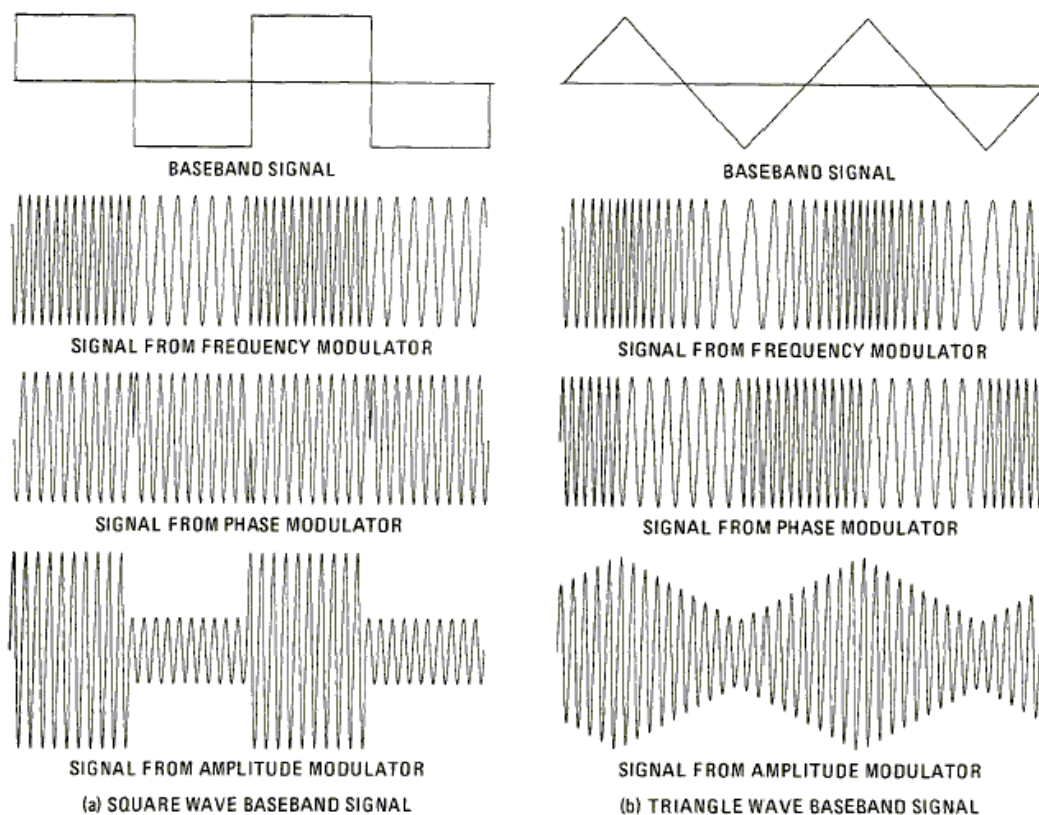

Now note the sine wave of [Figure 5-9 on page 283](#). The signals from the frequency and phase modulators look the same except for the 90 phase shift between two. For the frequency modulated signal, the frequency is highest when the baseband signal is most positive and lowest when most negative. For the phase modulated signal, the frequency is highest when the slope of the baseband signal is steepest in a positive direction. This occurs at the positive-going zero crossing. Similarly, the frequency is lowest when the slope is most negative.

If in the last example, the rate, but not the amplitude, of the baseband signal is increased, the highest and lowest frequencies of the signal from the frequency modulator stay the same- they just occur more often. However, for the signal from the phase modulator, not only do the frequency peaks occur more often, but the excursions are large because the slopes of the baseband signal are steeper at the zero crossings. See [Figure 5-9 on page 283](#).

Figure 5-9 Signals from Frequency, Phase and Amplitude Modulators for Various Baseband Signals (Sine Waves)

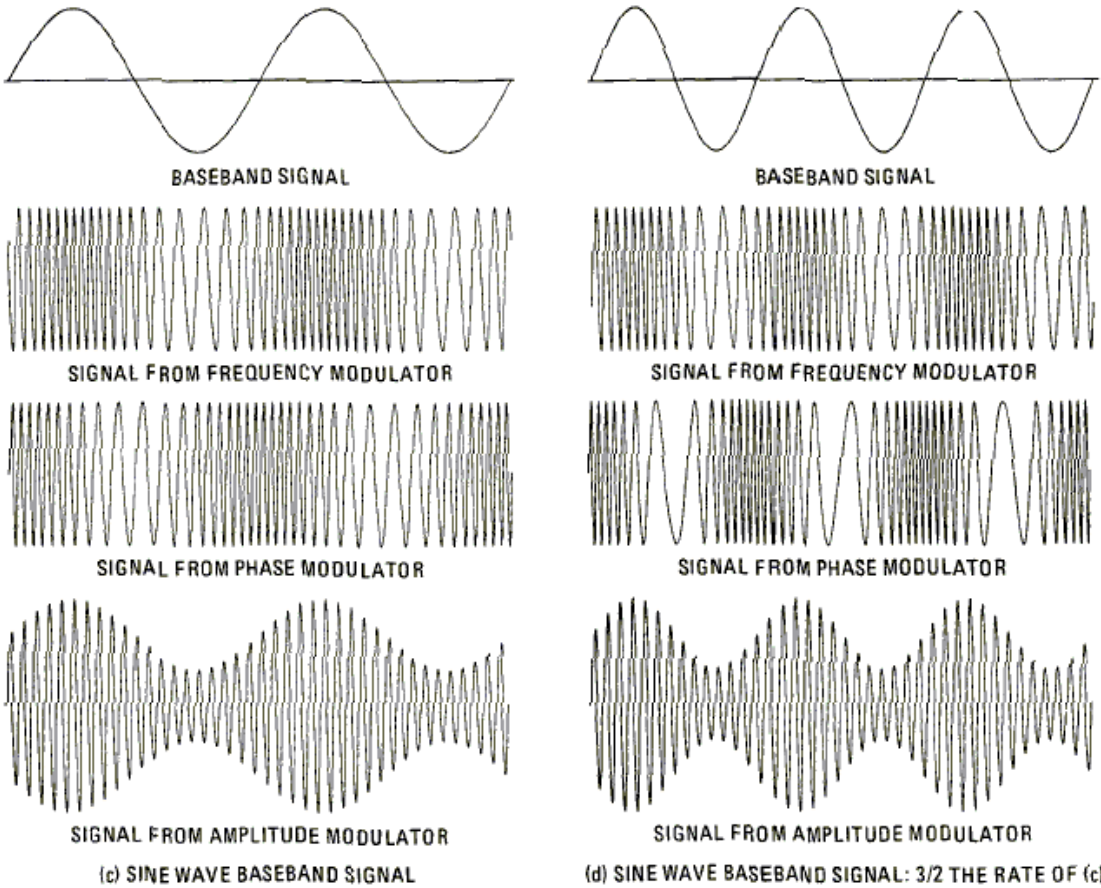

Other Considerations

In practice, it is difficult to produce an FM or Φ M signal which does not also have a small amount of AM- called incidental AM or AM-on-FM. Likewise, an AM signal usually contains a small amount of incidental FM and Φ M. In order to accurately measure this incidental modulation, the Measuring Receiver itself must not contribute to it. This contribution is specified as AM rejection and FM rejection.

A typical CW signal also contains a small amount of residual AM, FM, and Φ M. The residual modulation is generated by such things as line hum, noise, and microphonics. The residual AM and FM specifications quantify the residual modulation internal to the Measuring Receiver.

Residual modulation affects the modulation readings in a manner which depends on the detector used, the nature of the residuals, and the signal-to-noise ratio. If the residual is predominately noise, when the peak detector is used, the residuals add in a way that is statistically related to the signal-to-noise ratio. When the average detector is used, the residuals add approximately in an rms manner, that is, the square root of the sum of the squares of the noise and the signal. The effect of this noise becomes insignificant, however, when the signal-to-noise ratio is above a few dB. Noise can be further reduced by filtering the demodulated signal.

In FM broadcasting and communications, the signal-to-noise ratio is improved by giving the baseband signal a high-frequency boost before applying it to the modulator. This is called pre-emphasis. The boost is a simple 6 dB per octave with the 3 dB corner specified by a time constant; for example, 75 μ s (which corresponds to a 3 dB corner of 2.12 kHz) is used for commercial broadcast FM. If desired, the demodulated FM can be de-emphasized to equalize the signal at the modulation output and at the display.

AM Depth Measurement Concepts

Purpose

AM Depth measures the amount of AM on an RF carrier. Modulation depths to 99% can be measured.

Measurement Technique

Amplitude Modulation (AM) of a sine or cosine carrier results in a variation of the carrier amplitude that is proportional to the amplitude of the modulating signal that contains information. AM is a linear process. The modulating signal varies the amplitude of the resultant modulated signal, therefore, changing power of the carrier.

A quantity which describes the amount of the AM depth (usually expressed in %) is defined as:

Equation 5-2

$$\%_{AM} = \frac{V_P - V_T}{V_P + V_T} \times 100\%$$

where:

VP = the peak amplitude of the AC component, and

VT = the trough amplitude of the AC component. See [Figure 5-10 on page 285](#).

Figure 5-10 Amplitude Modulated Carrier

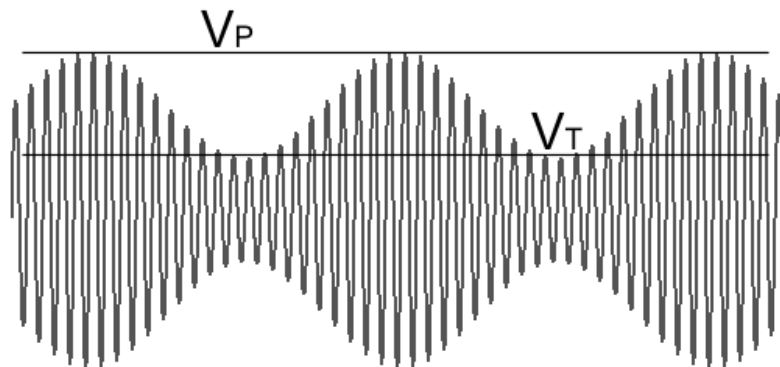

FM Deviation Measurement Concepts

Purpose

FM Deviation measures the frequency deviation of the tuned input signal. The demodulation signal's frequency and distortion can also be measured.

Measurement Technique

Frequency deviation is the maximum frequency excursion from the average carrier frequency. The FM on the IF is demodulated by a frequency discriminator. The amplitude of the discriminator's output is proportional to the frequency deviation. The demodulated signal is filtered, audio detected, and displayed as Hz deviation. FM de-emphasis equalization can be inserted ahead of the audio detectors, and the demodulated FM signal always passes through the FM de-emphasis "network".

PM Deviation Measurement Concepts

Purpose

PM Deviation measures the phase deviation of the tuned input signal.

Measurement Technique

Phase deviation is the maximum phase excursion from the average carrier phase. Phase and frequency have the relationship that phase is the integral of the frequency or frequency is the derivative of the phase. The PM on the IF is first demodulated by a frequency discriminator. The amplitude of the discriminator's output is proportional to the frequency deviation. The demodulated signal is filtered and passed through an integrator, which extracts the phase information. The integrator's output is detected and displayed as phase deviation in radians.

Modulation Rate Measurement Concepts

Purpose

Modulation Rate measures the modulation frequency of a modulated AM/FM/PM signal applied to the RF port.

Measurement Technique

The Modulation Rate implies the frequency of the modulating signal. The PSA down-converts the RF signal to base-band and then perform the specified AM, FM or PM demodulation. Modulation Rate (demodulated signal frequency) is calculated by a time domain counter. See [Figure 5-11 on page 287](#).

Figure 5-11 Demodulation Diagram

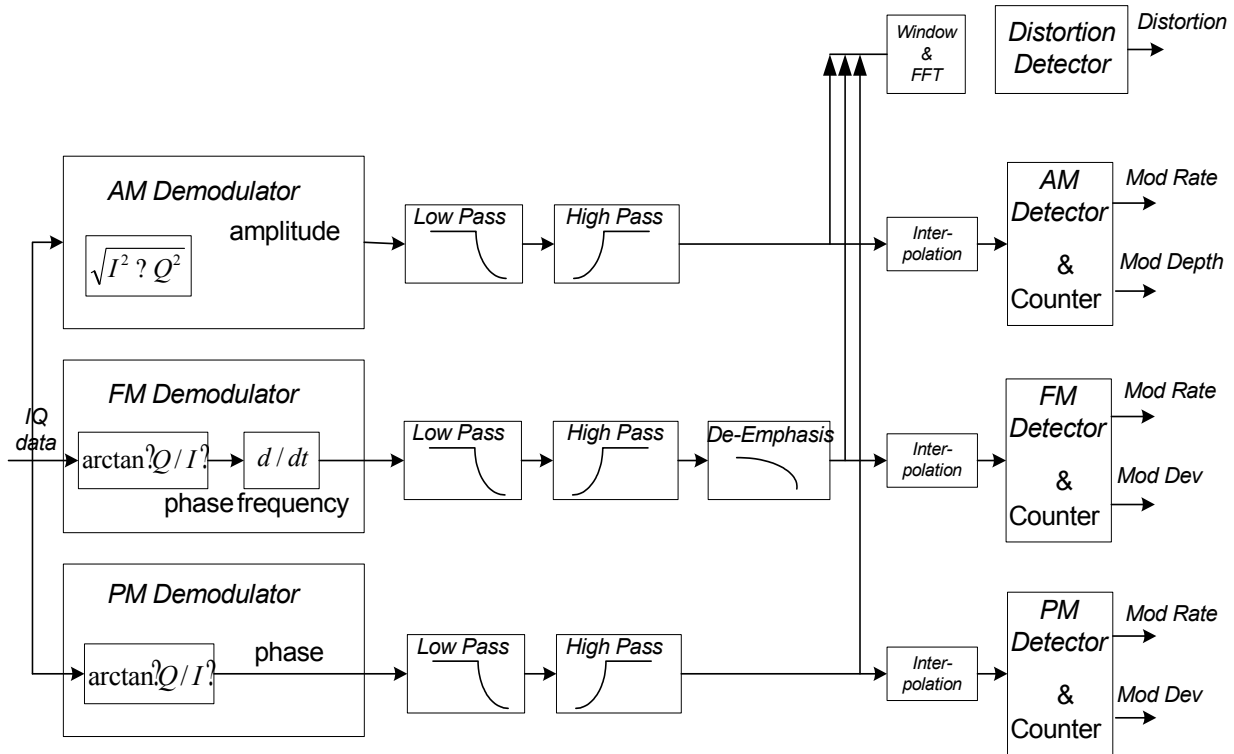

Modulation Distortion Measurement Concepts

Purpose

This measurement is used to measure the amount of modulation distortion contained in the Modulated signal by determining the ratio of harmonic and noise power to fundamental power. This measurement verifies the modulation quality of the signal from the UUT.

Measurement Technique

Modulation Distortion is defined as:

Equation 5-3

$$\%_{ModulationDistortion} = \sqrt{\frac{P_{total} - P_{signal}}{P_{total}}} \times 100\%$$

where: P_{total} = the power of the total signal,

P_{signal} = the power of the wanted modulating signal, and

$P_{total} - P_{signal}$ = total unwanted signal which includes harmonic distortion and noise.

See [Figure 5-11 on page 287](#). First, the received signal is demodulated and filtered to remove DC, then the filtered signal is transformed by an FFT into frequency domain. Next, total power in the total filter band is measured as P_{total} , the peak power of the modulated signal is computed as P_{signal} , the square root of the ratio of $P_{total} - P_{signal}$ to P_{total} is calculated. The result is signal's modulation distortion. It can be expressed as dB or %.

Modulation SINAD Measurement Concepts

Purpose

Modulation SINAD (Signal to Noise And Distortion) measures the amount of Modulation SINAD contained in the modulated signal by determining the ratio of fundamental power to harmonic and noise power. Modulation SINAD is reciprocal of modulation distortion provided by Modulation Distortion measurement. This is another way to quantify the quality of the modulation process

Measurement Technique

Modulation SINAD is defined as:

Equation 5-4

$$dB_{ModulationSINAD} = 20 \times \log \sqrt{\frac{P_{total}}{P_{total} - P_{signal}}}$$

where: P_{total} = the power of the total signal,

P_{signal} = the power of the wanted modulating signal, and

$P_{total} - P_{signal}$ = the total unwanted signals which include harmonic distortion and noise.

See [Figure 5-11 on page 287](#). First, the received signal is demodulated and filtered to remove DC, then the filtered signal is transformed by an FFT into frequency domain. Next, total power in the total filter band is measured as P_{total} , the peak power of the modulated signal is computed as P_{signal} , the square root of the ratio of P_{total} to $P_{total} - P_{signal}$ is calculated. The result is signal's Modulation SINAD. It can be expressed as dB or %.

Audio Measurement Concepts

Audio Frequency Measurement Concepts

Purpose

Audio Frequency measures the accurate Audio Frequency of an audio signal applied to the Audio port.

Measurement Technique

The audio frequency is calculated by a time domain counter. See [Figure 5-12 on page 290](#) for a graphical explanation of the process.

Figure 5-12 Audio Diagram

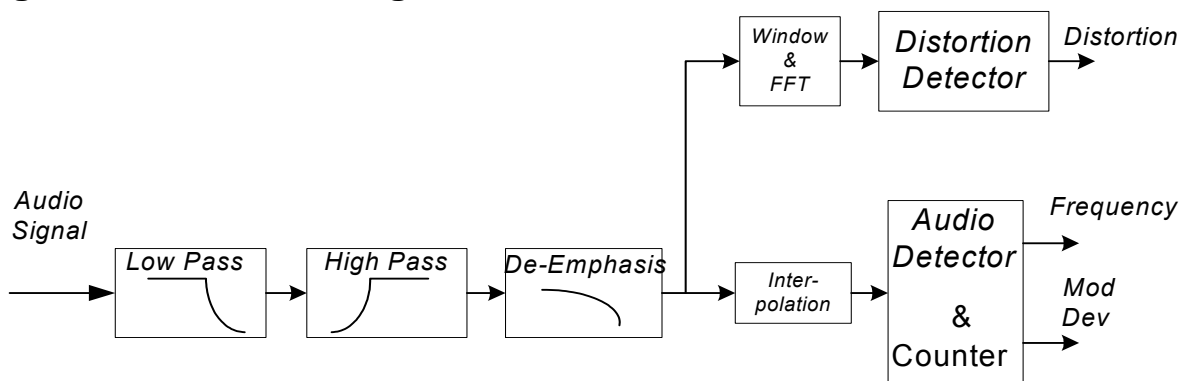

Audio AC Level Measurement Concepts

Purpose

Audio AC Level measures the true RMS level of an external signal.

Measurement Technique

The audio AC level is the average power of an external input audio signal. The true RMS level of audio signal can be measured using the RMS detector. Audio AC Level will not measure the DC level of an audio signal.

Audio Distortion Measurement Concepts

Purpose

Audio Distortion measures the amount of Audio distortion contained in the Audio signal by determining the ratio of harmonic and noise power to fundamental power.

Measurement Technique

Audio Distortion is defined as:

Equation 5-5

$$\%_{AudioDistortion} = \sqrt{\frac{P_{total} - P_{signal}}{P_{total}}} \times 100\%$$

where: P_{total} = the power of the total signal,

P_{signal} = the power of the wanted audio signal, and

$P_{total} - P_{signal}$ = total unwanted signal which includes harmonic distortion and noise.

See [Figure 5-12 on page 290](#). First, the received Audio signal is filtered to remove DC, then the filtered audio signal is transformed by an FFT into frequency domain. Next, total power in the total filter band is measured as P_{total} , the peak power of wanted signal is computed as P_{signal} , the square root of the ratio of $P_{total} - P_{signal}$ to P_{total} is calculated. The result is signal's Audio Distortion. It can be expressed as dB or %.

Audio SINAD Measurement Concepts

Purpose

Audio SINAD measures the amount of Audio SINAD contained in an Audio signal by determining the ratio of fundamental power to harmonic and noise power. Audio SINAD is the reciprocal of value provided for audio distortion by the Audio Distortion measurement.

The SINAD measurement is identical to the Audio distortion measurement; but the result is expressed differently. SINAD is often measured as part of receiver sensitivity testing.

SINAD can also be measured on an external audio signal applied to the AUDIO INPUT.

Measurement Technique

Audio SINAD is defined as:

Equation 5-6

$$dB_{AudioSINAD} = 20 \times \log \sqrt{\frac{P_{total}}{P_{total} - P_{signal}}}$$

where: P_{total} = the power of the total signal,

P_{signal} = the power of the wanted signal, and

$P_{total} - P_{signal}$ = the total unwanted signals which include harmonic distortion and noise.

To measure SINAD, the instrument compares the input signal level measurement made with a true RMS detector to the same measurement made with the fundamental component removed. SINAD is then calculated as the ratio of the unfiltered signal to the signal with its fundamental removed. See [Figure 5-12 on page 290](#).

The received Audio signal is filtered to remove DC, then the filtered audio signal is transformed by an FFT into frequency domain. Next, total power in the total filter band is measured as P_{total} , the peak power of modulated signal is computed as P_{signal} , the square root of the ratio of P_{total} against $P_{total} - P_{signal}$ is calculated. The result is signal's Audio SINAD. It can be expressed as dB or %.

Other Sources of Measurement Information

Additional measurement application information is available through your local Agilent Technologies sales and service office. The following application notes provide more detailed information.

- Application Note 1449: Fundamentals of RF Microwave Power Measurements
- Application Note: 150 Spectrum Analysis Basics
- Application Note 150-1: Amplitude and Frequency Modulation
- 8902A Measuring Receiver Operation and Calibration Manual

6 **Menu Maps**

These menu maps are in alphabetical order by the front panel key label or oval cross-reference label. You can locate detailed information about each key/function at the page number listed in the figure title for each menu.

NOTE These menu maps are only for PSA front panel control.

N5531S Measuring Receiver System Measurement Key Flow

The key flow diagrams, shown in a hierarchical manner on the following pages, will help grasp the overall functional relationships for the front-panel keys and the softkeys displayed at the extreme right side of the screen. The diagrams are:

- “Mode Selection Key flow” on page 324
- “Det/Demod Key Flow (1 of 2)” on page 313
- “Input/Output Key Flow” on page 322
- “Frequency/Channel Key Flow” on page 319
- “System Setup Key Flow (1 of 4)” on page 340
- “Trace/View Key Flow” on page 344
- “Measurement Selection Key Flow” on page 323
- “Frequency Counter Amplitude Selection Key Flow” on page 320
- “Frequency Counter Measurement Setup Key Flow” on page 321
- “RF Power Amplitude Selection Key Flow” on page 338
- “RF Power Measurement Setup Key Flow” on page 339
- “TRFL Amplitude Selection Key Flow” on page 345
- “TRFL Measurement Setup Key Flow” on page 346
- “AM Depth Amplitude Selection Key Flow” on page 309
- “AM Depth Span Selection Key Flow” on page 310
- “AM Depth Measurement Setup Key Flow” on page 311
- “AM Depth Trigger Source Key Flow” on page 312
- “FM Deviation Amplitude Selection Key Flow” on page 315
- “FM Deviation Span Selection Key Flow” on page 316
- “FM Deviation Measurement Setup Key Flow” on page 317
- “FM Deviation Trigger Source Key Flow” on page 318
- “PM Deviation Amplitude Selection Key Flow” on page 334
- “PM Deviation Span Selection Key Flow” on page 335
- “PM Deviation Measurement Setup Key Flow” on page 336
- “PM Deviation Trigger Source Key Flow” on page 337
- “Modulation Rate Amplitude Selection Key Flow (1 of 2)” on page 328

- “Modulation Rate Measurement Setup Key Flow” on page 330
- “Modulation Distortion Amplitude Selection Key Flow (1 of 2)” on page 325
- “Modulation Distortion Measurement Setup Key Flow” on page 327
- “Modulation SINAD Amplitude Selection Key Flow (1 of 2)” on page 331
- “Modulation SINAD Measurement Setup Key Flow” on page 333
- “Audio Frequency Amplitude Selection Key Flow” on page 305
- “Audio Frequency Measurement Setup Key Flow” on page 306
- “Audio AC Level Amplitude Selection Key Flow” on page 301
- “Audio AC Level Measurement Setup Key Flow” on page 302
- “Audio Distortion Amplitude Selection Key Flow” on page 303
- “Audio Distortion Measurement Setup Key Flow” on page 304
- “Audio SINAD Amplitude Selection Key Flow” on page 307
- “Audio SINAD Measurement Setup Key Flow” on page 308

Directions for Use

Refer to the following notes to utilize the key-flow diagrams:

- Start from the upper left corner of each measurement diagram. Go to the right, and go from the top to the bottom.
- When changing a key from auto (with underline) to manual, just press that key one time.
- When entering a numeric value for **frequency**, a value with units, use the numeric keypad and terminate the entry with the appropriate unit selection from the softkeys displayed.
- When entering a numeric value for a unitless value, like **Avg Number**, use the numeric keypad and terminate the entry with the **Enter** front-panel key.
- Instead of using the numeric keypad to enter a value, it may be easier to use the front-panel knob or **Up/Down** arrow keys.

Table 6-1 Menu Map Legend



Icon	Description
	This represents the analyzer front-panel key.
	An oval represents additional levels of menus.
	This box shows how the softkey default condition is displayed. Default parameters or values are underlined wherever possible.

Table 6-1 Menu Map Legend

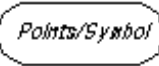

Icon	Description
	A dagger to the left of a softkey indicates that when the key is pressed this is an active function.
	A double-dagger to the left of the softkey indicates a function that is not always available. It is dependent on other instrument settings.
	A bar on the left of two or more softkeys indicates that the keys are a mutually exclusive choice.

Figure 6-1 Audio AC Level Amplitude Selection Key Flow

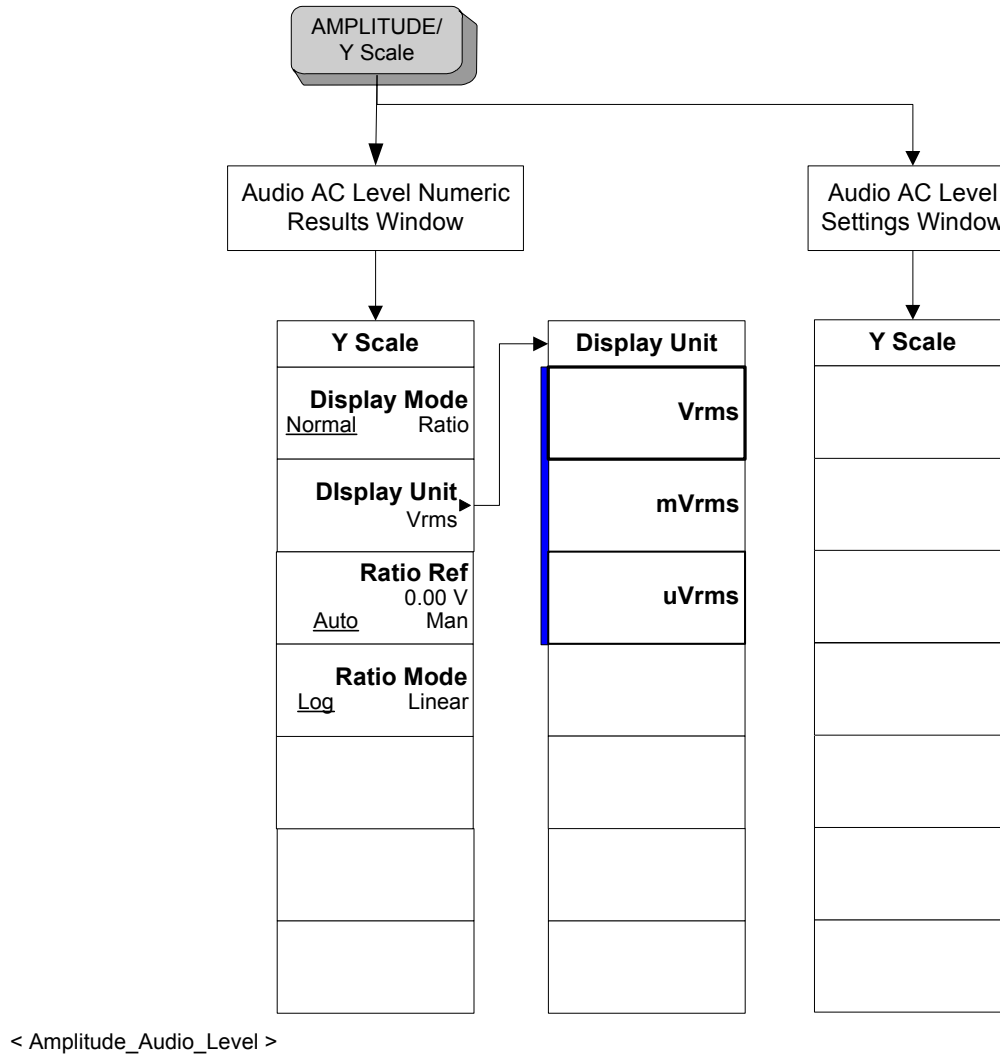
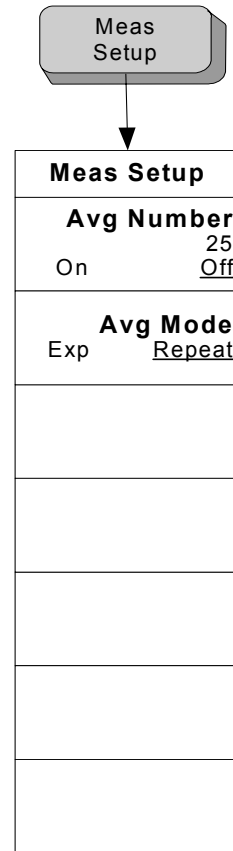

Figure 6-2 Audio AC Level Measurement Setup Key Flow



< Meas_Setup_Audio_Level >

Figure 6-3 Audio Distortion Amplitude Selection Key Flow

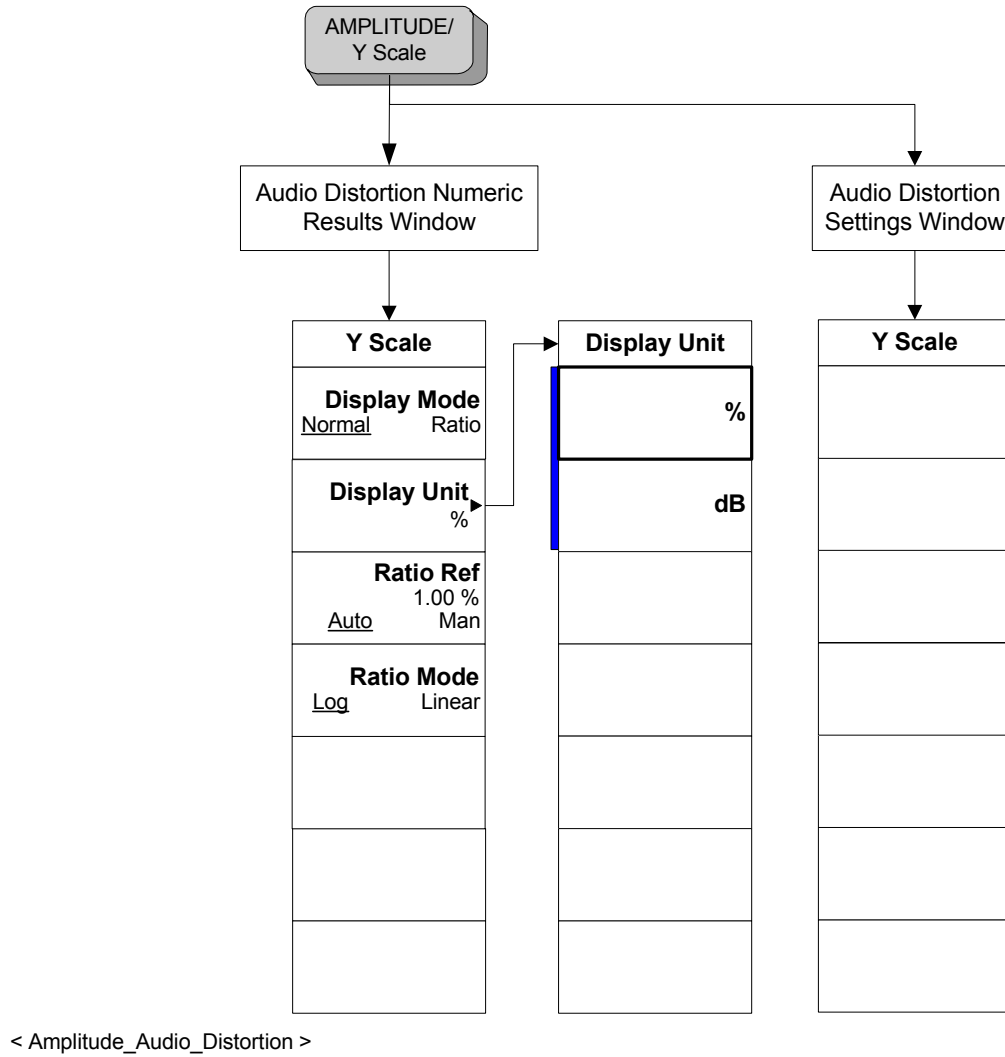
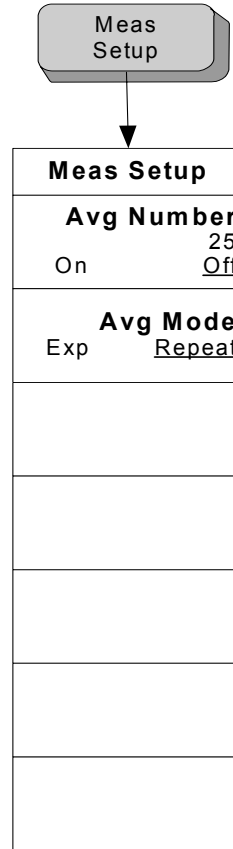

Figure 6-4 Audio Distortion Measurement Setup Key Flow



< Meas_Setup_Audio_Distortion >

Figure 6-5 Audio Frequency Amplitude Selection Key Flow

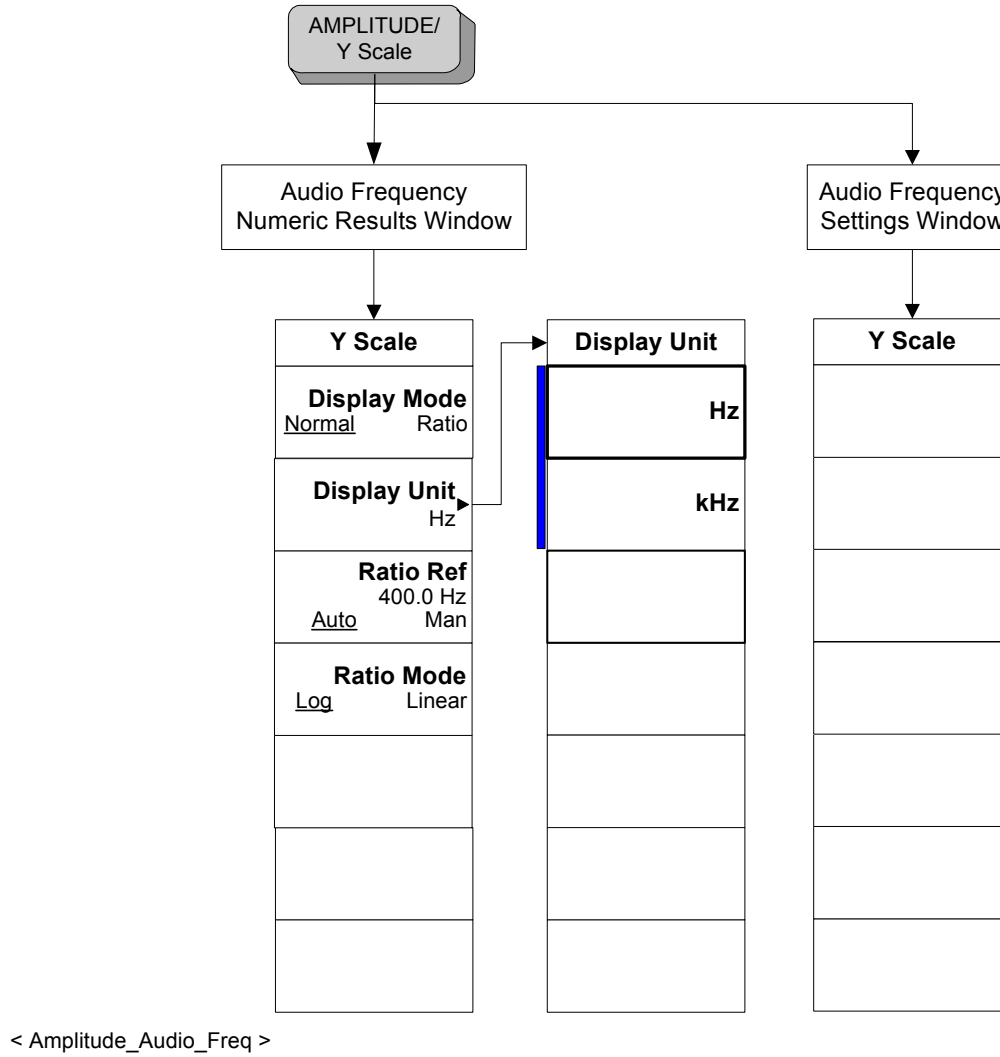
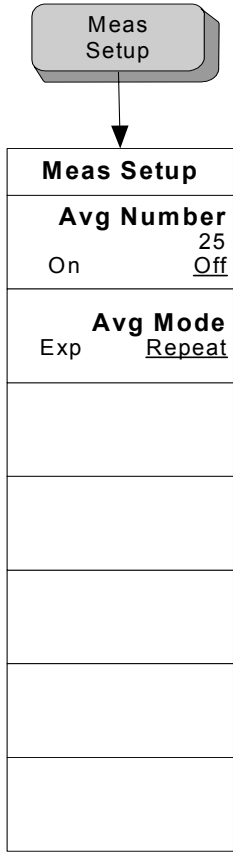

Figure 6-6 Audio Frequency Measurement Setup Key Flow



< Meas_Setup_Audio_Freq >

Figure 6-7 Audio SINAD Amplitude Selection Key Flow

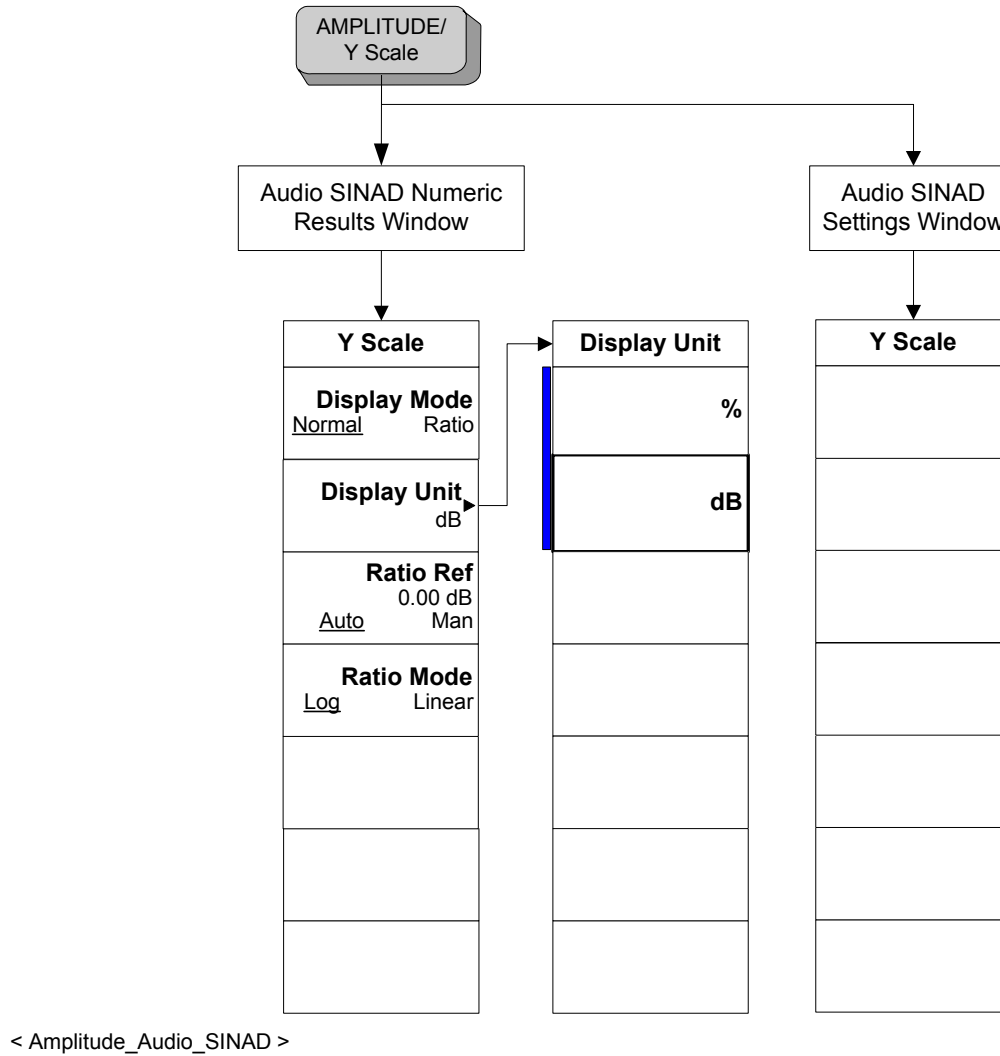
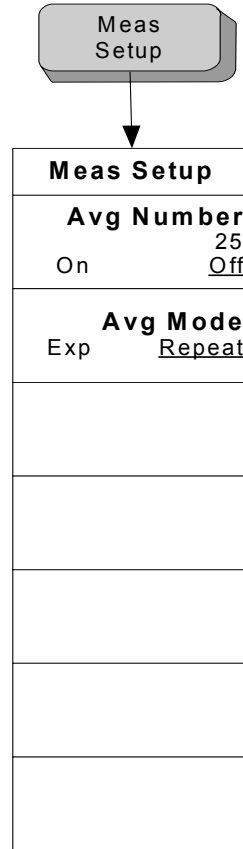

Figure 6-8 Audio SINAD Measurement Setup Key Flow



< Meas_Setup_Audio_SINAD >

Figure 6-9 AM Depth Amplitude Selection Key Flow

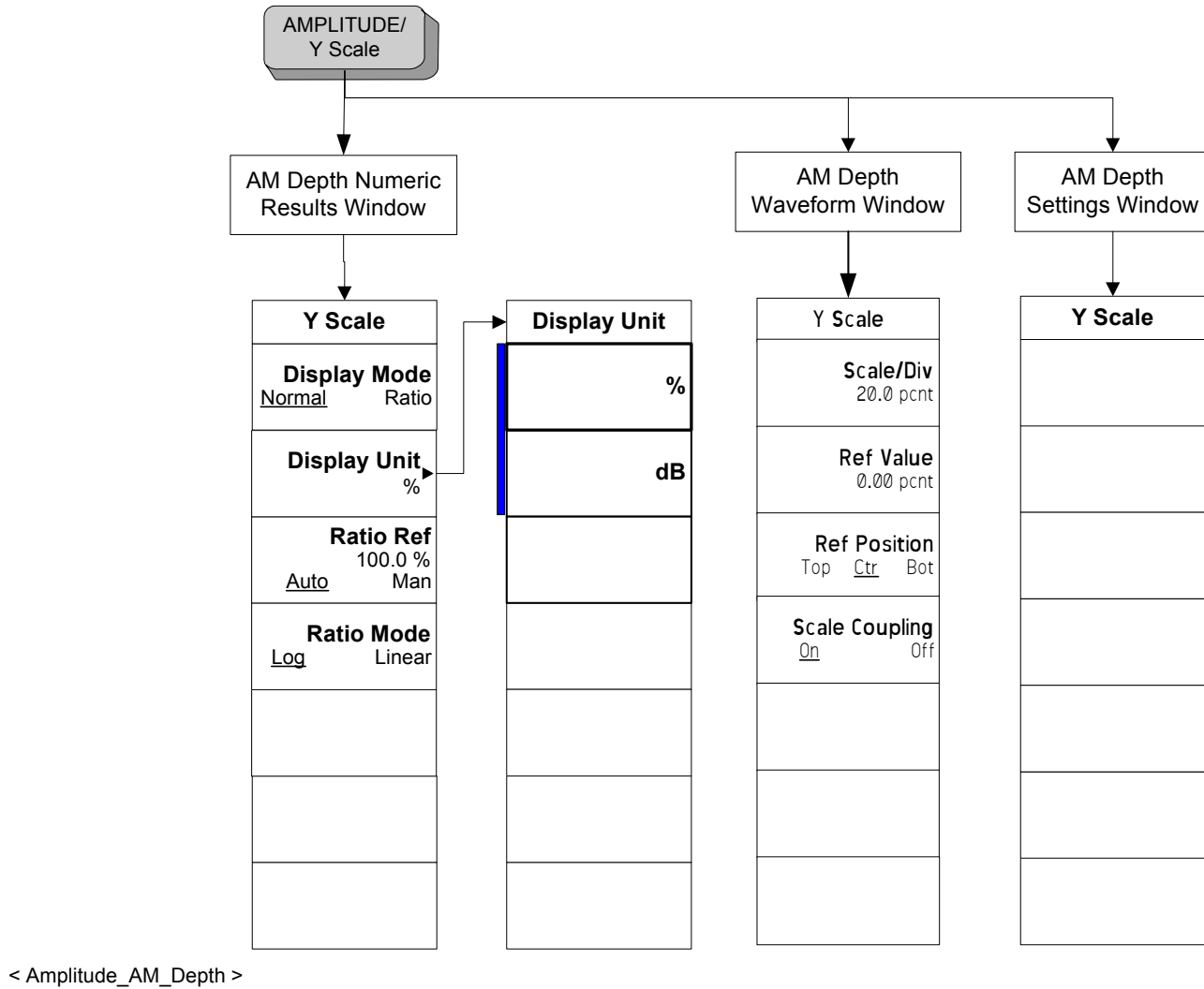
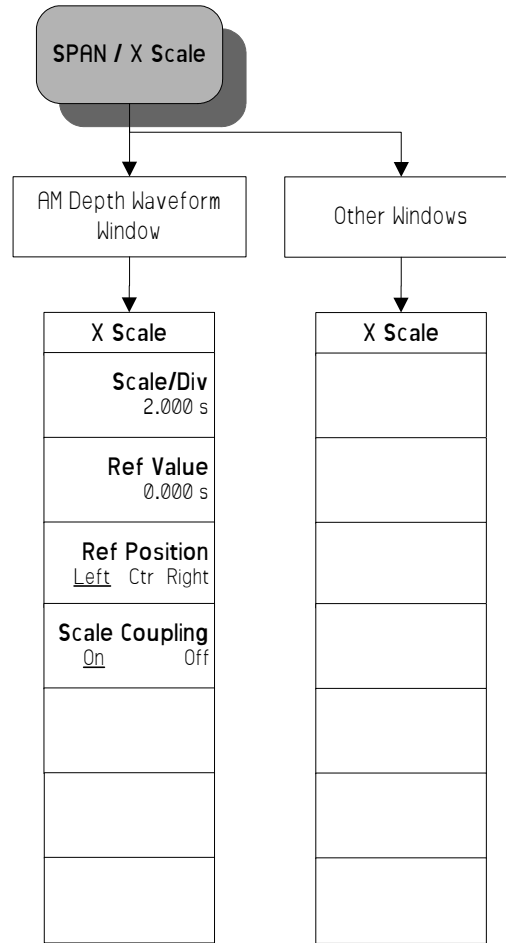
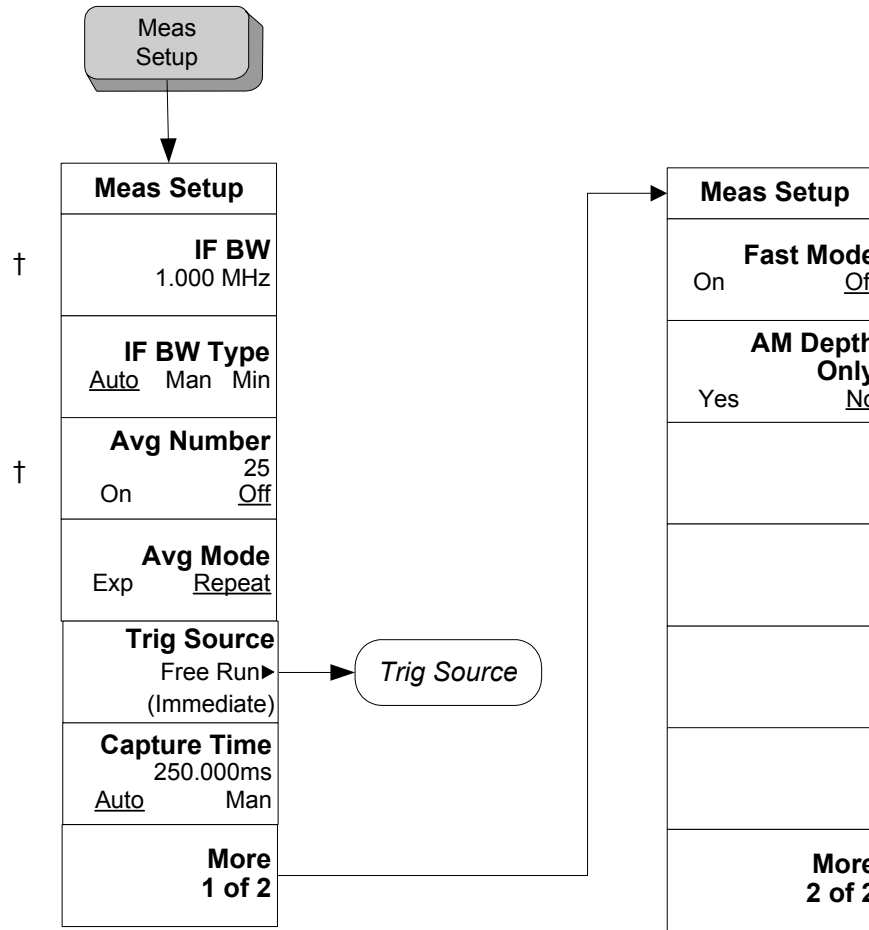

Figure 6-10 AM Depth Span Selection Key Flow



< Span_AM_Depth >

Figure 6-11 AM Depth Measurement Setup Key Flow



< Meas_Setup_AM_Depth >

Figure 6-12 **AM Depth Trigger Source Key Flow**



< Trig_Source >

Figure 6-13 Det/Demod Key Flow (1 of 2)

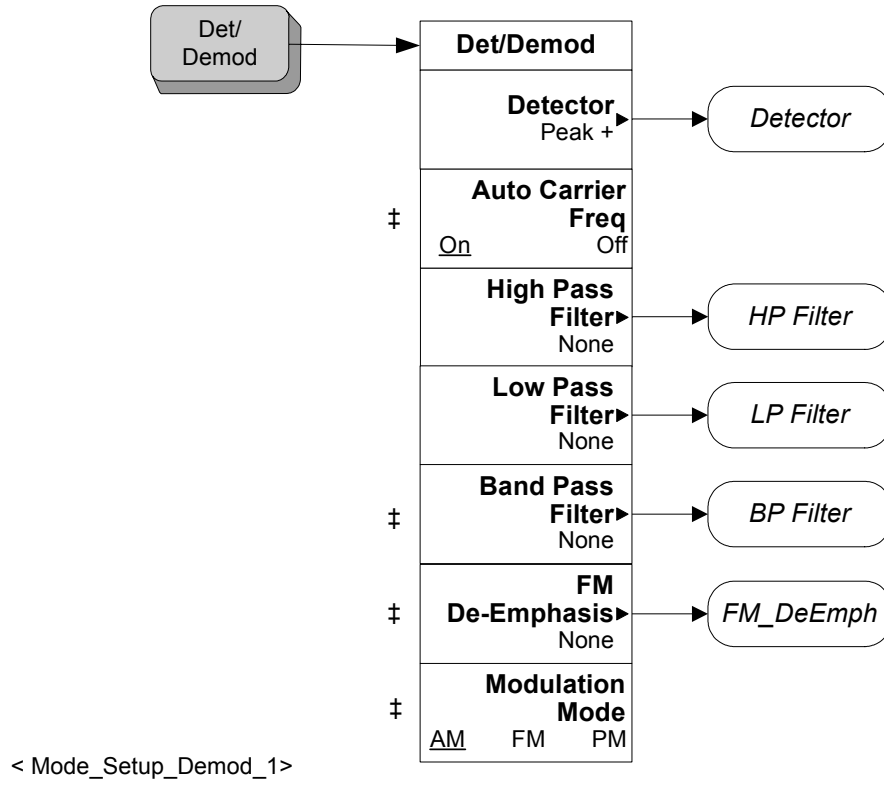
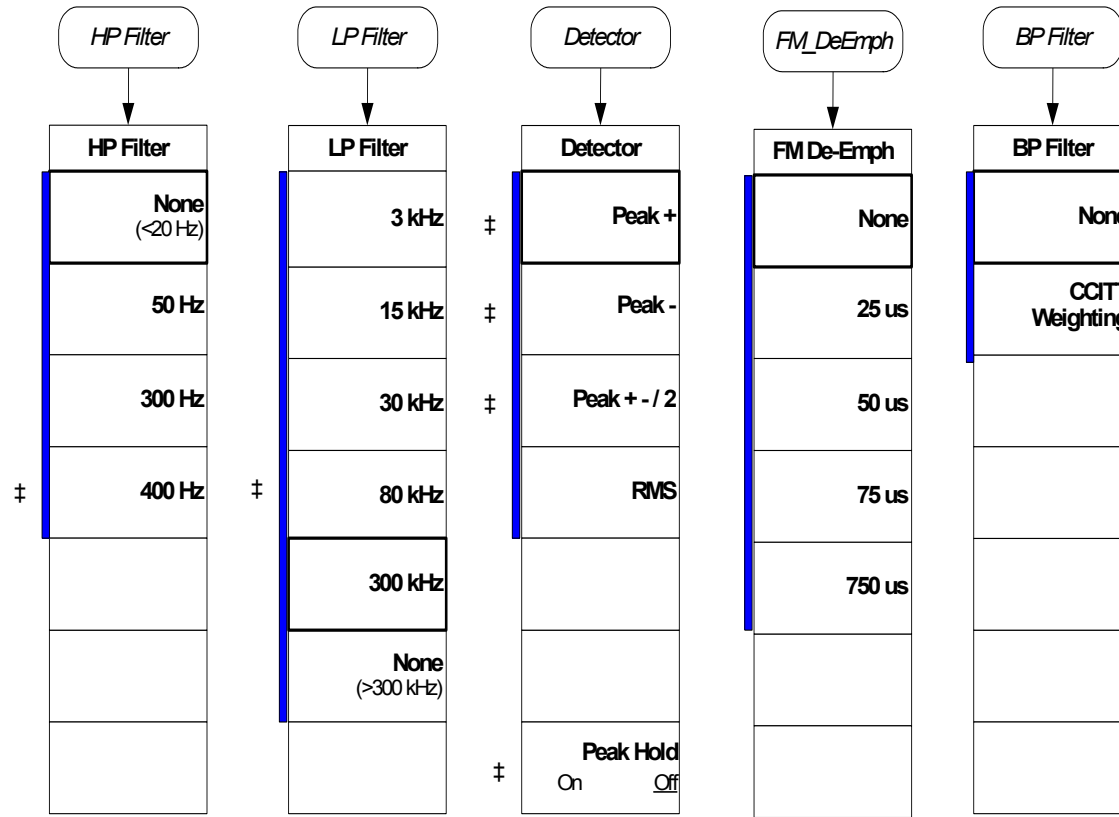

Figure 6-14 Det/Demod Key Flow (2 of 2)



<Mode_Setup_Demod_2>

Figure 6-15 FM Deviation Amplitude Selection Key Flow

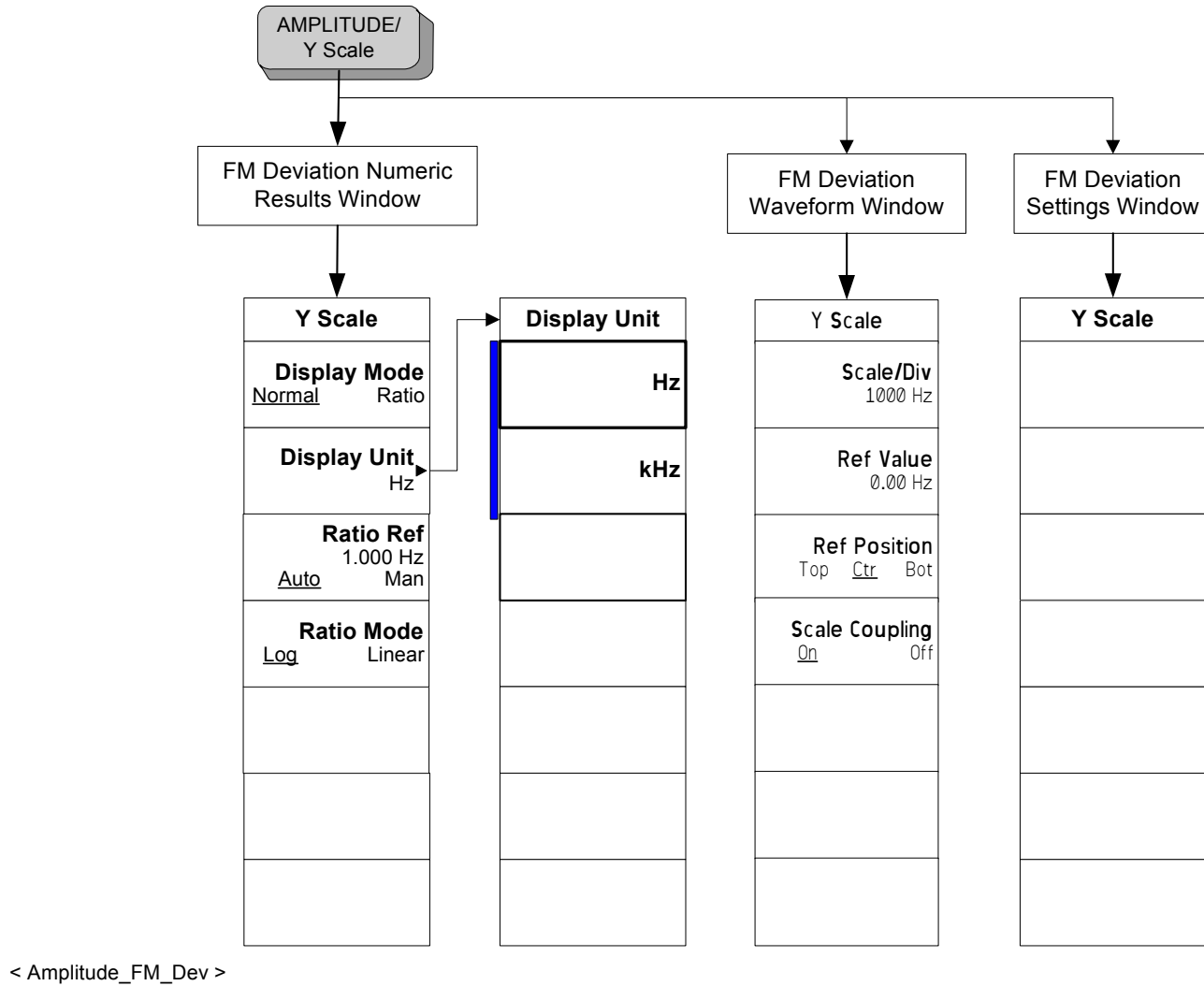
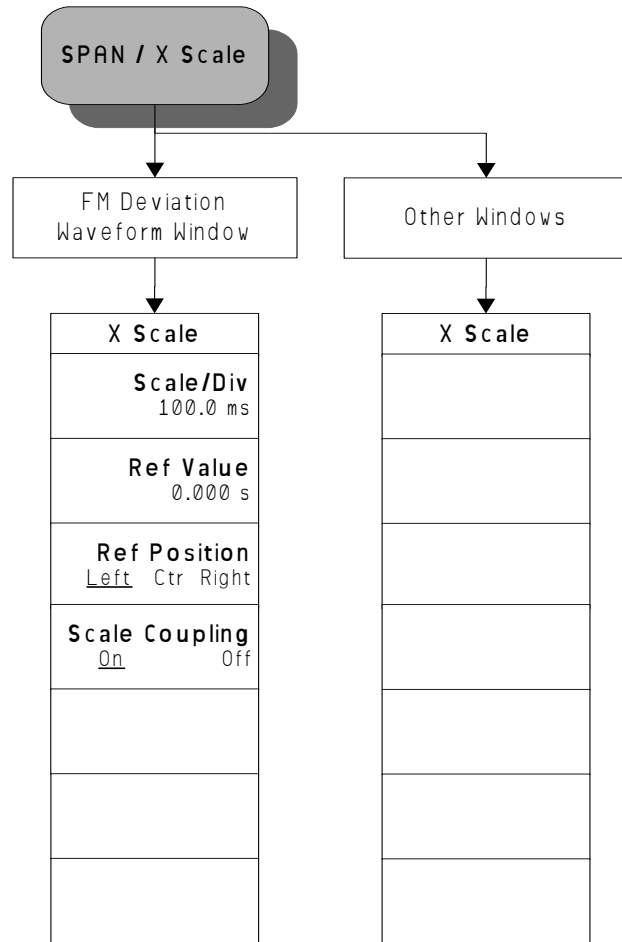

Figure 6-16 FM Deviation Span Selection Key Flow



< Span_FM_Deviation >

Figure 6-17 FM Deviation Measurement Setup Key Flow

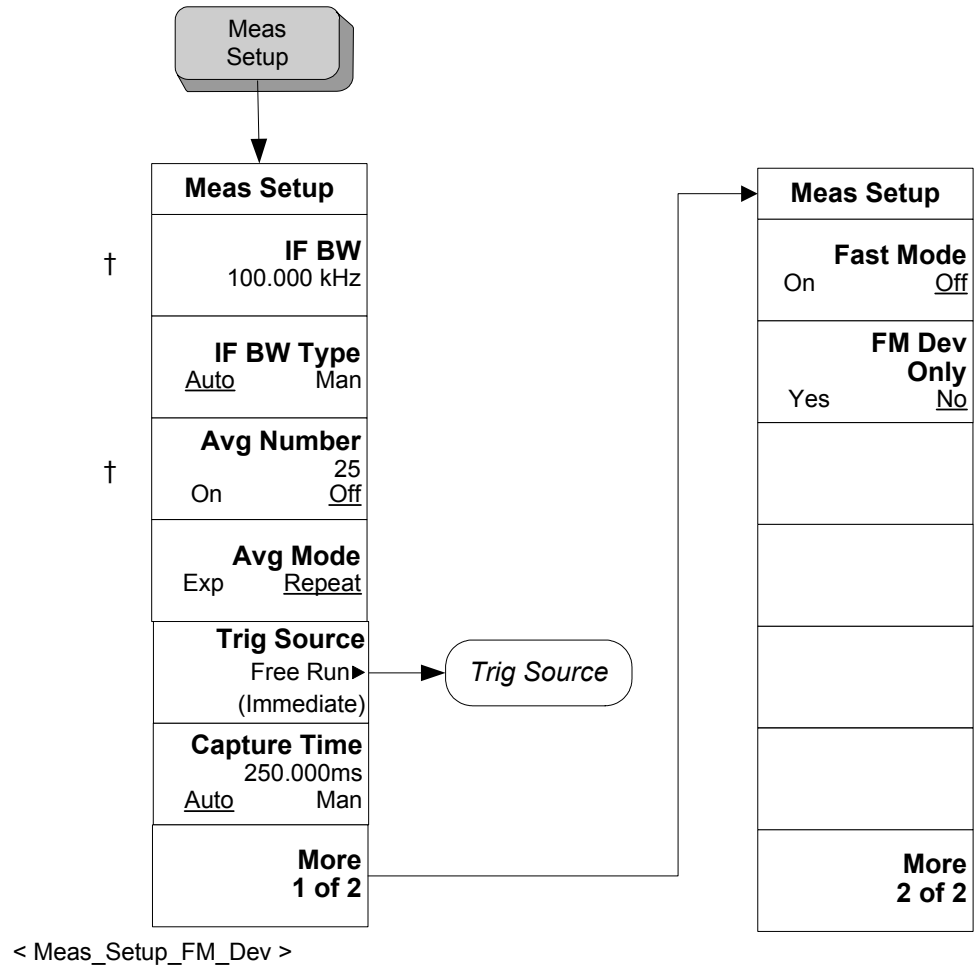

Figure 6-18 FM Deviation Trigger Source Key Flow



< Trig_Source >

Figure 6-19 Frequency/Channel Key Flow

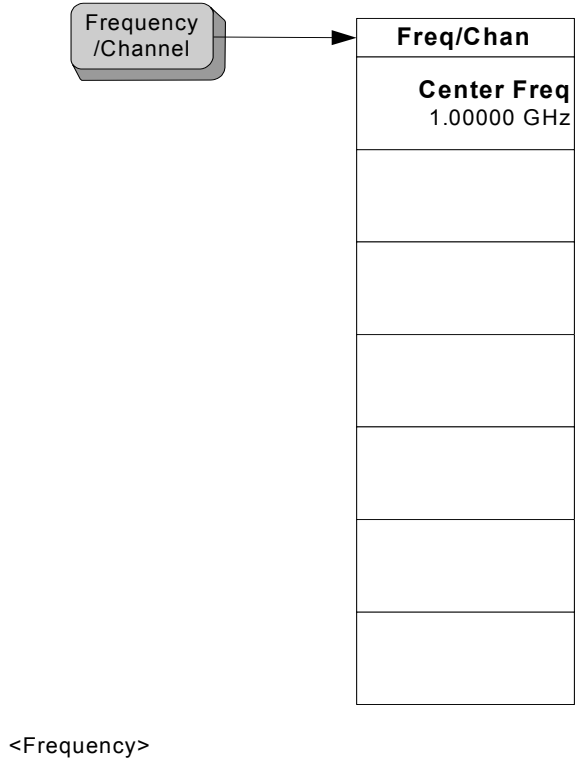
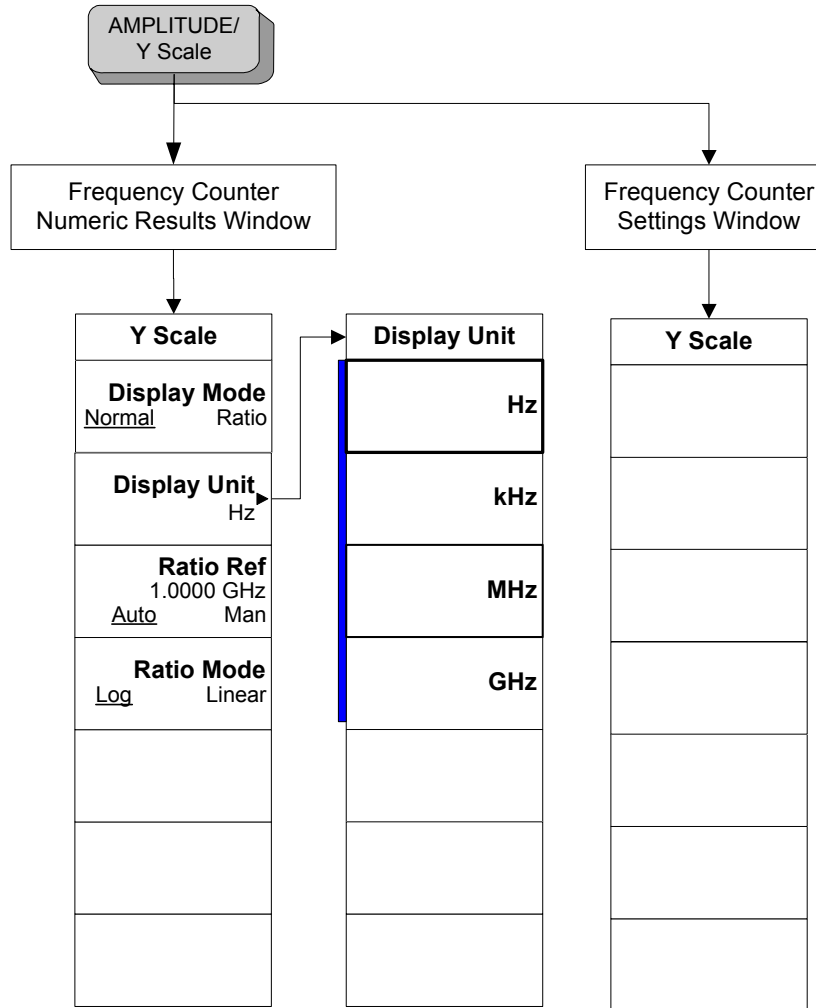
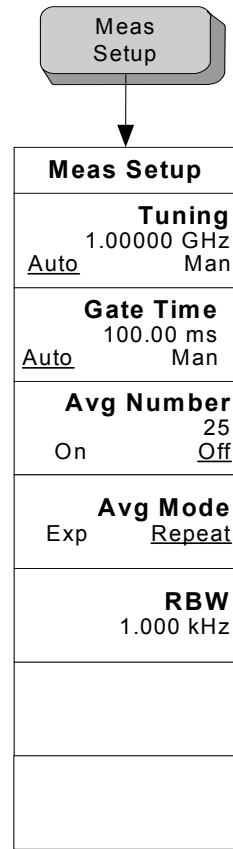

Figure 6-20 Frequency Counter Amplitude Selection Key Flow



< Amplitude_FreqCounter >

Figure 6-21 Frequency Counter Measurement Setup Key Flow



< Meas_Setup_FreqCounter >

Figure 6-22 Input/Output Key Flow

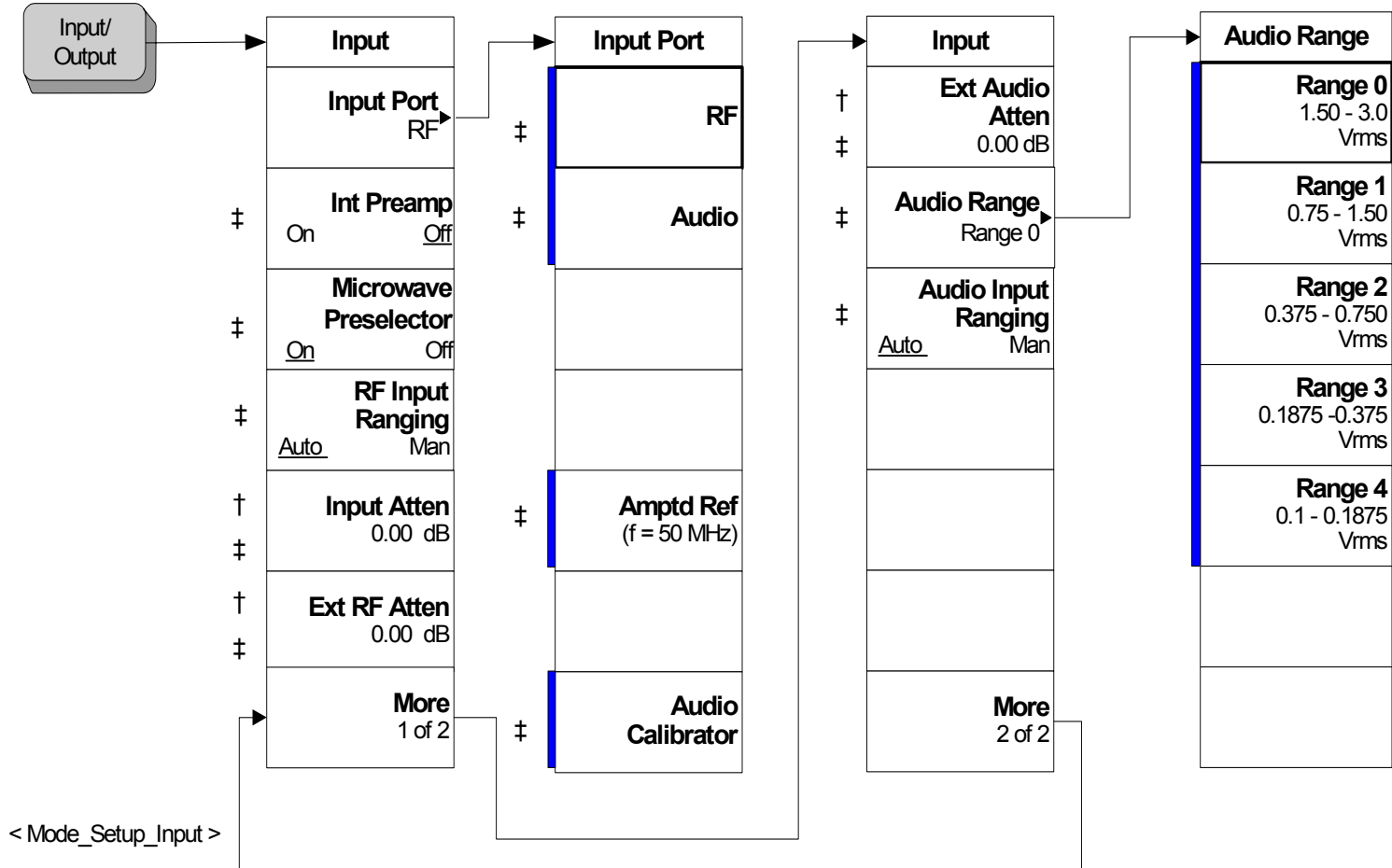

Figure 6-23 Measurement Selection Key Flow

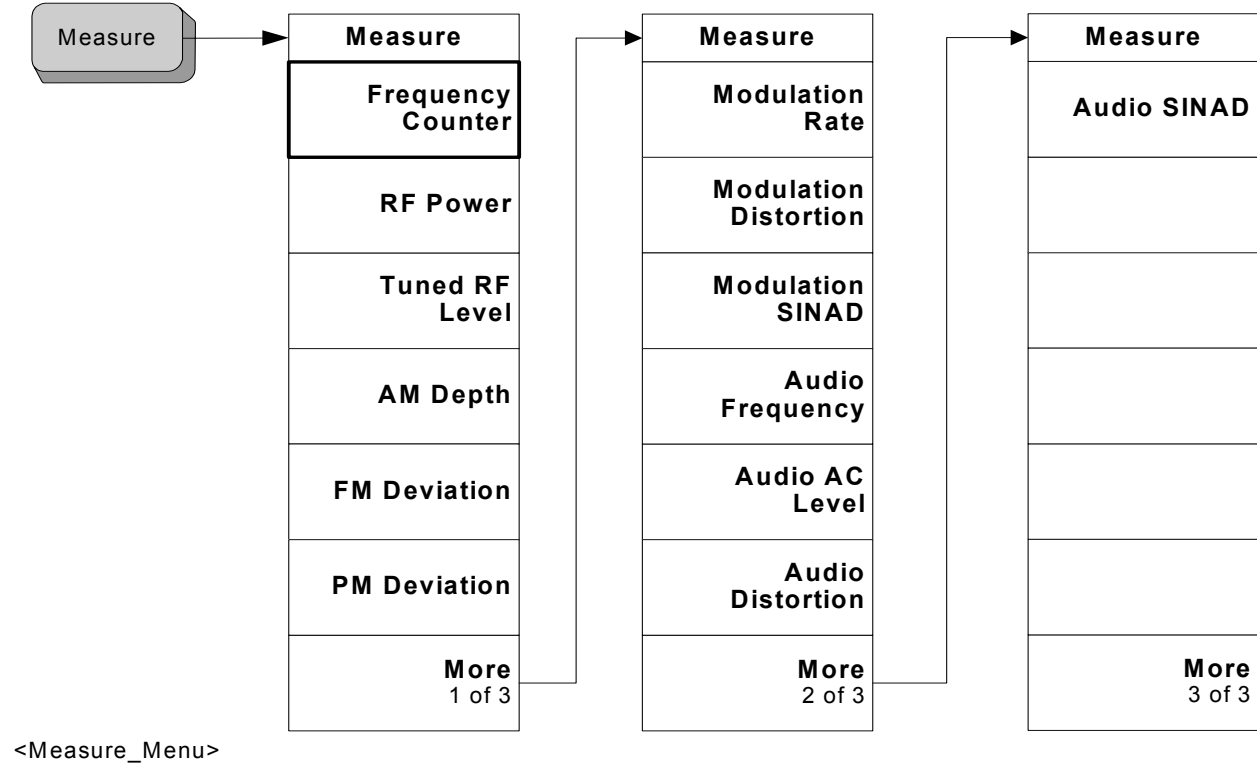

Figure 6-24 Mode Selection Key flow

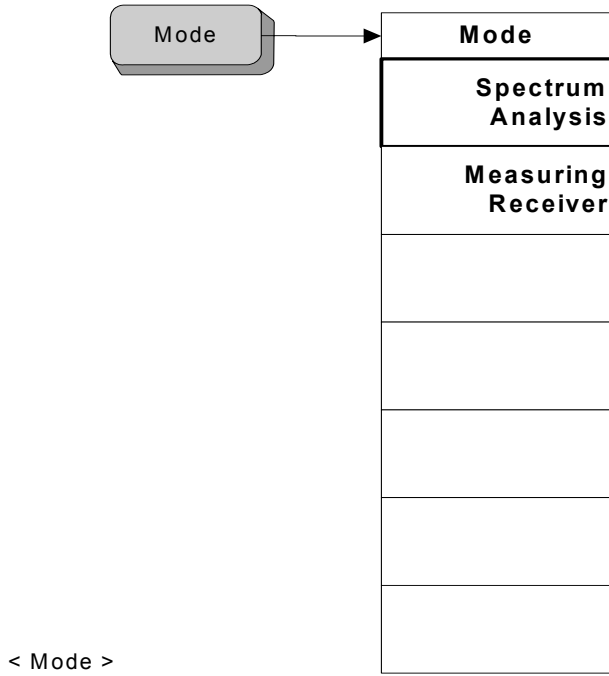

Figure 6-25 Modulation Distortion Amplitude Selection Key Flow (1 of 2)

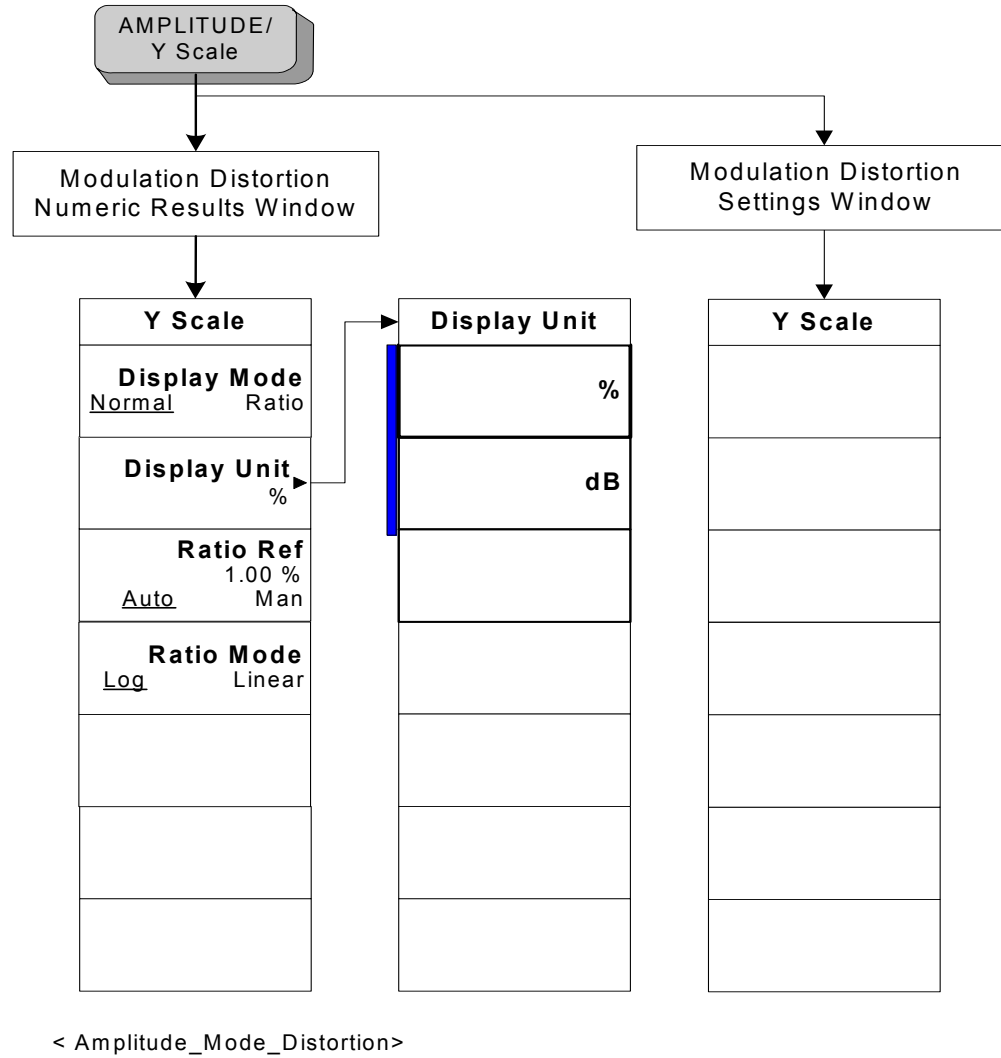
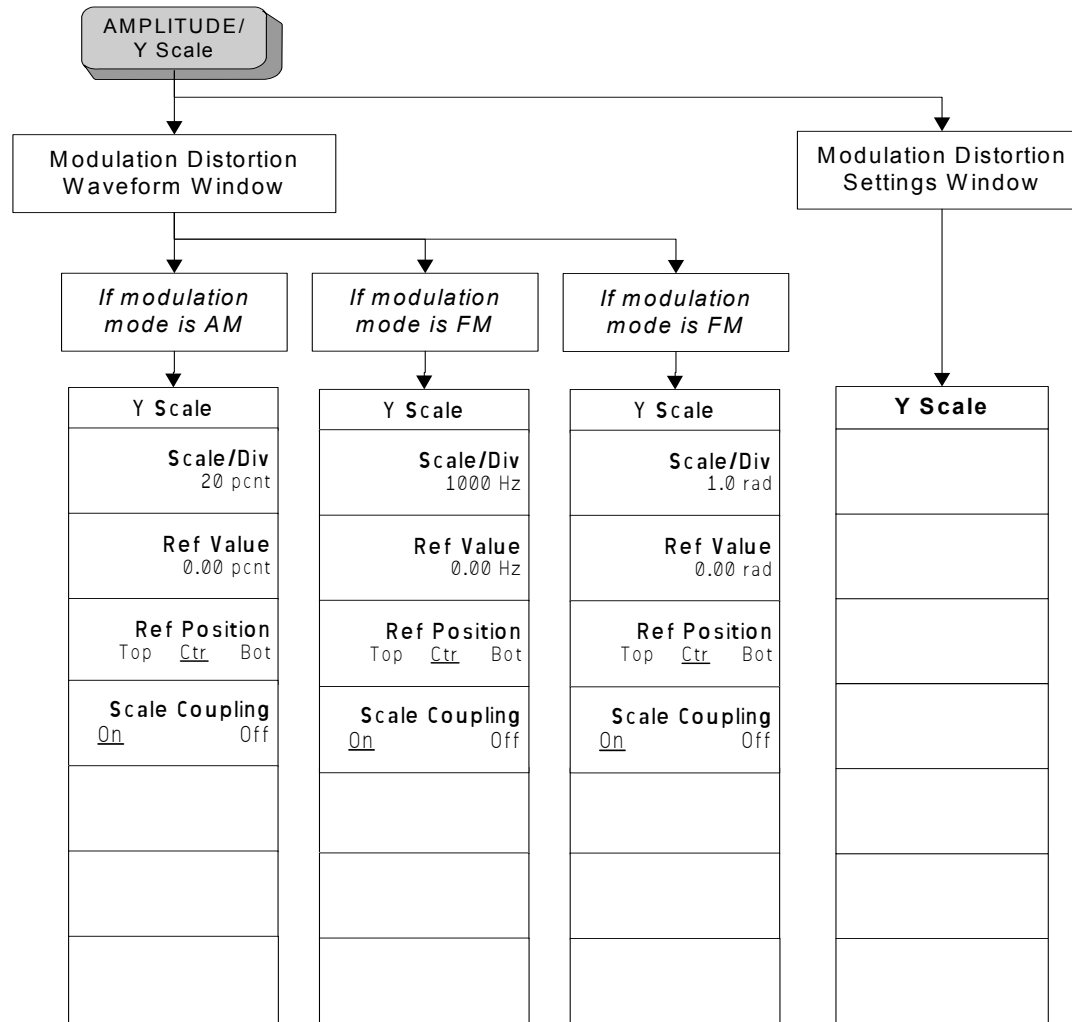
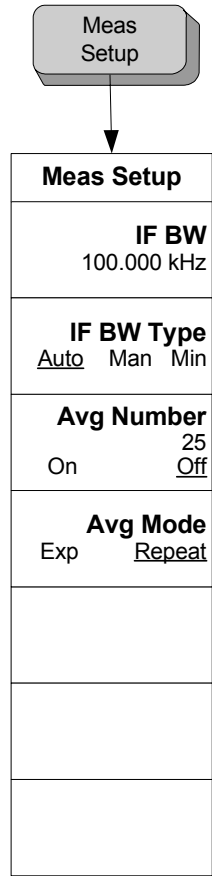

Figure 6-26 Modulation Distortion Amplitude Selection Key Flow (2 of 2)



< Amplitude_Mod_Distortion_2 >

Figure 6-27 Modulation Distortion Measurement Setup Key Flow



< Meas_Setup_Mod_Distortion >

Figure 6-28 Modulation Rate Amplitude Selection Key Flow (1 of 2)

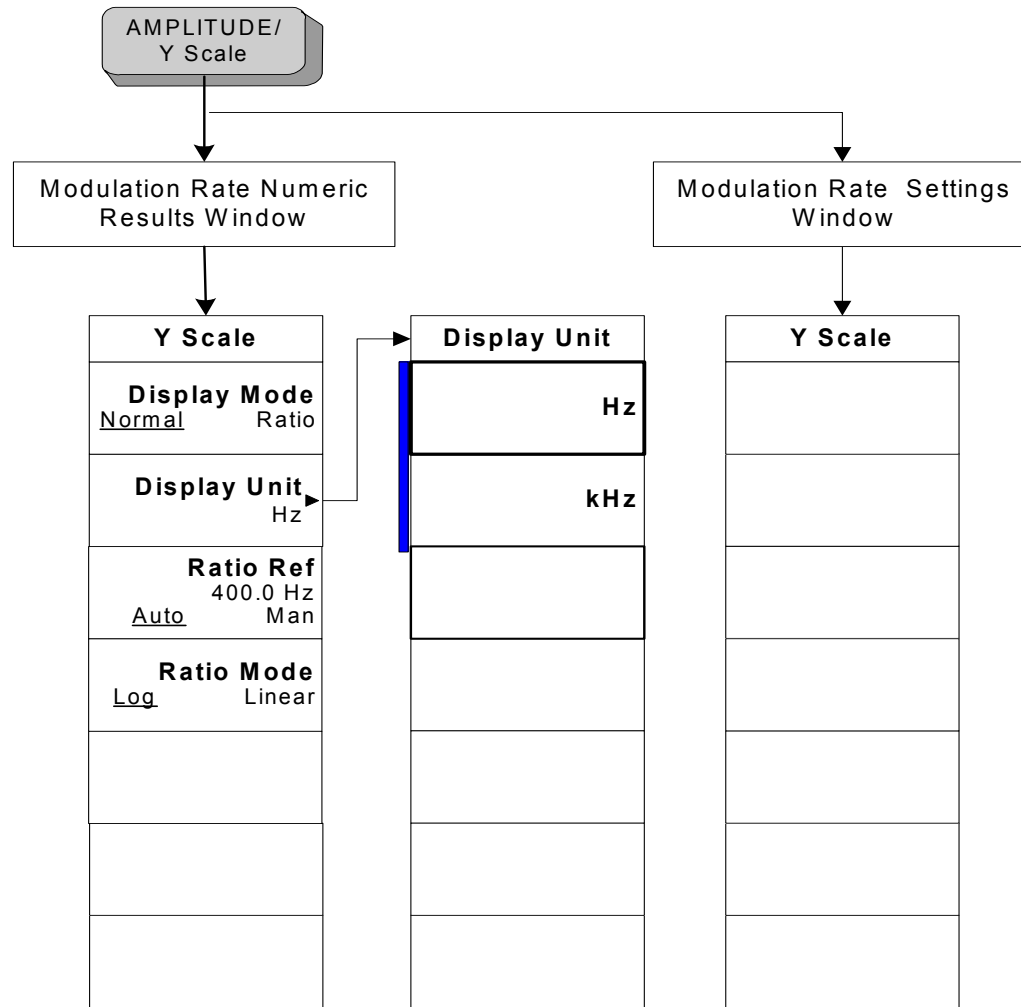

< Amplitude_Modu_Rate >

Figure 6-29 Modulation Rate Amplitude Selection Key Flow (2 of 2)

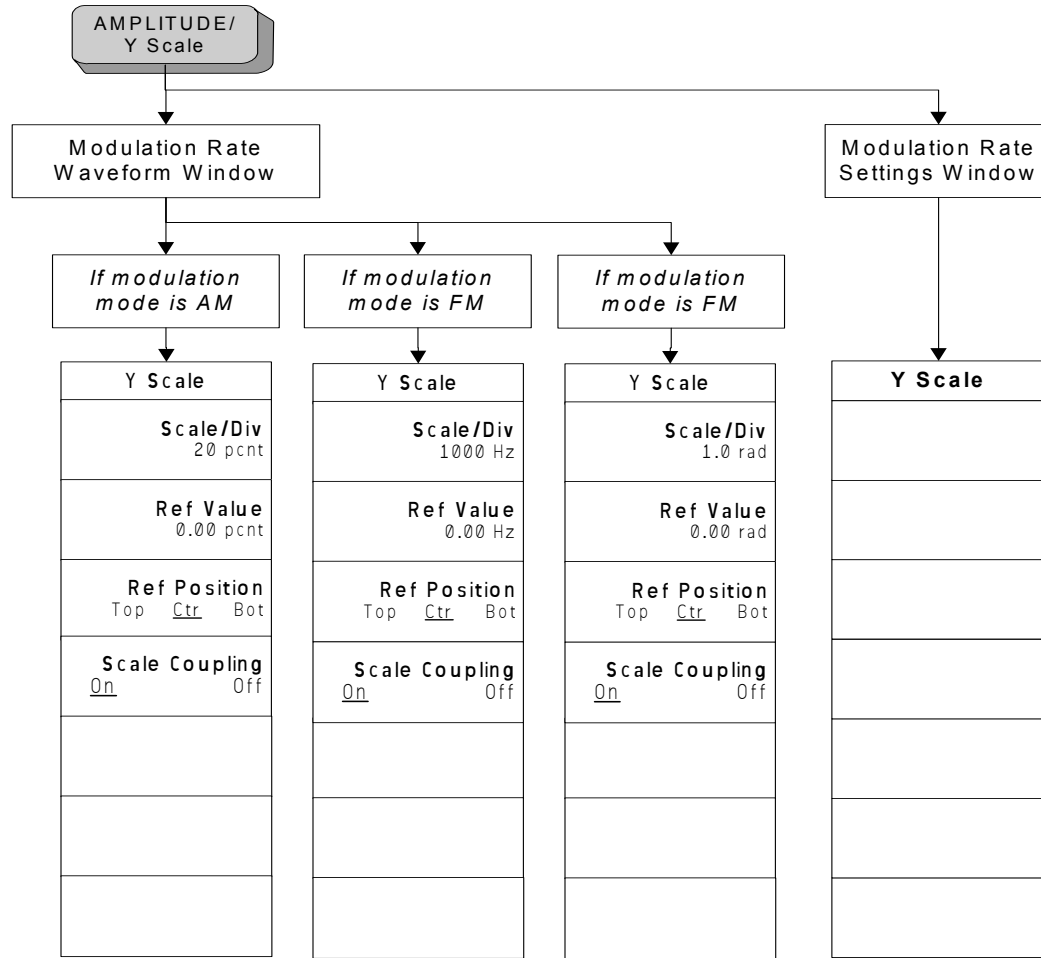

< Amplitude_Mod_Rate_2 >

Figure 6-30 Modulation Rate Measurement Setup Key Flow

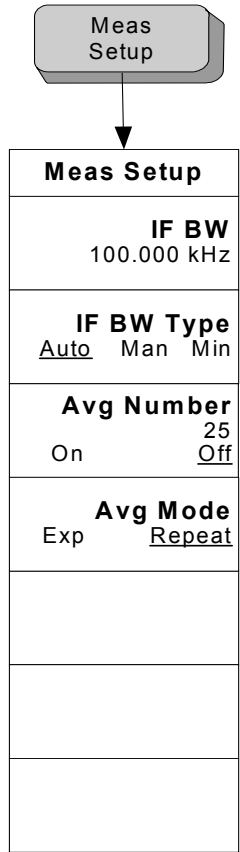

< Meas_Setup_Mod_Rate >

Figure 6-31 Modulation SINAD Amplitude Selection Key Flow (1 of 2)

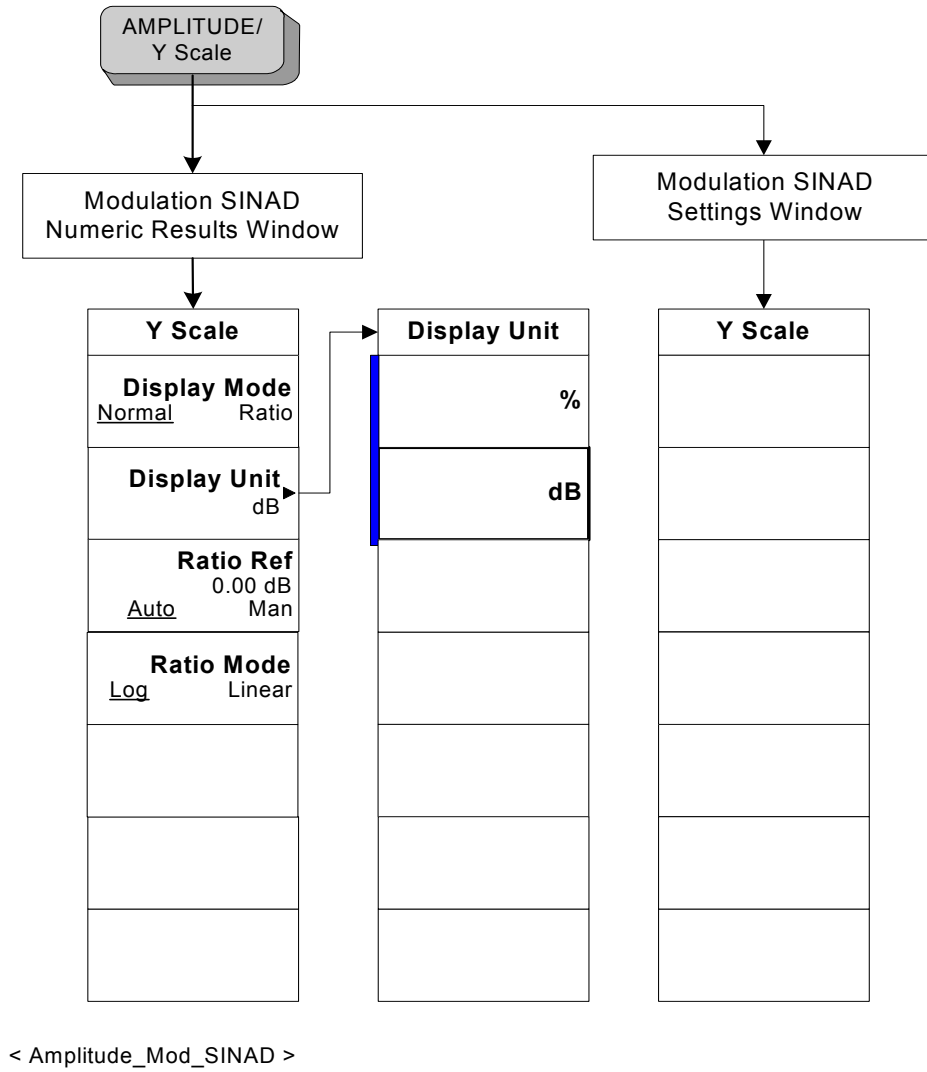
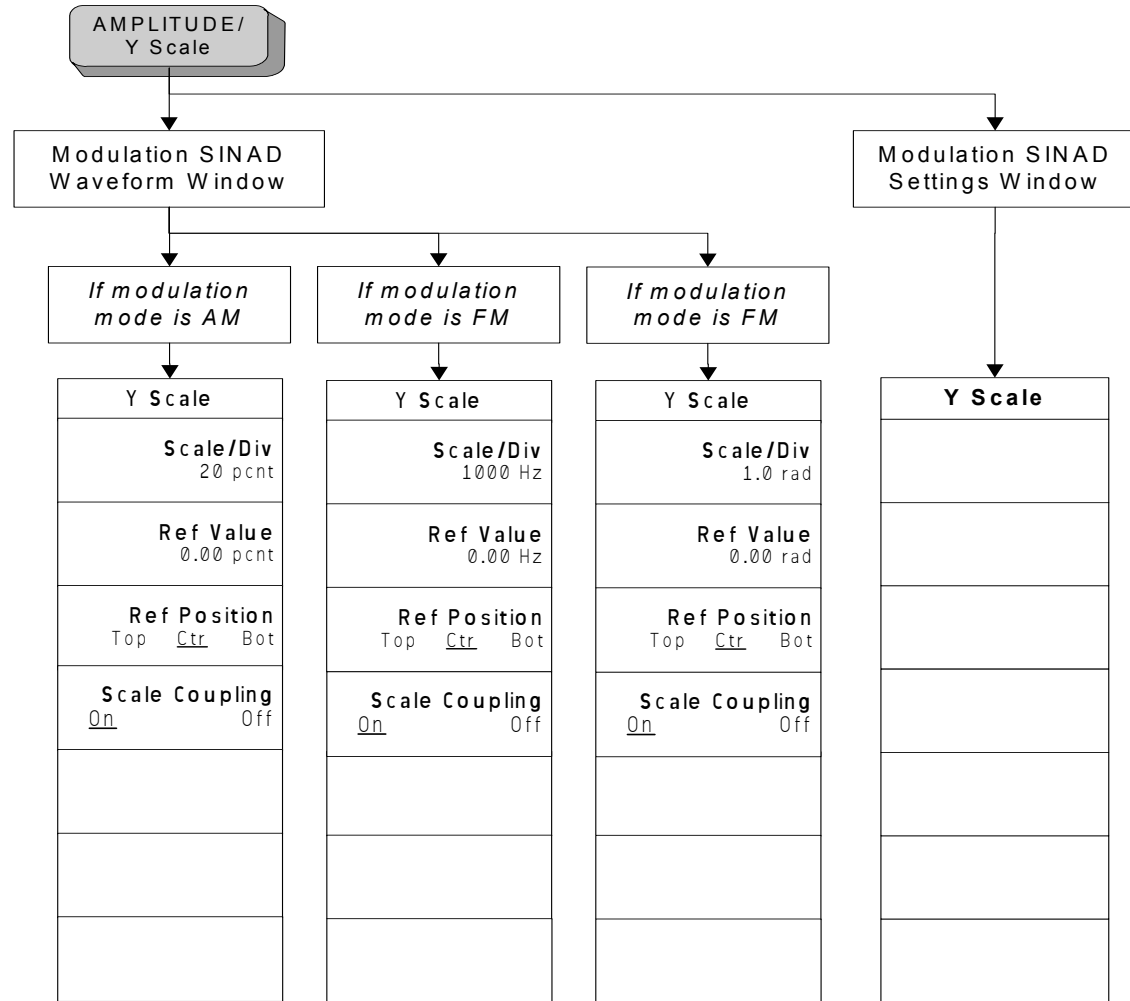
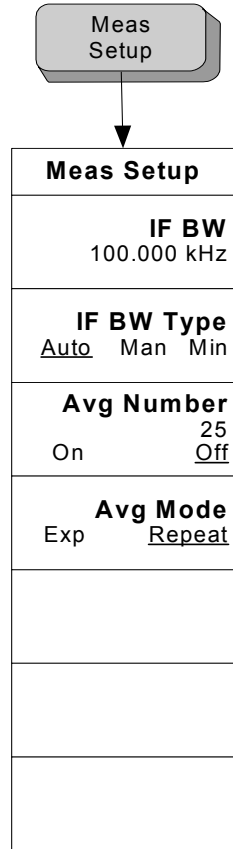

Figure 6-32 Modulation SINAD Amplitude Selection Key Flow (2 of 2)



< Amplitude_Mod_SINAD_2 >

Figure 6-33 Modulation SINAD Measurement Setup Key Flow



< Meas_Setup_Mod_SINAD >

Figure 6-34 PM Deviation Amplitude Selection Key Flow

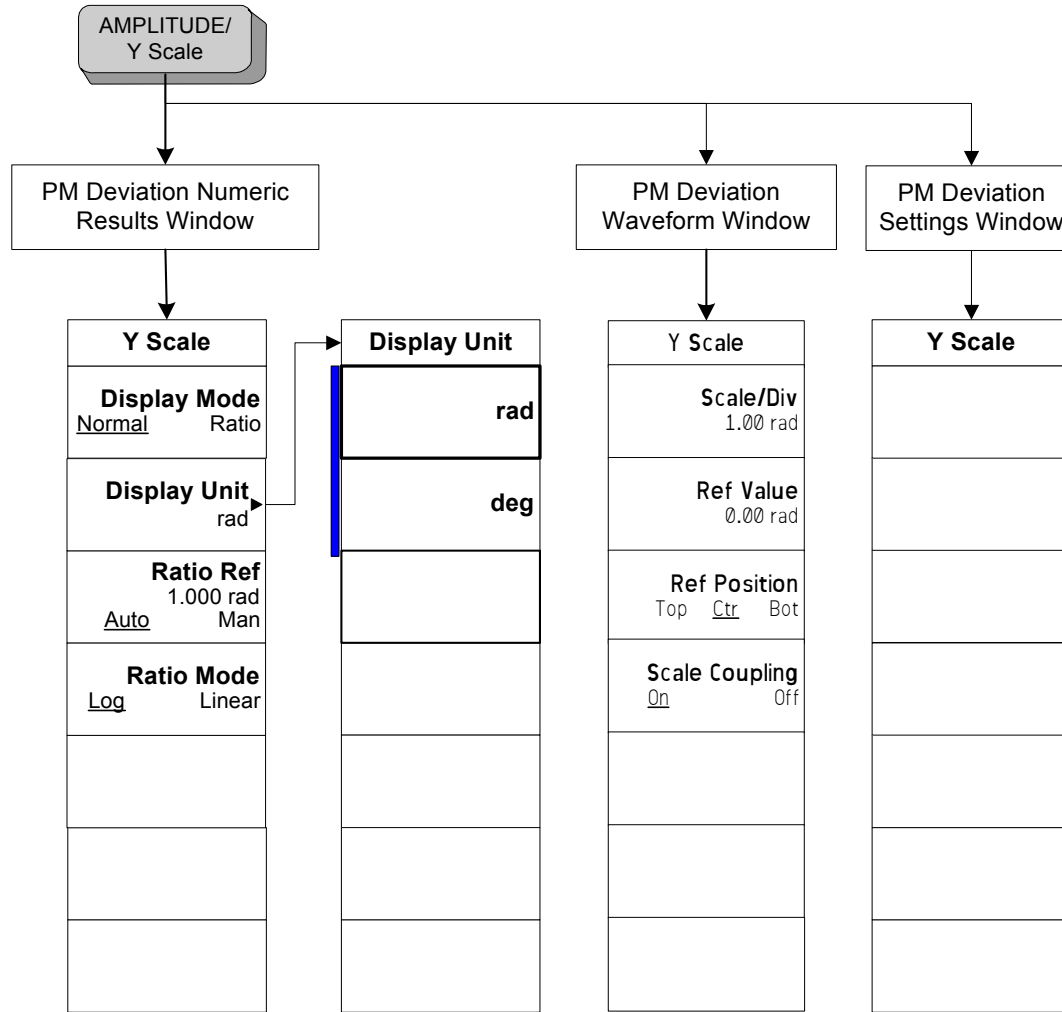

< Amplitude_PM_Dev >

Figure 6-35 PM Deviation Span Selection Key Flow

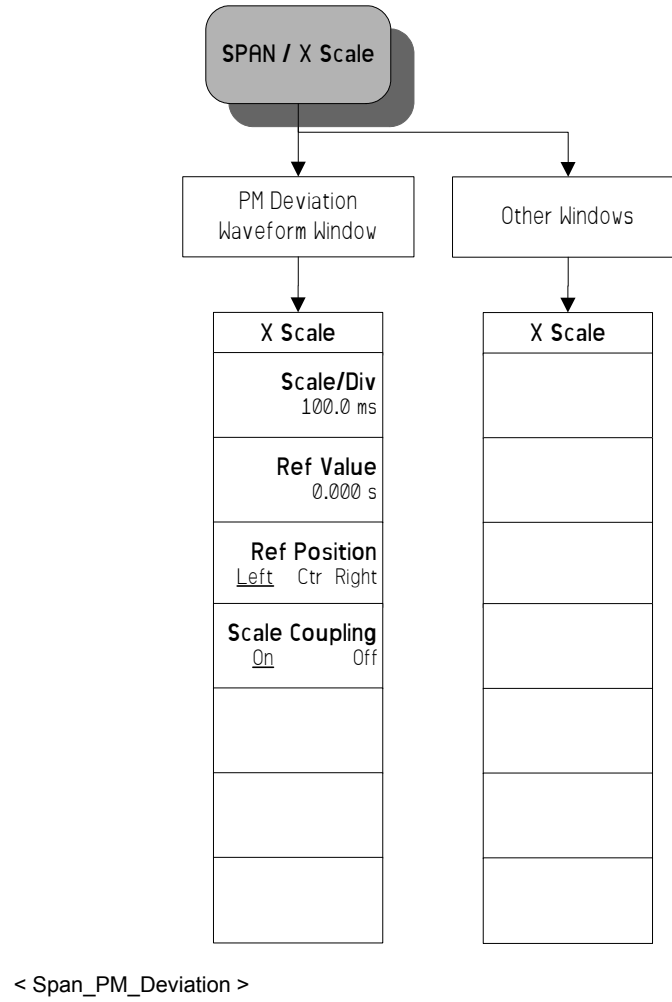

Figure 6-36 PM Deviation Measurement Setup Key Flow

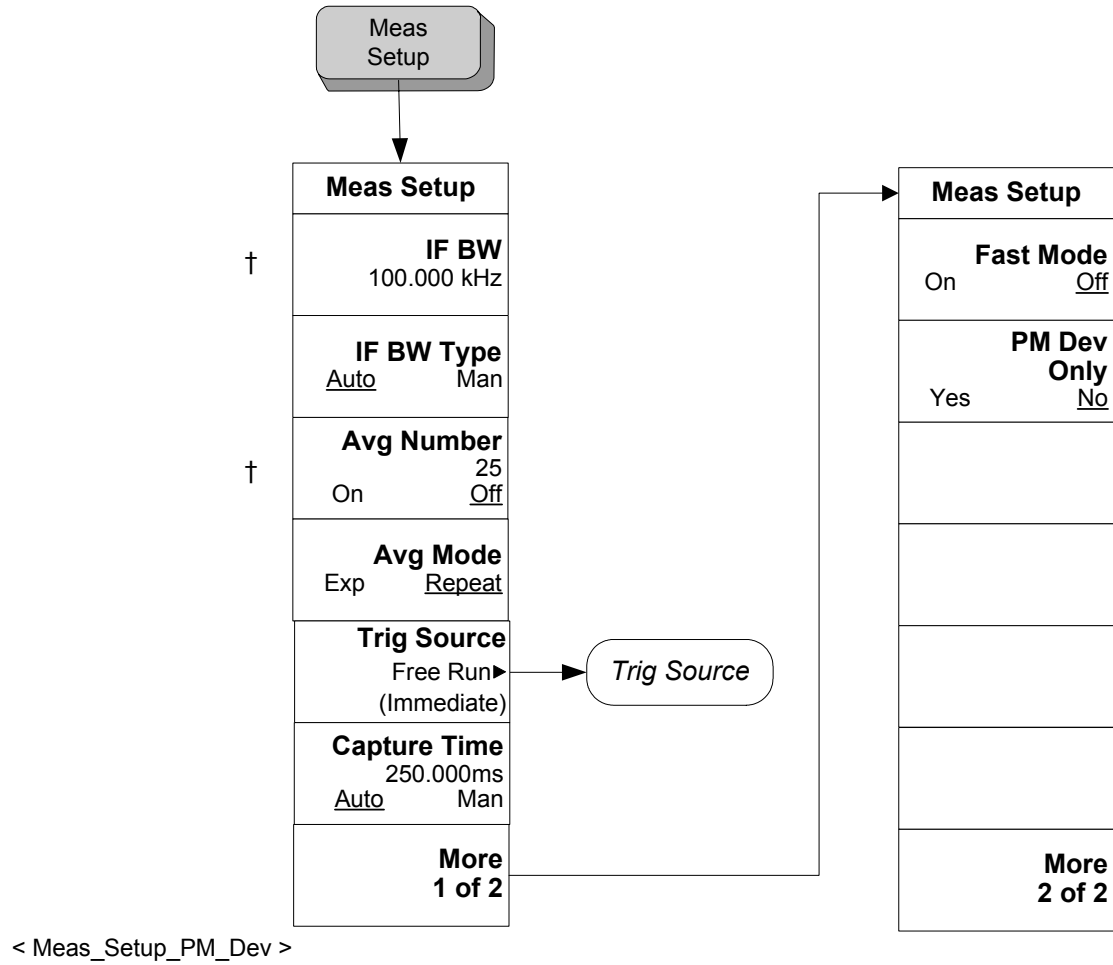

Figure 6-37 PM Deviation Trigger Source Key Flow

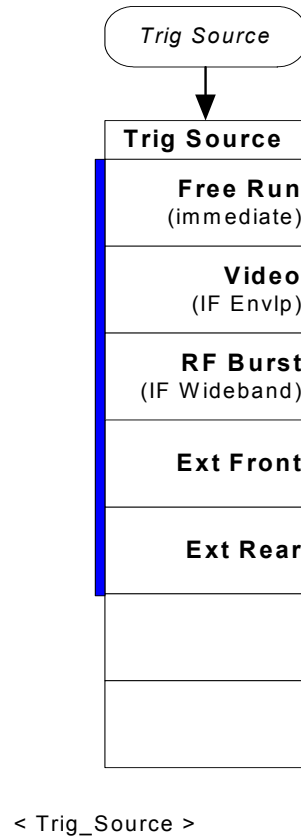

Figure 6-38 RF Power Amplitude Selection Key Flow

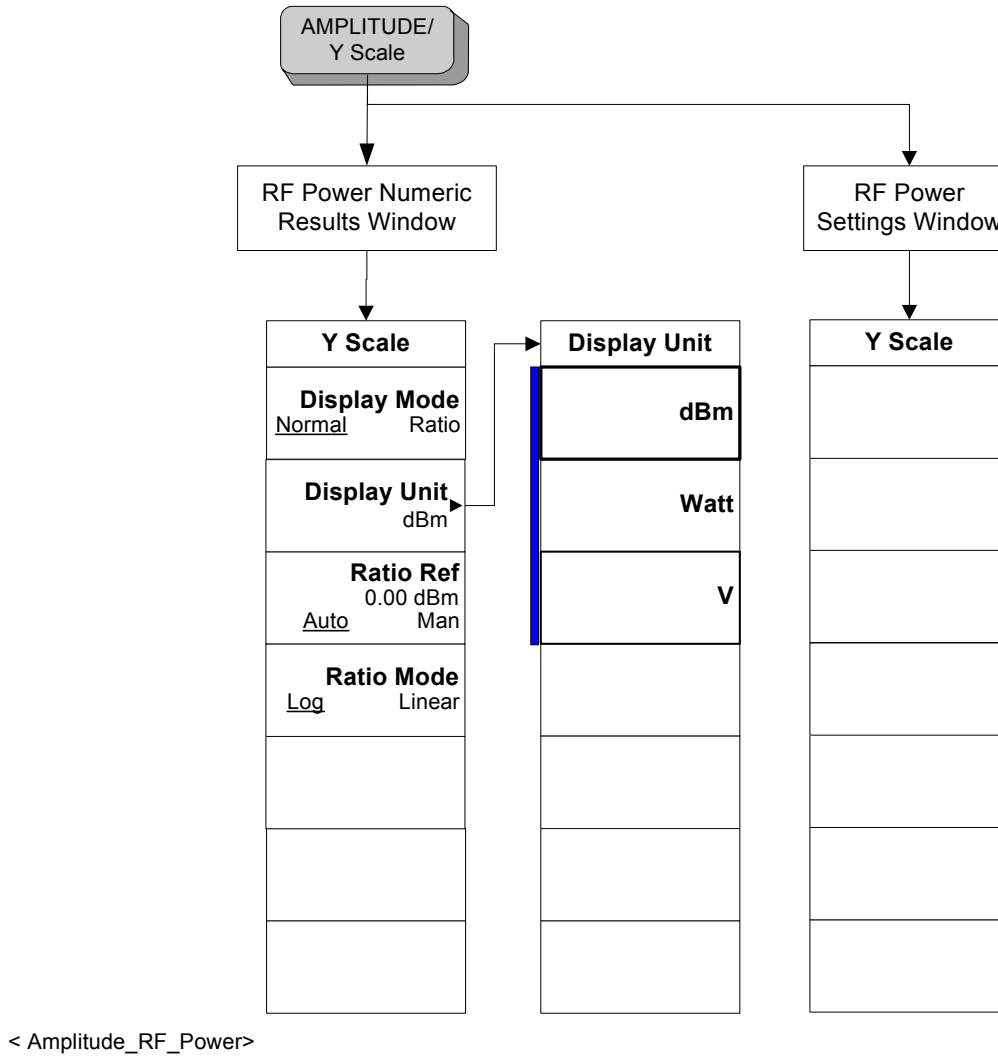
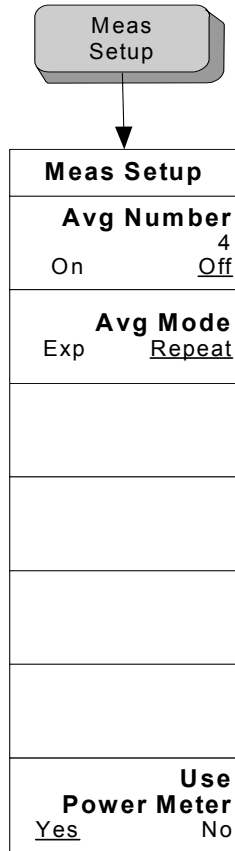
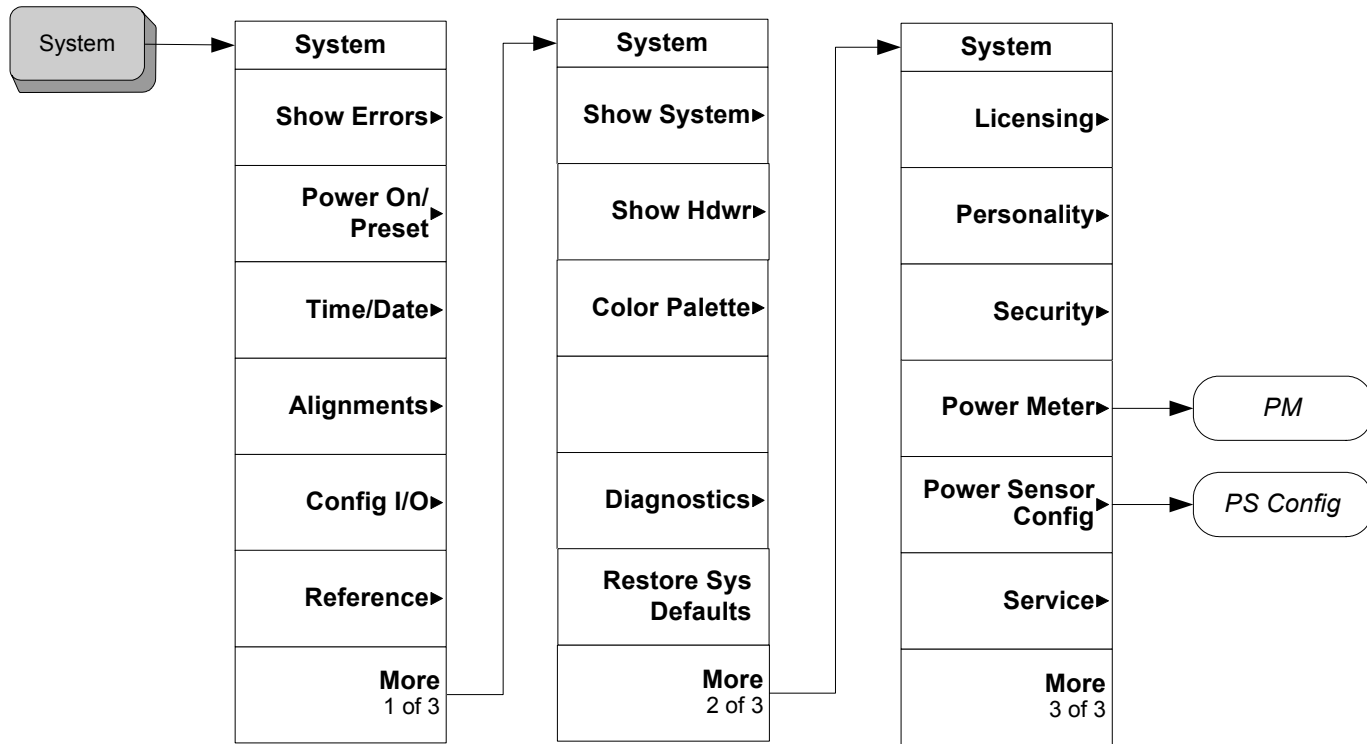

Figure 6-39 RF Power Measurement Setup Key Flow



< Meas_Setup_RF_Power >

Figure 6-40 System Setup Key Flow (1 of 4)



< System_PM&PS_Config >

Figure 6-41 System Setup Key Flow (2 of 4)

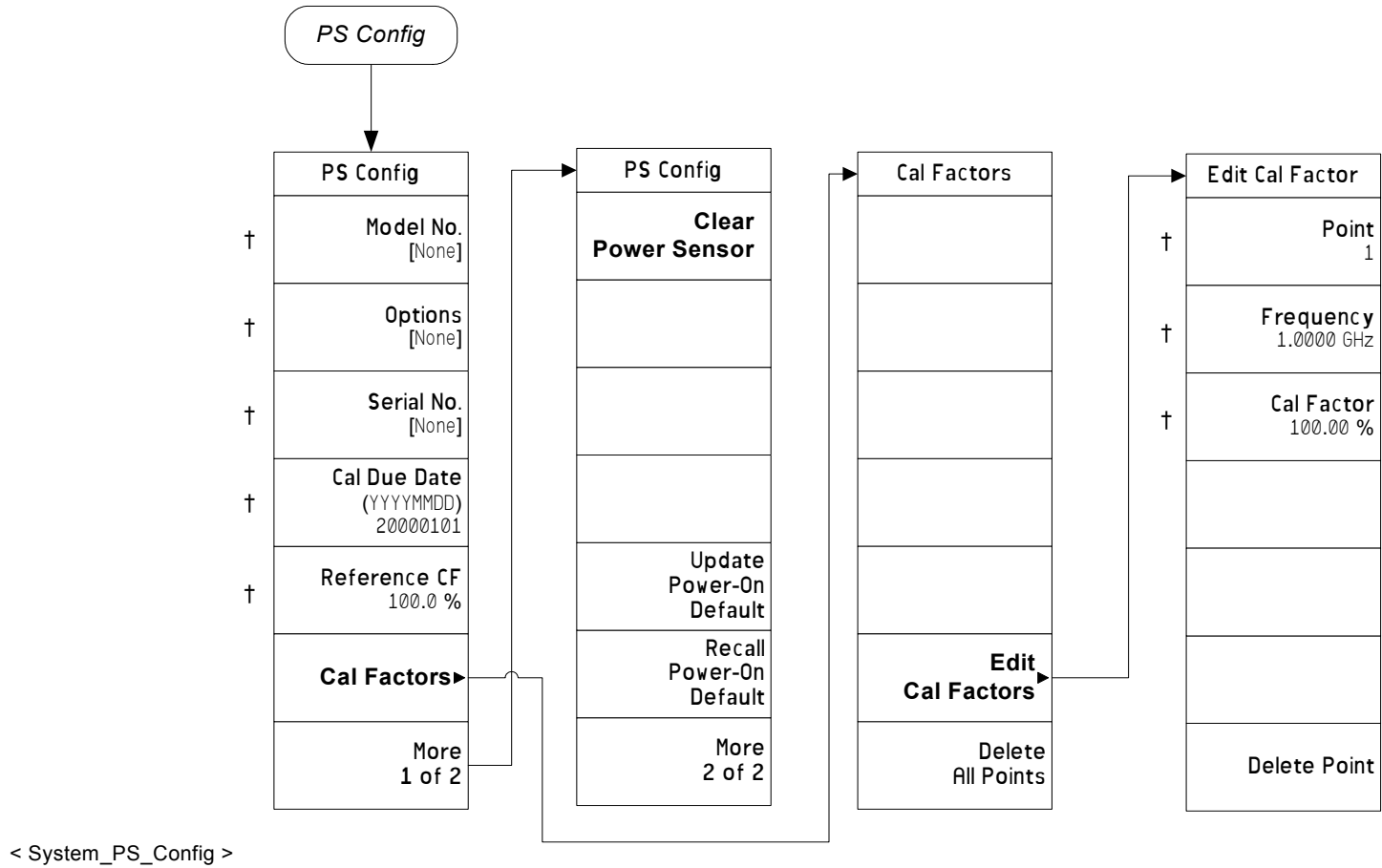
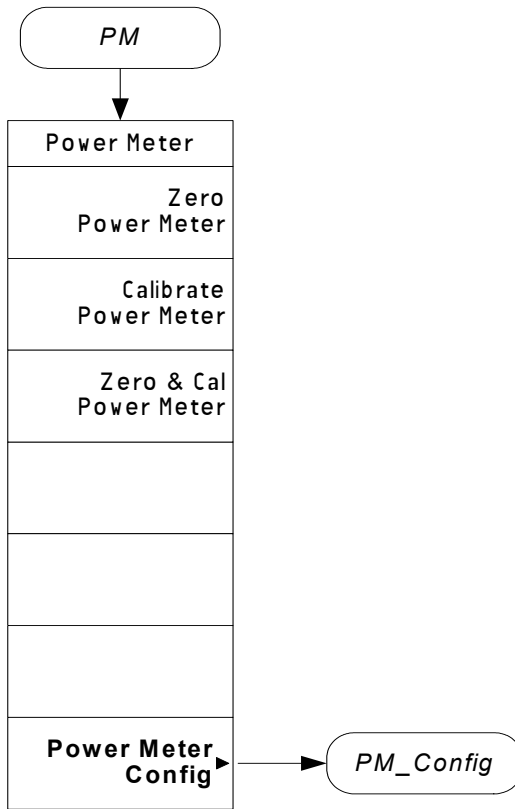

Figure 6-42 System Setup Key Flow (3 of 4)



< System_PM >

Figure 6-43 System Setup Key Flow (4 of 4)

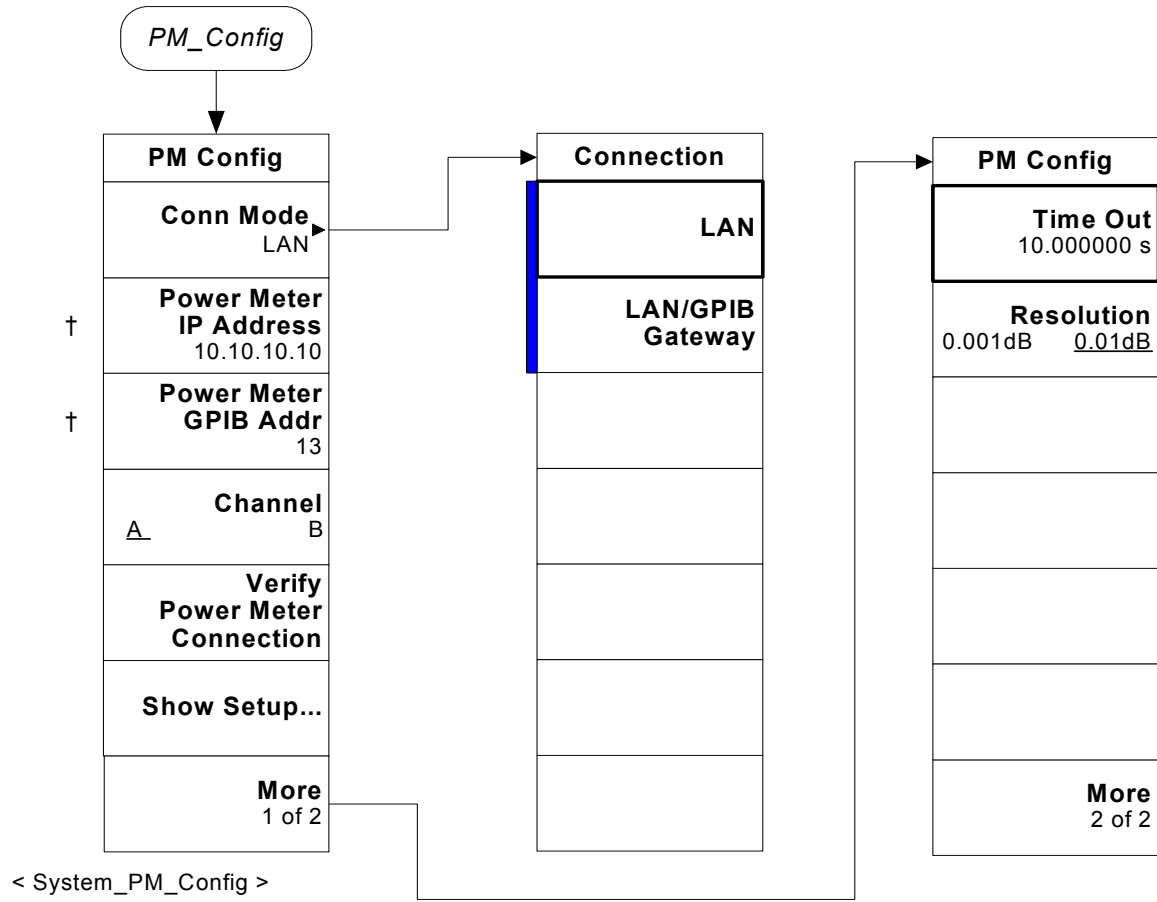

Figure 6-44 Trace/View Key Flow

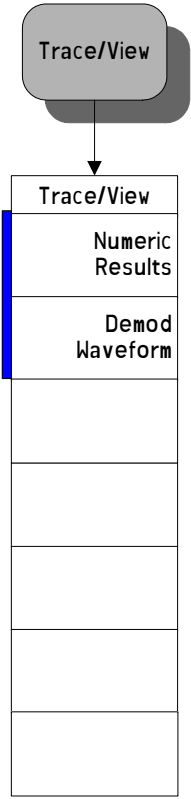
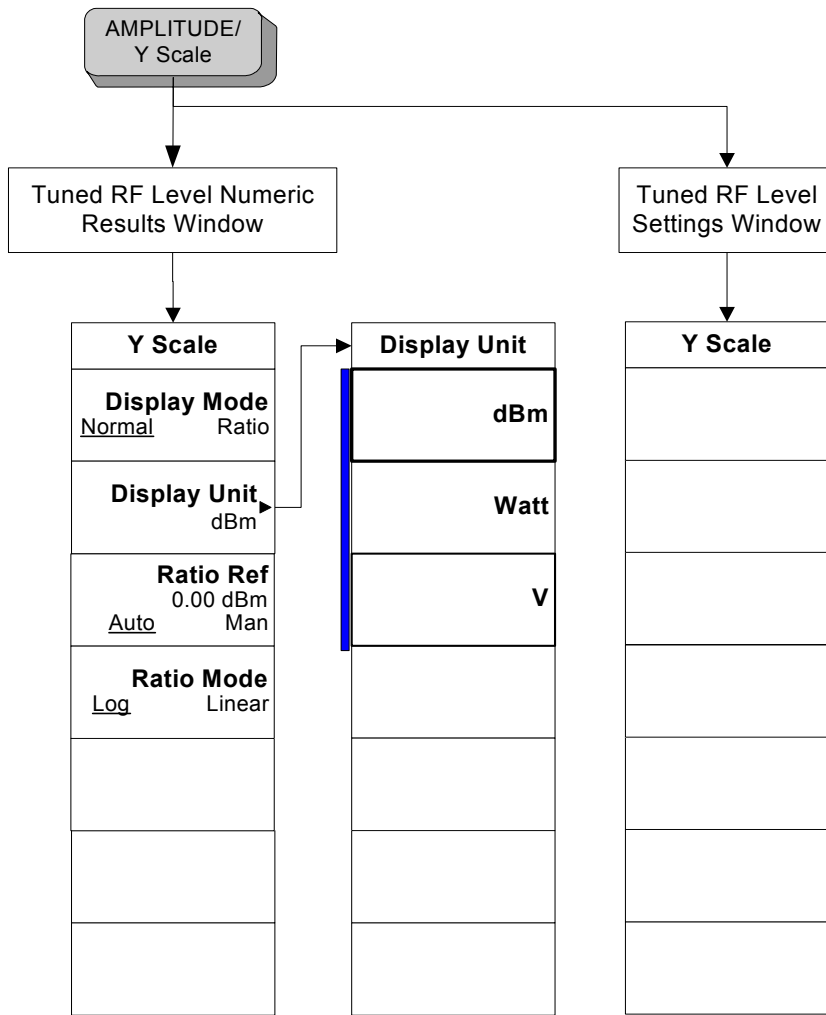
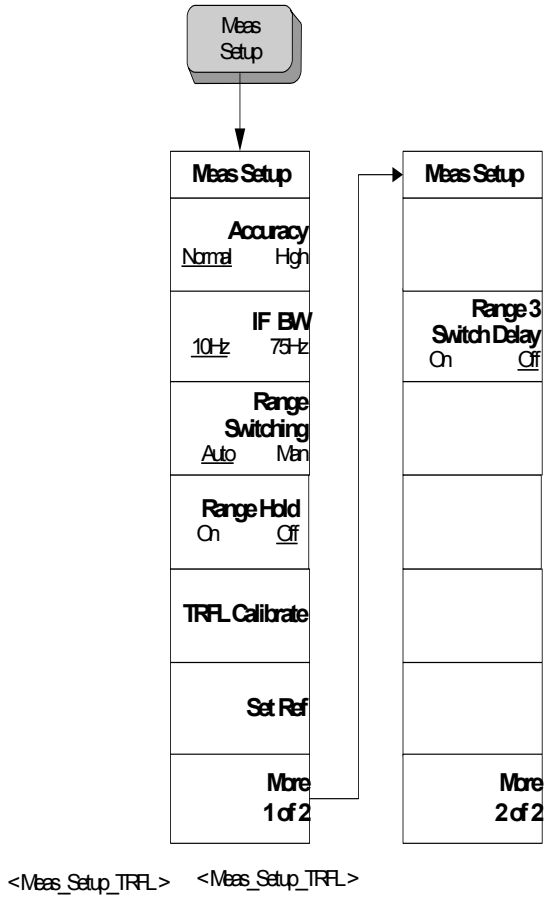

Figure 6-45 TRFL Amplitude Selection Key Flow



_TRFL >

Figure 6-46 TRFL Measurement Setup Key Flow



7**PC User Interface Measurements**

This chapter provides the information needed to make measurements using the PC User Interface. Instructions to help you set up and perform the measurements are provided, and various measurement examples are shown.

Introduction

Option 233 PC User Interface Software is designed to provide PC-based control to make Measuring Receiver measurements on RF and audio signals. It makes the same measurements as the Option 233 PSA-embedded personality does. See [“Measuring Receiver Measurements”](#) on page 60.

Installation and Setup (for PC User Interface only)

This chapter provides the following information that you may need when you first receive your Measuring Receiver System:

- “Setting up the System Hardware” on page 349
- “Installing the Option 233 PC User Interface Software” on page 350
- “Calibrating System Components” on page 48
- “Verifying the Software Installation” on page 354
- “Protecting Against Electrostatic Discharge” on page 57

Figure 7-1 N5531S Measuring Receiver System

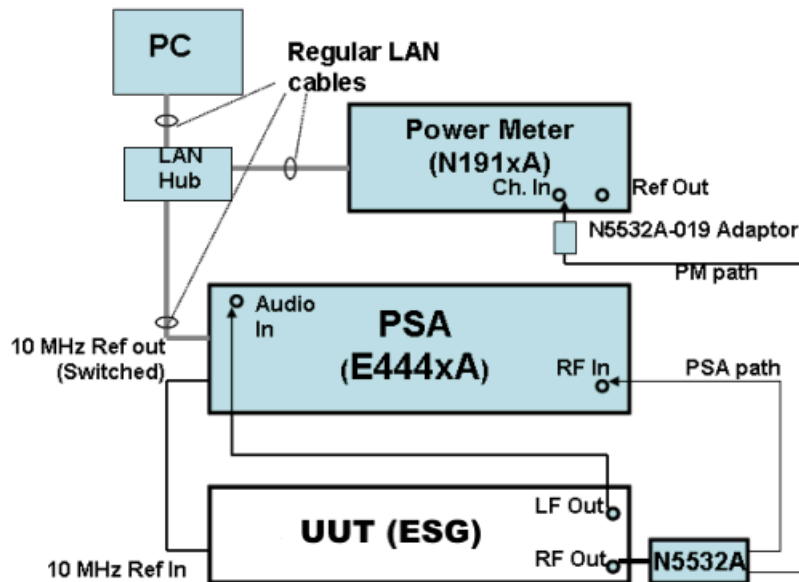

Setting up the System Hardware

Figure 7-1 on page 349 shows the hardware setup for the Option 233 PC User Interface System. The system is based around the PSA spectrum analyzer, a P-Series power meter, a N5532A Sensor Module and the PC Software. Follow the above diagram to connect the system hardware and refer to “System Hardware Connections” on page 40:

1. Connect LAN cable to the PSA, the Power Meter and the PC.
2. Connect the Sensor Module to the PSA and the Power Meter.
3. Connect the RF input of the Sensor Module to the DUT RF output.
4. Connect power cords to the PC, PSA and Power Meter.

5. Apply power to the PC, PSA and Power Meter, then observe their self-tests.

Installing the Option 233 PC User Interface Software

The software running on a PC equipped with a LAN interface handles the user interface and all instrument control. For remote programming, the software uses an industry-standard IVI-COM application-programming interface (API).

A free PC User Interface Software CD is provided with every option 233 purchase. The CD contains all the software necessary for making measurements.

You can also download the software from Agilent web page.

Step 1. Make sure that the host PC has the necessary PC Requirements. See [Table 7-2](#) and [Table 7-3](#).

Step 2. Check for any existing N5530S or N5531S installed on the PC, and if found, remove it.

1. On the PC screen taskbar, select **Start > Programs**.
2. Look for the program listed as **Agilent N5530S Measurement Receiver**, or **Agilent N5531S Measurement Receiver**.
3. If any N5530S or N5531S found, on the PC screen taskbar, select **Start > Settings > Control Panel**.
4. In the **Control Panel** window, select **Add/Remove Programs**.
5. In the **Add/Remove Programs** window, select N5530S or N5531S and then select **Remove**.

Step 3. Start the Agilent install script by:

1. Entering the CD into the computer, in most cases the installation program will automatically run.

If it does not run, you can make it run by going to the **Start** button on the PC display task bar. Select **Start->Run** and type "F:\Setup.exe" in the dialog box. Please use the correct drive name for your CD in the run command.

Figure 7-2 Preparing to Install

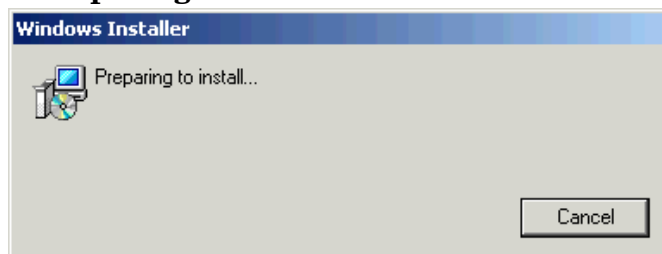

This screen will appear for a few seconds followed by:

Figure 7-3 Welcome to the N5531S Setup Wizard



2. Press Next.

Figure 7-4 License Agreement



3. This window provides information on the Licensing Agreement:

- Select the **I Agree** radio button.
- Select **Next**.

Figure 7-5 N5531S Information

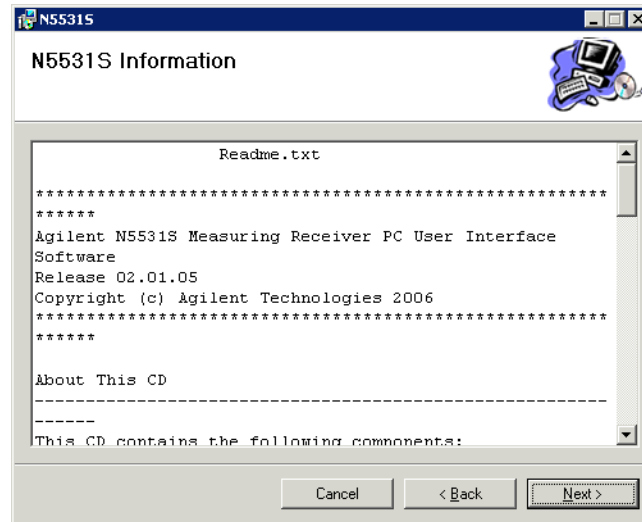

4. This window provides “Read Me” information about the N5531S software, select Next to continue.

Figure 7-6 Select Installation Folder

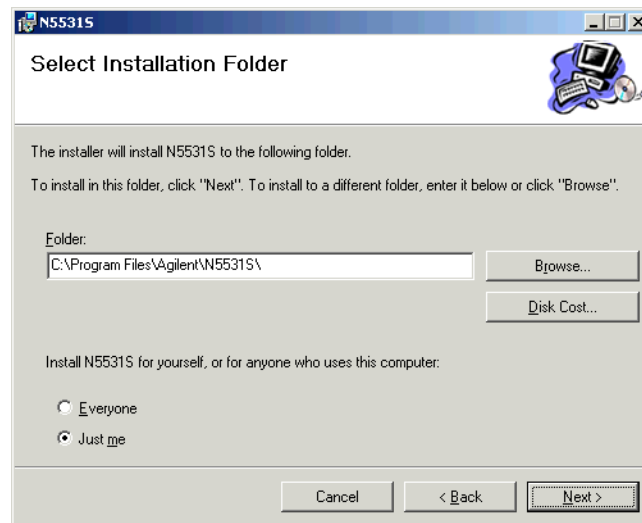

5. This window enables browsing to a folder in which to install the software. Choose between Everyone and Just me:
 - Choose between **Everyone** and **Just me**:
 - Select **Browse** to navigate to a folder other than the folder already selected.
 - Select **Next** to continue.

Figure 7-7 Confirm Installation

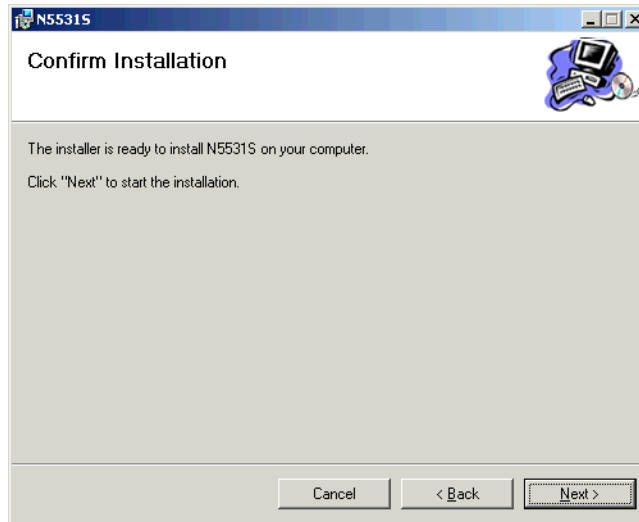

6. Press Next to start the installation.

Figure 7-8 Installing

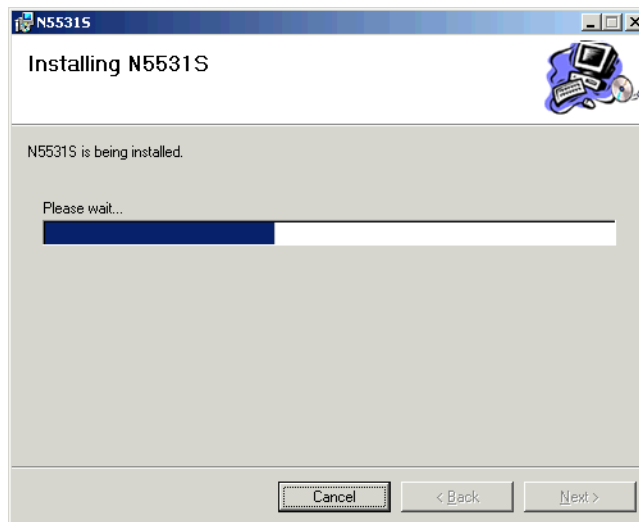

7. This window shows the progress of the software installation. When the installation is complete, Press **Next**.

Figure 7-9 Installation Complete

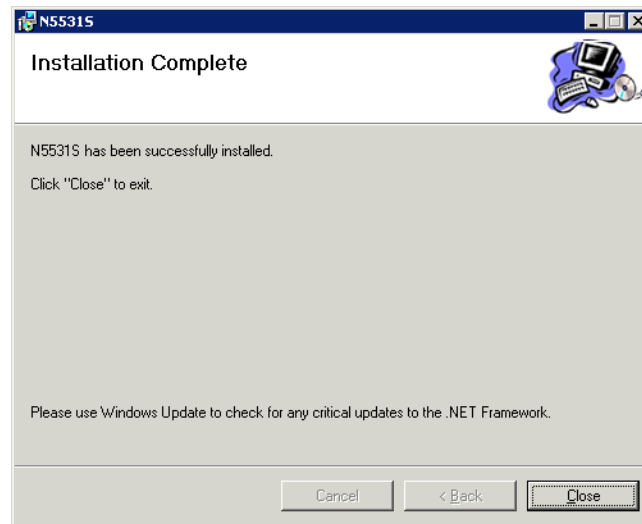

8. This window shows that the installation is complete.
 Select **Close** to close the window.

Verifying the Software Installation

With the hardware and software installed, it is now time to test the system in preparation for making measurements.

1. Apply power to the PC, PSA, UUT (signal generator), and power meter (PM), and allow them to warm up for at least five minutes.
2. After the measuring instruments are turned on and ready, start the N5530S program by:
 - Double clicking the **N5531S** icon if it is available on the desktop.
 - Or,
 - On the PC screen taskbar, select **Start > Programs > Agilent N5531S Measuring Receiver Software**.
3. The N5531S program will start up in the **Standard View**. If you don't have a PSA connected and configured, you may have an error as follows, select **OK**.

Figure 7-10 Running without PSA connected

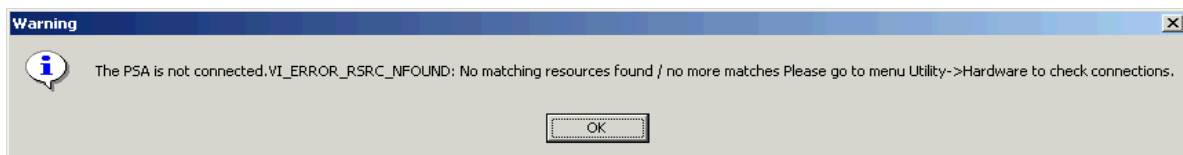

After initializing and configuration, the system will automatically make a Frequency Counter measurement as shown here.

Figure 7-11 Standard View

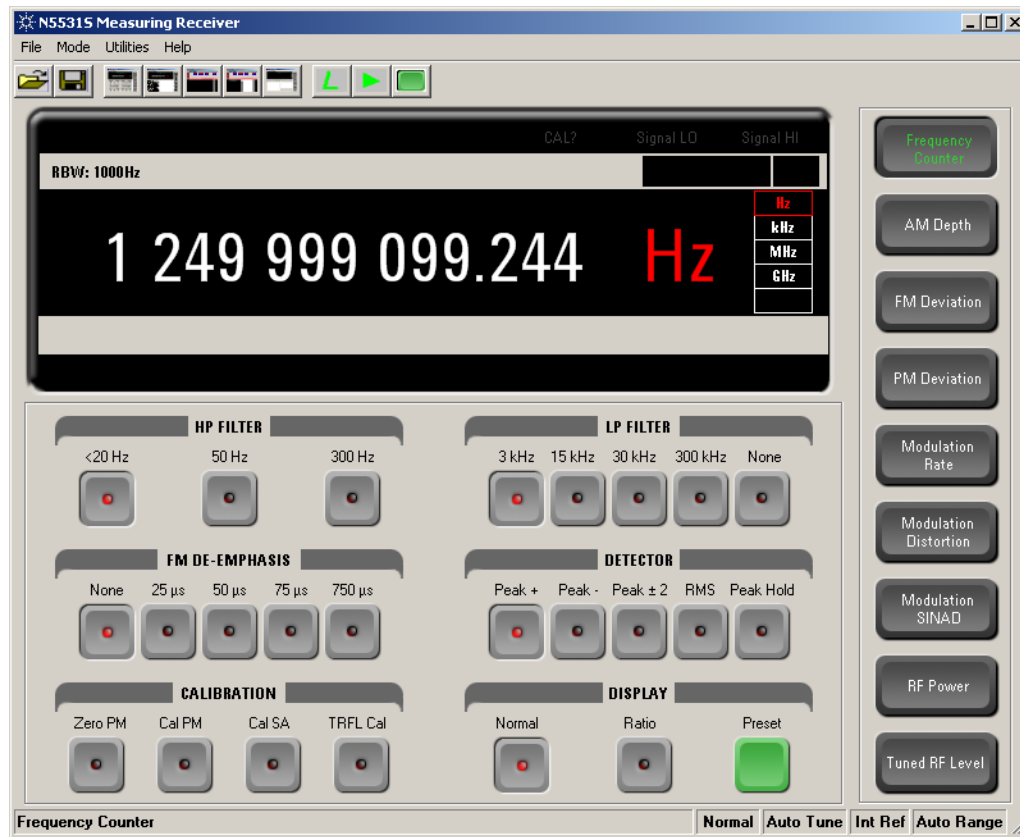

NOTE

The measurement display will probably not show a valid measurement reading, as the DUT or the system connections may not be set up correctly.

If you have problems

Check that the PSA or Power Meter is connected by selecting **Utilities** in the program **menu bar**.

Figure 7-12 Selecting Utilities

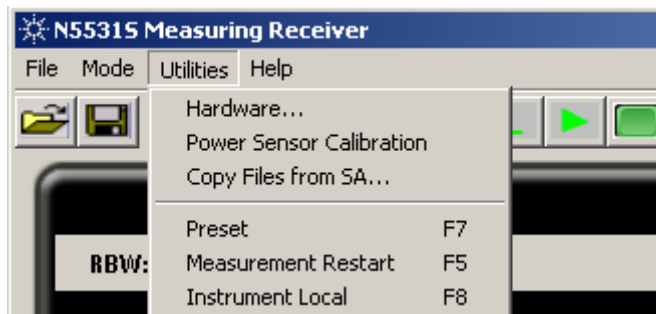

Selecting **Hardware...** will bring up a **Hardware Connections** dialog

PC User Interface Measurements
 Installation and Setup (for PC User Interface only)

box.

Figure 7-13 **Hardware Dialogue Box**

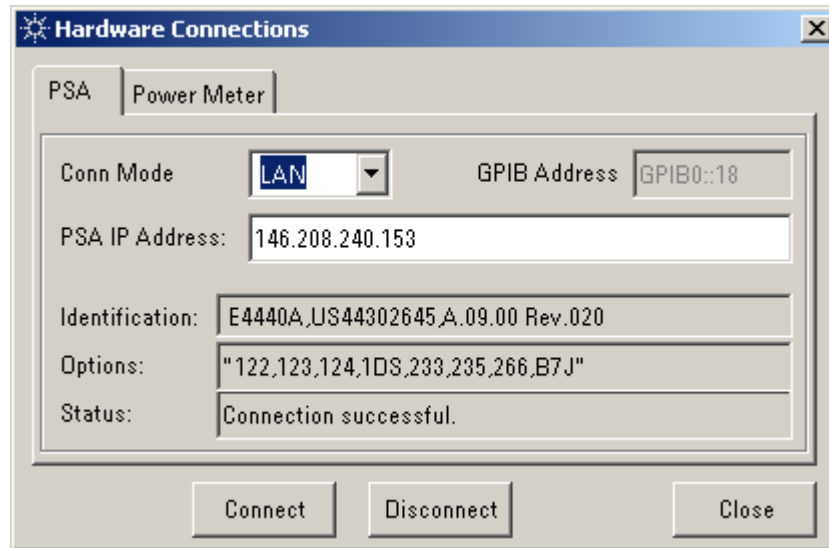

For Help information, select **N5531S Help** in the Help menu:

Figure 7-14 **Help**

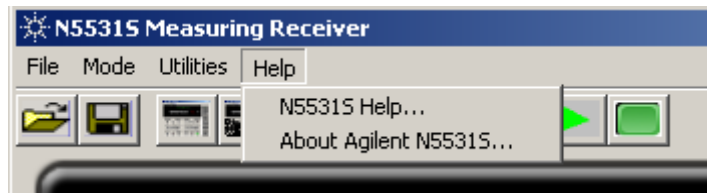

NOTE

For more information about configuring the system and making measurements on PC User Interface, see PC User Interface Online Help.

Using a GPIB Power Meter in the System

Update for N5530S Users

The N5530S Measuring Receiver only supported GPIB power meters, and most N5530S users will want to update to the N5531S system. The N5531S system is designed to communicate with the Agilent P-Series power meter via a LAN connection. However, there are 3 different ways to allow a GPIB power meter to be used on the N5531S system.

- A. emulating a LAN/GPIB gateway using the 82357A USB/GPIB interface with your PC and the Agilent IO Library Suite.
- B. emulating a LAN/GPIB gateway using a PC that has a GPIB card and the Agilent IO Library Suite.
- C. using the E5810A LAN/GPIB Gateway.

NOTE

For A and B, please ensure that your PC has the latest version of the Agilent IO Libraries Suite, which is available for download at www.agilent.com/find/find/iosuite.

Power Meter Requirements

Table 7-1 Power Meter System Requirements

System Component	Model numbers supported
Economy Power Meter with a LAN/GPIB Gateway	E4416A Firmware Revision A1.04.00 or later E4417A Firmware Revision A2.04.00 or later E4418B Firmware Revision A1.08.00 or later E4419B Firmware Revision A2.08.00 or later

PC Requirements

Table 7-2 Optional: PC Hardware System Requirements

Personal Computer Hardware	<p>≥ 1 GHz Pentium or equivalent</p> <p>256 Mbytes RAM (512 Mbytes recommended)</p> <p>Minimum 100 Mbytes available space on hard drive</p> <p>CD ROM drive for the installation media (can be installed via network access)</p> <p>LAN interface</p>
----------------------------	---

Table 7-3 Optional: PC Software System Requirements

Personal Computer Software	<p>Operating system: WinXP Professional</p> <p>Agilent I/O Libraries Suite /4.2 or later</p>
----------------------------	--

Figure 7-15 Hardware Setup Block Diagram

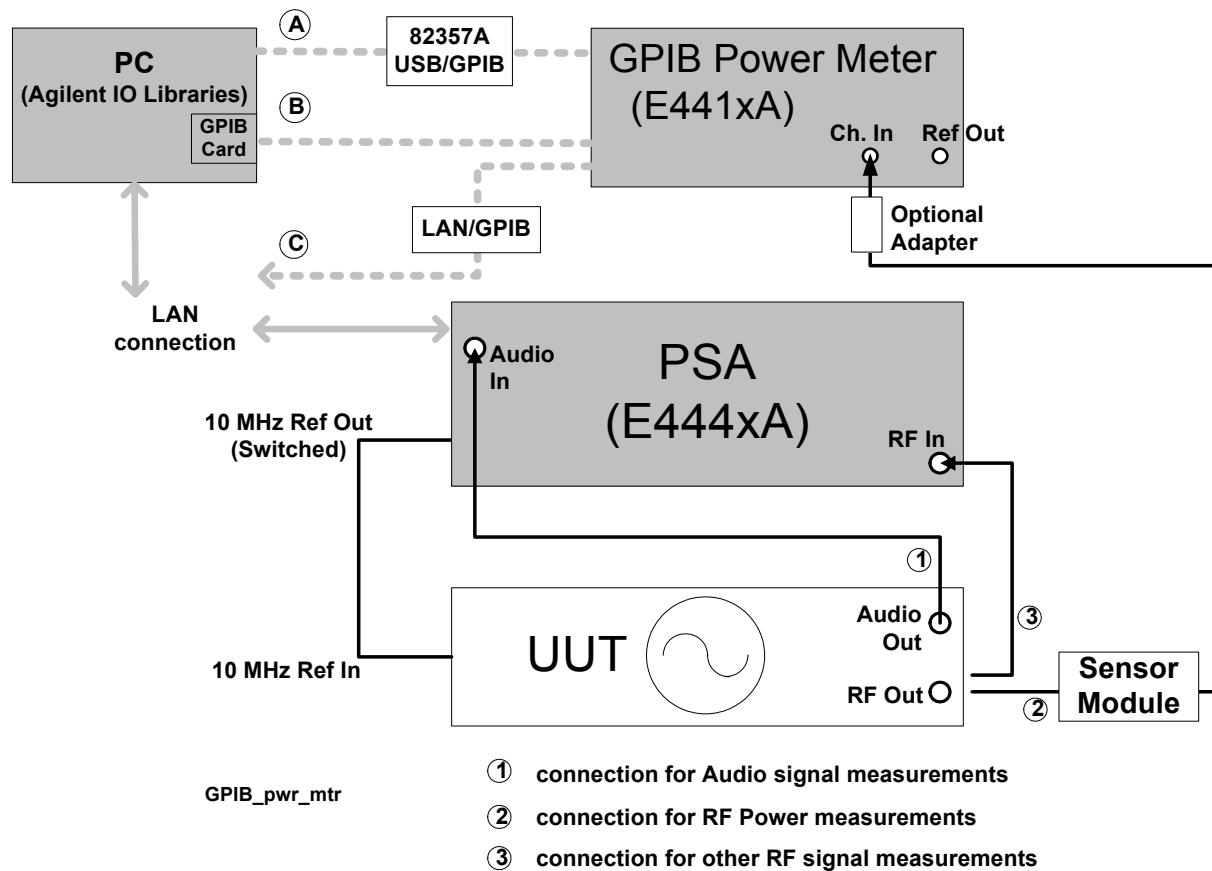

Step 1. Connect the system components as shown in the above figure, using the LAN to GPIB configuration that you have available.

Step 2. Apply power to the PSA, EPM Power Meter and UUT. Wait until the PSA and EPM self-tests complete.

Step 3. Configure the power meter.

Press **System, GPIB** to verify the power meter GPIB address. To change the address, press **GPIB Address** and use the up/down keys to select the address. Press **Enter** to complete the change process.

Step 4. Configure LAN/GPIB interface by doing one of the following:

A. If you are using the Agilent 82357A/B USB/GPIB interface with your PC:

On the PC press **Start** and select **All Programs, Agilent IO Library Suite, Agilent Connection Expert**.

Press **Refresh All** to have the Connection Expert automatically discover your power meter on the 82357A/B USB/GPIB interface.

Note that when you click on the power meter entry in the table “Instrument I/O on the PC”, the Connection Expert will send an IDN query to the instrument and will put a green checkmark on the power meter entry showing successful communication

B. If you are using a PC and GPIB card to emulate a LAN/GPIB gateway:

The GPIB card must be fully installed in the PC.

On the PC press **Start** and select **All Programs, Agilent IO Library Suite, Agilent Connection Expert**.

Press **Refresh All** to have the Connection Expert automatically discover your power meter on the GPIB bus.

Note that when you click on the power meter entry in the table “Instrument I/O on the PC”, the Connection Expert will send an IDN query to the instrument and will put a green checkmark on the power meter entry showing successful communication

C. Using the Agilent E5810A LAN /GPIB Gateway.

With the gateway power off, connect a GPIB cable from the gateway to the power meter.

If you are connecting the gateway directly to the PSA (and NOT through your site LAN) a cross- over cable is required when connecting the PSA to the gateway. A cross-over cable is a CAT5, RJ-45 with cross pinning. These are available from computer stores or from Agilent as part number 8121-0545. Each PSA ships with one

PC User Interface Measurements

Using a GPIB Power Meter in the System

of these cross-over cables.

If you are connecting to a PSA that is already connected through a LAN hub, you should connect the gateway to the same LAN hub the PSA is connected to with a normal LAN cable.

Apply power to the gateway. The gateway will search for a DHCP server. If the gateway is connected to your site LAN and finds a DHCP server, an IP address will be displayed. If the gateway is connected to the PSA via a cross over cable, the gateway will default to a LAN address such as 169.254.58.10.

Step 5. Configure the system parameters on the PSA:

1. Press **Mode**, select **Measuring Receiver**.
2. **If using a PC with 82357A/B USB/GPIB interface to emulate a LAN/GPIB gateway:**

Start the remote IO server on the PC by pressing **Start** and select **All Programs, Agilent IO Library Suite Utilities, Remote I/O Server**.

If using a PC with GPIB card to emulate a LAN/GPIB gateway:

Start the remote IO server on the PC by pressing **Start** and select **All Programs, Agilent IO Library Suite Utilities, Remote I/O Server**.

If using the E5810A gateway with a cross over cable:

On the PSA press **System, Config I/O, IP Address**. Set the PSA IP address to one value greater than the LAN address shown on the Gateway. For example if the gateway is at address 169.254.58.10, set the PSA IP address to 169.254.58.11.

Press **Subnet Mask** and enter the subnet mask. For the IP address above, enter 255.255.0.0

If using the E5810A gateway and PSA connected to a LAN hub:

Since the PSA is already configured on the LAN, the IP address, Subnet Mask and Gateway Address do not require reconfiguration. Continue at step 3.

3. Press **System, More, More, Power Meter, Power Meter Configuration** keys.
4. Press **Conn Mode** to select **LAN/GPIB Gateway**.

5. **If using a PC with 82357A/B to emulate a LAN /GPIB Gateway**, press the **Gateway IP Address** and enter the IP address of the PC. The IP address of the PC can be discovered by pressing **Start, Run**, type the letters cmd in the dialog box, click **OK**. When the window appears, type ipconfig and press **Enter**.

If using a PC with a GPIB Card to emulate a LAN /GPIB Gateway, press **Gateway IP Address** and enter the IP address of the PC. The IP address of the PC can be discovered by pressing **Start, Run**, type the letters cmd in the dialog box, click **OK**. When the window appears, type ipconfig and press **Enter**.

If using the Agilent E5810 LAN /GPIB Gateway, press the **Gateway IP Address** and enter the IP address shown on the Gateway display.

- Step 6.** Press the **Power Meter GPIB Address** key and enter the GPIB address of your power meter. To determine the power meter GPIB address on the Agilent E4418 or E4419A power meters, press **System/Inputs, GPIB** on the power meter front panel.
- Step 7.** Press the **Verify Power Meter Connection** key. The grayed-out **Show Setup** key will be enabled when the connection between the PSA and the power meter is established.
- Step 8.** Select the power meter channel number you would like to use by toggling the **Channel** key. If the power meter has only one channel, this key is grayed out.
- Step 9.** Press the **Show Setup** key to display and verify the power meter configuration information.
- Step 10.** You can set the desired time-out for your testing by pressing **Power Meter Config, More, Time Out** keys.
- Step 11.** Press **Power Meter Config, More, Resolution** to select the resolution as 0.001 dB or 0.01 dB.

PC User Interface Measurements
Using a GPIB Power Meter in the System

8

**N5531S Measuring Receiver
Performance Verification**

Performance Verification Tests

The design, specifications and support of the Agilent N5531S Measuring Receiver System relies on the spectrum analyzer, power meter and sensor modules meeting their normal specifications. A N5531S system calibration is not required. If each instrument is tested separately and passes all specification verification testing, when the instruments are combined as a system; system specifications are guaranteed. Most system specifications are tied directly to the spectrum analyzer specifications. Only the RF Power Level and Absolute TRFL measurements use the power meter and the sensor modules.

Agilent service centers have calibration software for each instrument in the system. Customers can purchase a copy of this software for the spectrum analyzer and the power meter.

Specifications were developed by modeling the system, deriving performance from the published instrument specifications for the individual instruments, and applying an error budget for each instrument. Bench testing was performed to verify the modeling and specification derivation is correct.

NOTE

When performing measurements it is very important for the user to refer to the Measuring Receiver Specification footnotes. The footnotes explain instrument settings and measurement guidelines required to provide specified measurement results.

Although the measuring receiver specifications are guaranteed by design and no measuring receiver testing is required, there may be a need to verify the Tuned RF Level specification. The following procedure outlines how to verify the linearity specification portion of TRFL and how to test TRFL over all three measurement ranges.

Linearity Verification

Definition

The spectrum analyzer which is part of the N5531S measuring receiver uses an ADC and digital signal processing to determine the level of a signal. Because traditional analog logarithmic amplifiers are not used, the accuracy of detection and linearity when measuring different signal levels is extremely good. Besides ADC linearity, spectrum analyzer stability and signal source stability are major contributors to meeting specification.

The following linearity test verifies the linearity specification in the Tuned RF Level section of the Measuring Receiver Specifications.

Specification

Linearity $\pm (0.009 \text{ dB} + 0.005 \text{ dB}/10 \text{ dB step})$

Specs apply to following conditions:

Frequency must be set manually. (Do not use the measuring receiver Frequency Count measurement).

Accuracy mode must be set to High.

Description

A highly calibrated step attenuator is used in conjunction with a highly stable signal source to provide signal levels to the measuring receiver.

The spectrum analyzer is placed in the Measuring Receiver mode, and the TRFL level measurement is selected.

The step attenuator is set to 0 dB and a reference measurement is taken.

The step attenuator is stepped from 0 to 50 dB and the amplitude at each step recorded.

The difference between the expected attenuation value as recorded on the step attenuator calibration report, and the measured value, is the linearity accuracy.

Table 8-1 Test Equipment

Instrument	Critical Specifications (for this test)	Recommended Model
Synthesized Signal Generator	Frequency 50 MHz Amplitude drift with temperature: Must not drift > 0.01 dB /degree C	Agilent E8257D with UNR or UNX (ultra low phase noise performance) and option 1EH, (Improved Harmonics below 2 GHz)
Calibrated Attenuator	0 to 50 dB range in 10 dB steps. Calibrated at a metrology lab at 50 MHz. VSWR at 50 MHz: <1.05:1 Example of calibration detail for the attenuator used in this test: “Using a dual-synthesizer, parallel IF-substitution method. NIST traceability achieved through a calibrated 1 kHz Ratio transformer. Cal frequency 50 MHz. A minimum of six measurements were made at each attenuator setting to find the mean value of “measured change in insertion loss” and to estimate the Standard Deviation of this Mean.” Also see Table 8-5, “Example Test Record,” for an example of calibrated attenuation and attenuator uncertainty values.	Agilent 8496G
10 dB Attenuator (2 each)	Used to minimize mismatch uncertainty. Connected to both ports of the step attenuator.	Agilent 8491A
Attenuator Switch Driver	Used to drive attenuator	Agilent 11713A
Cable, 3.5 mm (m) to 3.5 mm (m)	High quality cable that is repeatable (can be bumped or bent slightly and not cause measured value to change). DC to 26.5 GHz 92 cm (36 inches) Insertion loss ~2 dB	Agilent 8120-4921
Cable, BNC (m) to BNC (m)	For connecting time base of PSA to source 10 MHz input. 120 cm (48 inches long)	Agilent 10503A

Table 8-1 Test Equipment

Instrument	Critical Specifications (for this test)	Recommended Model
Adapters		
3.5 mm (f) to 2.4 mm (f)	For source output or PSA input on high frequency models	Agilent 11901B
3.5 mm (f) to 3.5 mm (f)	For output of 20 GHz source or input to E4440A opt BAB	1250-1749
Type N (m) to 3.5 mm (f) 2 or 3 required	For connection to fixed attenuators. Also, if PSA has type N input connector, this adapter is required	1250-1744

Test Setup

Figure 8-1 Linearity Measurement Test Setup

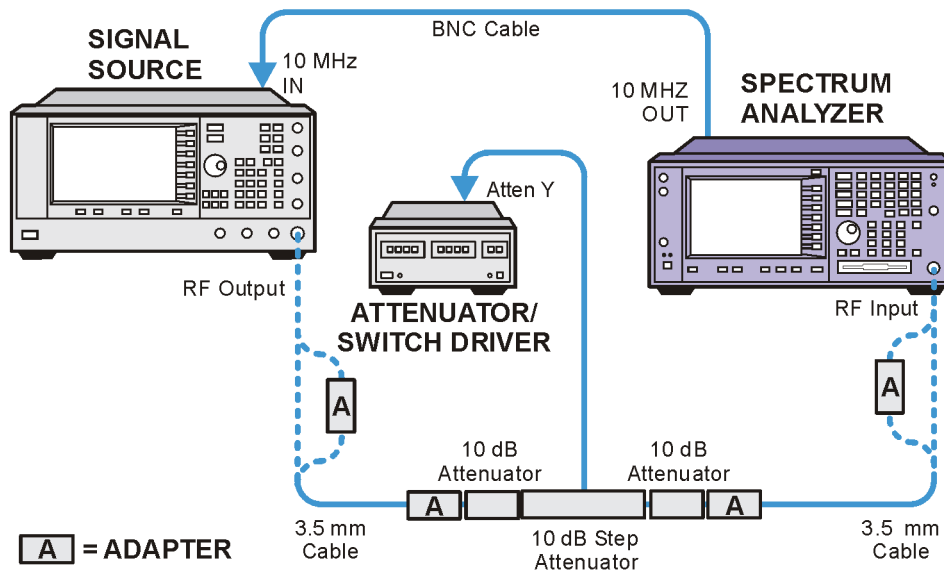

Test Procedure

1. See [Figure 8-1](#). When connecting equipment, assure proper connector care and connector torque settings are followed. SMA/3.5mm cable connectors are to receive 8 inch-pounds of torque. All connections must be cleaned with alcohol.
2. **Preset** the signal source and the PSA.
3. On the PSA, perform the **Auto Align** by pressing **System, Alignments, Align All Now**.

4. Initialize the test equipment parameters as follows:

Table 8-2 Signal Generator Settings

Parameter	Setting
Frequency	50 MHz
Level	+12 dBm
RF	On

Table 8-3 PSA Settings

Parameter	Setting
Mode	Measuring Receiver
Measure	Tuned RF Level
Frequency <i>Note: Do not use the Frequency Counter function. You must press the Frequency key and set the frequency manually.</i>	50 MHz
Accuracy <i>(under Meas Setup)</i>	High
10 MHz Out <i>(under System, Reference)</i>	ON
Freq Ref <i>(under System, Reference)</i>	Int

5. Both the signal source and the PSA must warm up for at least 2 hours.
6. Look at the calibration report for the step attenuator. The metrology lab that characterized the attenuator should have listed on the report a note about which 11713A Attenuator Driver switch was activated to obtain the 40 dB data. This is important since the 8496G has two 40 dB steps, and you must assure you know which switch to press to enable the calibrated 40 dB step. The other 40 dB attenuator step is used only to achieve the 80 to 110 dB steps.
7. Using the step attenuator calibration data, fill in [Table 8-4](#), “[Measurement Test Record](#),” Atten Calibration Value and Atten Uncert with the reference attenuation value (the value the cal lab measured) and the measurement uncertainty for each attenuator step.
8. Select the 0 dB setting on the step attenuator.
9. Press **Meas Setup**, **Set Ref** key. Assure reading is 0.000 dB. If not, press **Set Ref** key again.

10. On the PSA, press **Measure Control**, select **Measure Single**. This will allow you to control when the measurement is taken so you can assure the proper step attenuation is set before beginning the measurement. You will need to press the **Restart** key each time you want to make a measurement.

NOTE

Do not Preset the PSA, or use the Frequency Counter function. If you do, the instrument will require at least 30 minutes for stabilization.

Perform the following steps for each measurement value:

1. Change the step attenuator to the next higher value and press the **Restart** key.
2. Record the measured value in [Table 8-4](#) under Attenuator Measured.
3. Set the step attenuator back to 0 dB (the reference setting). If the displayed reference is within 0.002 dB of zero keep the recorded result and continue. If the displayed reference is greater than 0.002 dB, press the **Set Ref** key and start the measurement over.
4. Repeat steps 1 through 3 and continue increasing the step attenuator value.
5. When all attenuator steps have been measured, calculate the linearity error by:
Error = Attenuator Measured - Attenuator Cal Value. Fill in Linearity Error column of [Table 8-4](#).
6. Compare the linearity error to the specification. Be sure to consider the \pm attenuator uncertainty when determining pass or fail.

Table 8-4 Measurement Test Record

Reference Attenuator Cal Data S/N				
Atten Calibration Value (dB)	Atten Uncert (\pm dB)	Attenuator Measured (dB)	Linearity Error (dB) (Attenuator Measured – Atten Cal value)	Specification (\pm dB)
0	0	0	0	0
				0.014
				0.019
				0.024
				0.029
				0.034

Table 8-5 Example Test Record

Reference Attenuator Cal Data S/N				
Atten Calibration Value (dB)	Atten Uncert (\pm dB)	Attenuator Measured (dB)	Linearity Error (dB) (Attenuator Measured – Atten Cal value)	Specification (\pm dB)
0	0	0	0	0
9.989	0.006	9.983	- 0.006	0.014
20.042	0.006	20.044	0.002	0.019
30.025	0.006	30.022	- 0.003	0.024
40.194	0.006	40.190	- 0.004	0.029
50.175	0.011	50.169	- 0.006	0.034

Relative Tuned RF Level Measurement

Definition

This verification test checks the relative TRFL measurement accuracy of the PSA spectrum analyzer that is part of the measuring receiver.

The PSA spectrum analyzer stability, linearity, attenuator switching accuracy and preamp flatness are major contributors to the specification. However, DUT stability, or stability of the signal source providing stimulus to the DUT are also key contributors to meeting the relative TRFL specification.

This test differs from the linearity verification test in that this test is performed at 3 different PSA attenuator settings and with the PSA preamp on and off. Also the effects of range switching are included.

Specification

See the PSA Specifications Guide, TRFL Specification Nomenclature, for a graphical representation of residual noise threshold and minimum and maximum power.

Relative Measurement Accuracy is a nominal value and not a hard specification.

Residual Noise threshold to max power:

$$\pm (0.015 \text{ dB} + 0.005 \text{ dB}/10 \text{ dB step}) \text{ nominal}$$

Minimum power to residual noise threshold:

$$\pm [(\text{cumulative error} + 0.0012) \times (\text{input power} - \text{Residual Noise Threshold Power})^2]$$

Residual Noise Threshold Power (dBm): Minimum power + 30 dB

Range 2 Uncertainty: $\pm 0.031\text{dB}$

Add this value when the measuring receiver enters the range 2 state. Range 2 is entered when the range 1 signal to noise ratio (SNR) falls between 50 and 28 dB. The SNR value is tuning band dependant. A prompt of “Range 2” on the PSA display will indicate that the measuring receiver is in Range 2.

Range 3 Uncertainty: $\pm 0.031\text{dB}$

Add this value in addition to the range 2 uncertainty when the measuring receiver enters the range 3 state. Range 3 is entered when the range 2 signal to noise ratio (SNR) falls between 50 and 28 dB. The SNR value is tuning band dependant. A prompt of “Range 3” on the PSA display will indicate that the measuring receiver is in Range 3.

Specs apply to following conditions:

Frequency must be set manually. (Do not use the measuring receiver Frequency Count measurement).

Accuracy mode must be set to High.

Range 3 Switch Delay must be ON. Key path: **Meas Setup, More**

Description

A highly calibrated step attenuator is used in conjunction with a highly stable signal source to provide a 50 MHz test signal of varying amplitudes to the PSA.

The PSA is placed in the Measuring Receiver mode, and the TRFL level measurement is selected.

The step attenuator is set to 0 dB and a reference measurement is taken.

The step attenuator is stepped from 0 to -110 dB and the amplitude at each step recorded.

The difference between the expected attenuation value as recorded on the step attenuator calibration report, and the measured value, is the linearity accuracy.

NOTE

For E4446A, E4447A and E4448A:

If the following procedure is modified to test at frequencies above 3.05 GHz, a stabilization period is required for the Option 123, preselector bypass.

When performing measurements across the following frequency band breaks, a single 10 minute stabilization period is required to meet specification after entering the new frequency band.

Band breaks occur at the following frequencies:

Band 0 to Band 1	3.05 GHZ
Band 1 to Band 2	6.6 GHz
Band 2 to Band 3	13.2 GHz
Band 3 to Band 4	19.2 GHz
Band 4 to Band 5	26.8 GHz
Band 5 to Band 6	31.15 GHz
Band 6 to Band 7	41 GHz

Table 8-6 Test Equipment

Instrument	Critical Specifications (for this test)	Recommended Model
Synthesized Signal Generator	Frequency 50 MHz Amplitude drift with temperature: Must not drift > 0.01 dB /degree C	Agilent E8257D with UNR or UNX (ultra low phase noise performance) and option 1EH, (Improved Harmonics below 2 GHz)
Calibrated Attenuator	0 to 50 dB range in 10 dB steps. Calibrated at a metrology lab at 50 MHz. VSWR at 50 MHz: <1.05:1 Example of calibration detail for the attenuator used in this test: “Using a dual-synthesizer, parallel IF-substitution method. NIST traceability achieved through a calibrated 1 kHz Ratio transformer. Cal frequency 50 MHz. A minimum of six measurements were made at each attenuator setting to find the mean value of “measured change in insertion loss” and to estimate the Standard Deviation of this Mean.” Also see Table 8-10, “Example Test Record,” for an example of calibrated attenuation and attenuator uncertainty values.	Agilent 8496G
10 dB Attenuator (2 each)	Used to minimize mismatch uncertainty. Connected to both ports of the step attenuator.	Agilent 8491A
Attenuator Switch Driver	Used to drive attenuator	Agilent 11713A
Cable, 3.5 mm (m) to 3.5 mm (m)	High quality cable that is repeatable (can be bumped or bent slightly and not cause measured value to change). DC to 26.5 GHz 92 cm (36 inches) Insertion loss ~2 dB	Agilent 8120-4921

Table 8-6 Test Equipment

Instrument	Critical Specifications (for this test)	Recommended Model
Cable, BNC (m) to BNC (m)	For connecting time base of PSA to source 10 MHz input. 120 cm (48 inches long)	Agilent 10503A
Adapters		
3.5 mm (f) to 2.4 mm (f)	For source output or PSA input on high frequency models	Agilent 11901B
3.5 mm (f) to 3.5 mm (f)	For output of 20 GHz source or input to E4440A opt BAB	1250-1749
Type N (m) to 3.5 mm (f) 2 or 3 required	For connection to fixed attenuators. Also, if PSA has type N input connector, this adapter is required	1250-1744

Test Setup

Figure 8-2 Relative TRFL Measurement Test Setup

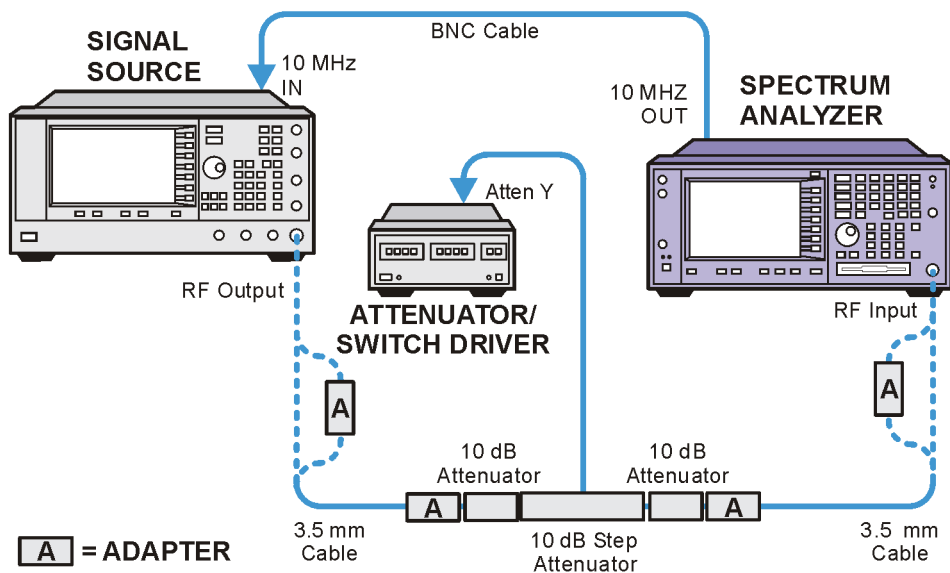

Test Procedure

1. See [Figure 8-2](#). When connecting equipment, assure proper connector care and connector torque settings are followed. SMA/3.5mm cable connectors are to receive 8 inch-pounds of torque. All connections must be cleaned with alcohol.

2. **Preset** the signal source and the PSA.
3. On the PSA, perform the **Auto Align** by pressing **System, Alignments, Align All Now**.
4. Initialize the test equipment parameters as follows:

Table 8-7 Signal Generator Settings

Parameter	Setting
Frequency	50 MHz
Level	+10 dBm
RF	On

Table 8-8 PSA Settings

Parameter	Setting
Mode	Measuring Receiver
Measure	Tuned RF Level
Frequency <i>Note: Do not use the Frequency Counter function. You must press the Frequency key and set the frequency manually.</i>	50 MHz
Accuracy <i>(under Meas Setup)</i>	High
Range 3 Switch Delay <i>(under Meas Setup, More)</i>	ON
10 MHz Out <i>(under System, Reference)</i>	ON
Freq Ref <i>(under System, Reference)</i>	Int

5. Both the signal source and the PSA must warm up for at least 2 hours.
6. Look at the calibration report for the step attenuator. The metrology lab that characterized the attenuator should have listed on the report a note about which 11713A Attenuator Driver switch was activated to obtain the 40 dB data. This is important since the 8496G has two 40 dB steps, and you must assure you know which switch to press to enable the calibrated 40 dB step. The other 40 dB attenuator step is used only to achieve the 80 to 110 dB steps.
7. Using the step attenuator calibration data, fill in [Table 8-9, “Measurement Test Record,”](#) Atten Calibration Value and Atten Uncert with the reference attenuation value (the value the cal lab

measured) and the measurement uncertainty for each attenuator step.

8. Select the 0 dB setting on the step attenuator.
9. Press **Meas Setup**, **Set Ref** key. Assure reading is 0.000 dB. If not, press **Set Ref** key again.
10. On the PSA, press **Measure Control**, select **Measure Single**. This will allow you to control when the measurement is taken so you can assure the proper step attenuation is set before beginning the measurement. You will need to press the **Restart** key each time you want to make a measurement.

NOTE

Do not Preset the PSA, or use the Frequency Counter function. If you do, the instrument will require at least 30 minutes for stabilization.

Perform the following steps for each measurement value:

1. Change the step attenuator to the next higher value and press the **Restart** key.
2. Record the Tuned RF Level value in [Table 8-9](#) under TRFL Measured.
3. Repeat steps 1 and 2 and continue increasing the step attenuator value.
4. When the step attenuator is set to approximately 60 dB, the measuring receiver will automatically calibrate range 2 before performing a measurement.
5. When the step attenuator is set to approximately 80 dB, the measuring receiver will automatically calibrate range 3 before performing a measurement. This will take about 5 minutes since the Range 3 Switch delay is set to ON.
6. When all attenuator steps have been measured, calculate the TRFL measurement error by:
Error = TRFL Measured - Attenuator Cal Value. Fill in Error column of [Table 8-9](#).
7. Compare the TRFL Error to the specification. Be sure to consider the \pm attenuator uncertainty.

NOTE

If you wish to start a new series of measurements, and want to clear the Cal Factor 2 and Cal Factor 3 values, press **Measure Setup**, and toggle the IF BW to 75 Hz then back to 10 Hz. Press **Set Reference** again.

Table 8-9 Measurement Test Record

Reference Attenuator Cal Data S/N					
Atten Calibration Value (dB)	Atten Uncert (\pm dB)	TRFL Measured (dB)	TRFL Error (dB) (TRFL Measured – Atten Cal value)	Specification (\pm dB)	Range
0	0	0	0	0	
				0.020	1
				0.025	1
				0.030	1
				0.035	1
				0.040	1
				0.076	2
				0.081	2
				0.117	3
				0.122	3
				0.127	3
				0.247	3

Table 8-10 Example Test Record

Reference Attenuator Cal Data					
S/N					
Atten Calibration Value (dB)	Atten Uncert (± dB)	TRFL Measured (dB)	TRFL Error (dB) (TRFL Measured – Atten Cal value)	Specification (± dB)	Range
0	0	0	0	0	
9.989	0.006	9.983	– 0.006	0.020	1
20.042	0.006	20.044	0.002	0.025	1
30.025	0.006	30.022	– 0.003	0.030	1
40.194	0.006	40.190	– 0.004	0.035	1
50.175	0.011	50.169	– 0.006	0.040	1
60.233	0.011	60.218	– 0.015	0.076	2
70.212	0.010	70.202	– 0.010	0.081	2
80.339	0.010	80.324	– 0.015	0.117	3
90.318	0.0220	90.298	– 0.020	0.122	3
100.370	0.022	100.349	– 0.021	0.127	3
110.370	0.022	110.278	– 0.092	0.247	3

A

- Accuracy key, 183
- active license key, 32
 - how to locate, 32
- AM Depth key, 159
- AM Depth Measurement, 81, 189
- AM Depth Measurement
 - Concepts, 285
 - Measurement Technique, 285
- Amplitude Modulation Concepts, 276
- AMPLITUDE Y Scale, 170, 176, 181, 193, 208, 220, 252
- AMPLITUDE Y Scale key, 236, 243, 248, 257, 261
 - Frequency Counter, 67
- Audio AC Level key, 166
- Audio AC Level Measurement, 112, 252
- Audio AC Level Measurement
 - Concepts, 290
 - Measurement Technique, 290
 - Purpose, 290
- Audio Distortion key, 167
- Audio Distortion Measurement, 114, 256
- Audio Distortion Measurement
 - Concepts, 291
 - Measurement Technique, 291
 - Purpose, 291
- Audio Frequency key, 165
- Audio Frequency Measurement, 109, 248
- Audio Frequency Measurement
 - Concepts, 290
 - Measurement Technique, 290
 - Purpose, 290
- Audio Ranging key, 146
- Audio SINAD key, 168
- Audio SINAD Measurement, 116, 260
- Audio SINAD Measurement
 - Concepts, 292
 - Measurement Technique, 292
 - Purpose, 292
- Avg Mode key, 173, 178, 201, 214, 226, 234, 240, 247, 250, 259, 263
 - Meas Setup
 - Frequency Counter, 67
- Avg Number key, 173, 178, 200, 213, 226, 235, 240, 246, 251, 254, 255, 259, 263
 - Meas Setup
 - Frequency Counter, 67

C

- Cal Date key, 136
- Cal Factor key, 138
- Calibrate
 - Calibrate PM, 49
 - Edit Cal Factors, 48
 - Load Cal Factors, 48, 49
 - Range CalFactors, 52
 - Recalibrate PM, 51
 - Zero PM, 49
- Calibrate Power Meter key, 128
- Capture Time key, 202, 215, 228
- Center Frequency key, 142
- Channel key, 129
- Choose Option key, 31
- Clear Power Sensor key, 137
- code, programming
 - compatibility across PSA modes, 120, 122
 - compatibility, PSA series versus VSA, 123
- commands
 - compatibility across PSA modes, 120, 122
 - CONFigure, 153
 - FETCh, 154
 - MEASure, 153
 - PSA series versus VSA
 - compatibility, 123
 - READ, 154, 155
 - compatibility, programming
 - across PSA modes, 120
 - PSA series versus VSA, 123
 - CONFigure commands, 153
 - Conn Mode key, 130
- D
 - default values, setting remotely, 153
 - Delete All Points key, 137
 - Delete Point key, 138
 - deleting an
 - application/personality, 27
 - Det/Demod key, 125
 - Detector, 125
 - Detector key, 125
 - Peak Hold, 126
 - Digital Modulation key, 149
 - Display Mode key, 170, 176, 181, 193, 208, 220, 231, 236, 243, 248, 252, 257, 261
 - Frequency Counter, 67
 - Display Unit key, 170, 176, 181, 193, 208, 221, 231, 237, 243, 249, 253, 257, 261
 - Frequency Counter, 67

E

- E5810A LAN/GPIB gateway, 358
- Edit Cal Factors key, 138
- electrostatic discharge (ESD)
 - protecting against, 57
- EPM power meters, 358
- Ext Atten key, 143
- Ext Audio Atten key, 145
- Ext RF Atten key, 146

F

- Fast Mode key, 203, 216, 228, 235, 241
- FETCh commands, 154
- File key
 - Load, 151
 - Save, 151
- FM De-Emphasis key, 126
- FM Deviation key, 160
- FM Deviation Measurement, 86, 204
- FM Deviation Measurement
 - Concepts, 286
 - Measurement Technique, 286
 - Purpose, 286
- FREQUENCY Channel key, 142
 - Center Frequency, 142
- Frequency Counter key, 156
- Frequency Counter
 - Measurement, 65, 169
 - adjust measurement settings, 66
 - adjust the display, 67
 - example, 68
- Frequency Counter Measurement
 - Concepts, 267
 - Measurement Technique, 267
 - Purpose, 267
- Frequency key, 138
- Front-Panel key
 - AMPLITUDE Y Scale, 170, 176, 181, 193, 208, 220, 236, 243, 248, 252, 257, 261
 - Det/Demod, 125
 - FREQUENCY Channel, 142
 - Input/Output, 143
 - Meas Control, 148
 - Meas Setup, 172, 178, 183, 199, 212, 225, 233, 238, 245, 250, 254, 259, 263
 - MEASURE, 152
 - MODE, 149
 - SPAN X Scale, 190, 205, 218
 - Trace/View, 198, 212, 224

G

- Gate Time key, 172
- Meas Setup
 - Frequency Counter, 67
- GPIB Address key, 131

H

- Highpass Filter key, 126

I

- IF BW key, 183, 199, 212, 225, 233, 238, 245
- IF BW Type key, 199, 213, 225, 233, 238, 245
- initial signal connection, 48
- Input Attenuation key, 145
- Input Port key, 143
- Input Preamp key, 144
- Input/Output key, 143
 - Audio Ranging, 146
 - Ext Atten, 143
 - Ext Audio Atten, 145
 - Ext RF Atten, 146
 - Input Attenuation, 145
 - Input Port, 143
 - Int Preamp, 144
 - Microwave Preselector, 144
 - RF Input Ranging, 144
- Install Now key, 31
- Installing and Obtaining a license key, 31
- installing measurement personalities, 27
- IP Address key, 130

L

- LAN/GPIB gateway, 358
- license key
 - obtaining and installing, 31
- Load key, 151
- loading an
 - application/personality, 27
- Lowpass Filter key, 127

M

- major functional keys, 61
- Making AM Depth
 - Measurements, 81
- Making Audio AC Level
 - Measurement, 112
- Making Audio Distortion
 - Measurement, 114
- Making Audio Frequency
 - Measurement, 109

- Making Audio SINAD
 - Measurement, 116
- Making FM Deviation
 - Measurements, 86
- Making Frequency Counter
 - Measurements, 65
- making measurements, 59
 - PC User Interface, 347
- making measurements,
 - equipment setup, 48
- Making Modulation Distortion
 - Measurements, 101
- Making Modulation Rate
 - Measurements, 96
- Making Modulation SINAD
 - Measurement, 105
- Making PM Deviation
 - Measurements, 91
- Making RF Power Measurement, 69
- Making Tuned RF Level
 - Measurement, 73
- Meas Control key, 148
 - Measure, 148
 - Cont, 148
 - Single, 148
 - Pause, 148
 - Resume, 148
 - Restart, 149
- Meas Setup key, 172, 178, 183, 199, 212, 225, 233, 238, 245, 250, 254, 259, 263
 - Frequency Counter, 66
- MEASure commands, 153
- MEASURE key, 152
 - AM Depth, 159
 - Audio AC Level, 166
 - Audio Distortion, 167
 - Audio Frequency, 165
 - Audio SINAD, 168
 - FM Deviation, 160
 - Frequency Counter key, 156
 - Modulation Distortion, 163
 - Modulation Rate, 162
 - Modulation SINAD, 164
 - PM Deviation, 161
 - RF Power, 157
 - Tuned RF Level, 158
- Measurement key, 169
- measurement key flow, 297
- measurement keys
 - AM Depth Measurement, 189
 - Audio AC Level Measurement, 252
 - Audio Distortion Measurement, 256

- Audio Frequency Measurement, 248
- Audio SINAD Measurement, 260
- FM Deviation Measurement, 204
- Frequency Counter
 - Measurement, 169
- Modulation Distortion
 - Measurement, 236
- Modulation Rate Measurement, 230
- Modulation SINAD
 - Measurement, 242
- PM Deviation Measurement, 217
- RF Power Measurement, 175
- Tuned RF Level Measurement, 180
- Measurement Procedure
 - Frequency Counter
 - Measurement, 66
 - RF Power Measurement, 69
- Measurement Technique
 - AM Depth Measurement
 - Concepts, 285
 - Audio AC Level Measurement
 - Concepts, 290
 - Audio Distortion Measurement
 - Concepts, 291
 - Audio Frequency Measurement
 - Concepts, 290
 - Audio SINAD Measurement
 - Concepts, 292
 - FM Deviation Measurement
 - Concepts, 286
 - Frequency Counter
 - Measurement Concepts, 267
 - Modulation Distortion
 - Measurement Concepts, 288
 - Modulation Rate Measurement
 - Concepts, 287
 - Modulation SINAD
 - Measurement Concepts, 289
 - PM Deviation Measurement
 - Concepts, 286
 - RF Power Measurement
 - Concepts, 269
 - Tuned RF Level Measurement
 - Concepts, 271
- measurements
 - setting default values remotely, 153
- Measuring Receiver key, 149

- Measuring Receiver System, 24
 - Microwave Preselector key, 144
 - missing options, 27
 - MODE key, 149
 - Measuring Receiver, 149
 - Spectrum Analysis key, 149
 - Model No. key, 130
 - Model Number key, 139
 - Modulation Basic Concepts, 276
 - Modulation Distortion key, 163
 - Modulation Distortion
 - Measurement, 101, 236
 - Modulation Distortion
 - Measurement Concepts, 288
 - Measurement Technique, 288
 - Purpose, 288
 - Modulation Mode key, 128
 - Modulation Rate key, 162
 - Modulation Rate Measurement, 96, 230
 - Modulation Rate Measurement
 - Concepts, 287
 - Measurement Technique, 287
 - Purpose, 287
 - Modulation SINAD key, 164
 - Modulation SINAD
 - Measurement, 105, 242
 - Modulation SINAD Measurement
 - Concepts, 289
 - Measurement Technique, 289
 - Purpose, 289
- N**
- N5531S, 24
 - N5531S Block Diagram, 266
- O**
- Option key, 139
 - options
 - loading/deleting, 27
 - options not in instrument
 - memory, 27
- P**
- Peak Hold key, 126
 - performance verification, 364
 - personality options not in instrument, 27
 - Phase Modulation Concepts, 280
 - PM Dev Only key, 203, 216, 229
 - PM Deviation key, 161
 - PM Deviation Measurement, 91, 217
 - PM Deviation Measurement
 - Concepts, 286
 - Measurement Technique, 286
 - Purpose, 286
 - Point key, 138
 - Power Meter Config key, 129
 - Power Meter Firmware Version key, 131
 - Power Meter key, 128
 - Power Meter Options key, 132
 - Power Sensor key, 136
 - Preset key
 - Frequency Counter, 66
 - programming
 - compatibility among PSA modes, 120, 122
 - compatibility, PSA series versus VSA, 123
 - PSA series versus VSA (programming compatibility), 123
 - Purpose
 - Audio AC Level Measurement Concepts, 290
 - Audio Distortion Measurement Concepts, 291
 - Audio Frequency Measurement Concepts, 290
 - Audio SINAD Measurement Concepts, 292
 - FM Deviation Measurement Concepts, 286
 - Frequency Counter
 - Measurement Concepts, 267
 - Modulation Distortion
 - Measurement Concepts, 288
 - Modulation Rate Measurement
 - Concepts, 287
 - Modulation SINAD
 - Measurement Concepts, 289
 - PM Deviation Measurement
 - Concepts, 286
 - RF Power Measurement
 - Concepts, 269
 - Tuned RF Level Measurement
 - Concepts, 271, 285
- R**
- Range Hold key, 184
 - Range Switching key, 184
 - Ratio Mode key, 171, 177, 182, 194, 209, 221, 232, 238, 244, 250, 253, 258, 262
 - Frequency Counter, 67
 - Ratio Ref key, 171, 177, 182, 194, 209, 221, 232, 237, 244, 249, 253, 258, 262
 - Frequency Counter, 67
 - RBW key, 174
 - Meas Setup
 - Frequency Counter, 67
 - READ commands, 154, 155
 - Recall Power-On Default key, 139
 - Ref Position key, 191, 196, 206, 210, 219, 223
 - Ref Value key, 191, 195, 206, 211, 219, 223
 - Reference CF key, 140
 - Resolution key, 132
 - RF Input Ranging key, 144
 - RF Power key, 157
 - RF Power Measurement, 69, 175
 - RF Power Measurement
 - Concepts, 269
 - Measurement Technique, 269
 - Purpose, 269
- S**
- Save key, 151
 - Scale Coupling key, 192, 196, 207, 211, 220, 224
 - Scale/Div key, 190, 195, 205, 210, 218, 222
 - Serial No. key, 132
 - Serial Number key, 141
 - Set Ref key, 185, 186
 - Show Setup key, 133
 - SPAN X Scale, 190, 205, 218
 - Spectrum Analysis key, 149
 - System Block Diagram, 25
 - System Overview, 24
 - System Requirements, 37
 - PC Hardware Requirements, 358
 - PC Software Requirements, 358
 - Power Meter Requirements, 37
 - PSA Requirements, 37
 - Sensor Requirements, 38
- T**
- test equipment, setup, 48
 - Time Out key, 133
 - Trace/View key, 198, 212, 224
 - TRFL Calibrate key, 185
 - Trig Source key, 201, 214, 227
 - Tuned RF Level key, 158
 - Tuned RF Level Measurement, 73, 180
 - Tuned RF Level Measurement
 - Concepts, 271
 - Measurement Technique, 271
 - Purpose, 271, 285
 - Tuning key
 - Meas Setup

Frequency Counter, [66](#)
Tuning Mode key, [172](#)

U

Uninstall Now, [32](#)
uninstalling measurement
personalities, [27](#)
Update Power-On Default key,
[141](#)
Use Power Meter key, [179](#)

V

Verify Power Meter Connection
key, [133](#)
VSA versus PSA series
(programming compatibility),
[123](#)

Z

Zero & Cal Power Meter key, [134](#)
Zero Power Meter key, [135](#)